

**SHURE**<sup>®</sup>

LEGENDARY  
PERFORMANCE™

# AUDIO SYSTEMS GUIDE

**VIDEO AND FILM  
PRODUCTION**

By Chris Lyons



A Shure Educational Publication

# AUDIO SYSTEMS GUIDE

VIDEO AND FILM  
PRODUCTION

By Chris Lyons



## Table of Contents

<b>Introduction</b> .....	4
<b>Part One: Microphones</b> .....	5
The Audio Chain .....	5
Microphone Characteristics.....	6
Frequency Response .....	7
Directionality .....	8
Transducer Types .....	9
Electrical Output.....	11
Physical Design .....	12
<b>Part Two: Wireless Systems</b> .....	17
Wireless Components .....	17
<i>Portable and Camera Mount Receivers</i> .....	17
<i>Spectrum for Wireless Microphones</i> .....	18
<i>Frequency Selection</i> .....	19
<i>Navigating the New Wireless Landscape</i> .....	20
<b>Part Three: Audio Mixers, Interfaces, and Recorders</b> .....	21
Connecting Microphones to Video Cameras and Recorders .....	21
<i>Audio Interfaces</i> .....	21
<i>Audio Mixers</i> .....	21
<i>Using an External Microphone</i> .....	21
<i>Recording Directly to Your Computer</i> .....	22
<i>Using an External Audio Recorder</i> .....	23
<i>Mic and Line – What Do They Mean?</i> .....	24
<i>Other Recorder Features</i> .....	24
<i>Dealing With Automatic Gain Control</i> .....	24
Cables and Connections .....	25
<b>Part Four: Common Applications</b> .....	27
General Guidelines.....	27
Common Applications and Audio Suggestions .....	29
<b>Part Five: Troubleshooting</b> .....	39
<b>Part Six: Pre-Shoot Checklist</b> .....	41
<b>Part Seven: Conclusion and Learning More</b> .....	42
<b>More Shure Resources</b> .....	43
<b>About The Author</b> .....	43
<b>Product Selection Charts</b> .....	44

# Contents

## Introduction

*Keeping up with the technological advancements of audio for video and film production is a real challenge. The good news is that the equipment used for video and film production is becoming increasingly sophisticated, intuitive, and more accessible every day; people are getting involved with video projects of all kinds and on all mediums — whether it's for personal entertainment, business or educational purposes.*

*While technology changes each and every year, there is one constant: **the audio is just as important as the visual**. No matter how creative and well-executed the visual aspects of a production may be, and regardless of whether it's posted on YouTube, burned to a DVD or appears on a big, little or mobile screen, the viewer's experience can be utterly ruined by lackluster audio. To a greater degree than most people realize, sound can “make or break” any video or film project.*

*This booklet is intended to help anyone involved with video or film projects improve the audio quality of their productions. It is not intended as a comprehensive study of the subject of audio. The booklet's goal is to provide a general knowledge of audio tools, practical advice, and helpful tips — all with the express purpose of ensuring the sound portions of your efforts are as clear, understandable, and high quality as possible.*

*As a leader in audio technology, Shure has played a major role providing tools and techniques for delivering high quality audio for video and film. No matter what your involvement with video or film production may be, we're confident that Shure products and our application assistance can help you achieve the highest possible level of audio excellence in your work.*

*We hope this booklet will help you improve the sound quality of your productions, whatever they might be and however you share them with the world.*

# Introduction



## PART ONE

# Getting Started: The Basics of Audio For Video

## A SOUND BACKGROUND The Audio Chain

Although we seldom think about it, the recording and playback of audio for video involves a series of processes. First, the sound must be captured by a microphone; next it must be recorded on a storage medium; then it must be amplified and played back through speakers or headphones so that it can be heard by a listener. The devices that perform these functions are collectively known as the audio chain.

When you shoot a video clip with your smartphone and show it to someone, the recording and playback process is very straightforward: press the Record button, talk into the camera, and press the Stop button when finished. The capture, recording, and playback of sound are all performed by the same device.



Recording on Smartphone



Playback on Smartphone

In the world of professional audio-for-video and audio-for-film, however, things are different. First of all, the capture, recording, and playback processes are usually handled by different pieces of equipment. Second, there is an additional intermediate stage in which the audio is edited to eliminate mistakes or fit a particular time constraint, processed to enhance sound quality, and formatted to suit a particular distribution medium such as online video or DVD.

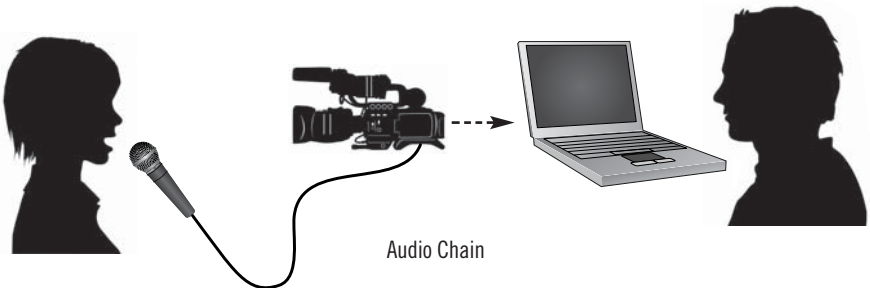

Audio Chain

## Audio Systems Guide for VIDEO AND FILM PRODUCTION

Today, the editing and processing steps are performed by software on a computer. Despite continuing improvements in the power and sophistication of audio and video editing software, however, it is usually difficult or impossible to take bad audio and make it good. To deliver great audio, you must record great audio. The purpose of this book is to help you do that.

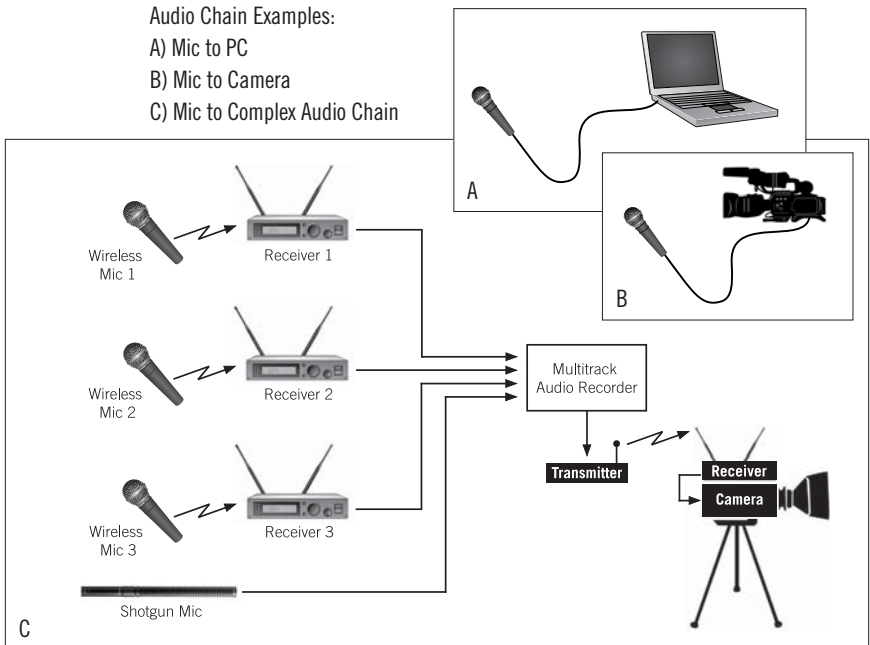

Complex audio chain with multiple wired and wireless mics, multitrack recorder, and wireless audio feed to camera.

## MICROPHONE Characteristics

The first step in getting the sound of someone's voice into your video or film is the microphone. Microphones serve a very basic purpose: to change acoustic energy (sound) to electrical energy.

They convert sound waves into an audio signal which can be recorded, edited, distributed, and amplified for playback. Since the microphone's function is so basic, you might well ask why there are so many different kinds of microphones. It's because some types of microphones are better suited to certain uses than others, just as some cameras are better suited for use on a tripod in a well-lit studio while others are better for handheld use with available light.

If you are familiar with the different types of microphones, and how and when to use them to the best effect, your productions will start sounding more professional.

## Frequency Response

How a particular microphone sounds is largely determined by its relative sensitivity to certain areas of the frequency range. This characteristic is called its *frequency response*, and is represented by a graph. Microphones intended for voice applications almost always have a shaped frequency response, with the mic being somewhat more sensitive to the upper midrange and somewhat less sensitive to low frequencies. The shaped frequency response makes dialogue more intelligible and reduces pickup of low frequency noise often caused by air handling systems.

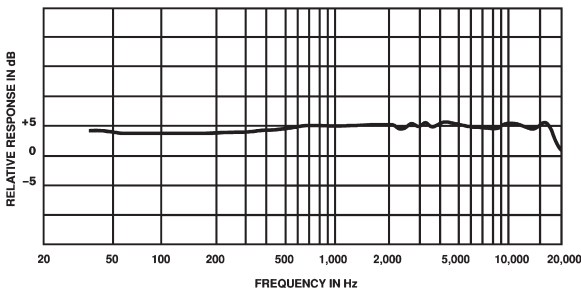

Flat Frequency Response

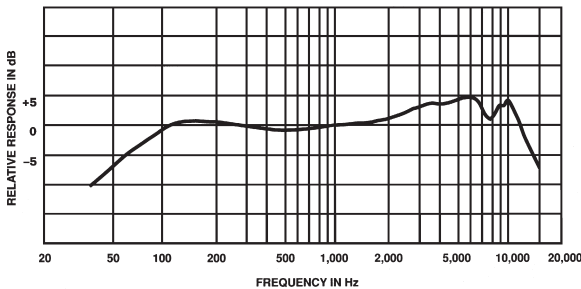

Shaped Frequency Response

It's important to note that the sound of the microphone can vary significantly depending on where it is positioned relative to the talker, whether it is hidden under a layer of cloth, etc. Experience with a particular model of microphone will reveal which positions deliver the most favorable results.

## Directionality

Directionality is one of the most frequently misunderstood characteristics of a microphone. Simply put, directionality describes how a microphone responds to sounds arriving from different directions or angles. Some microphones pick up sounds equally well from all angles, while others favor sounds from a particular direction. Understanding the significance of a microphone's directionality is vital to getting the most from its capabilities in any given miking situation.

The most common way of illustrating a microphone's directionality is with a polar pattern. This is a circular graph, which illustrates the relative sound pickup from different directions. Although many different polar patterns are possible, the most common ones fall into two general categories: *omnidirectional* and *unidirectional*.

**Omnidirectional** – An omnidirectional microphone picks up sound equally from all directions (the prefix “omni” means “all”). An omni mic will pick up sound from above, below, in front of, behind, and to the side of the mic in a 360 degree sphere. The polar pattern for an omni, accordingly, is roughly circular. This can be advantageous, since one omnidirectional microphone can be used to pick up voices from several directions, as long as each person talking is approximately the same loudness and the same distance from the microphone. Also, an omnidirectional mic picks up some of the ambience of the situation, which can help to reinforce the visual setting. If the scene takes place on a street corner, some traffic sound is desirable, as long as it does not overwhelm the dialogue. The handheld microphones used by field news and sports reporters are usually omnidirectional, allowing the reporter and interviewee to be picked up by one microphone held between them, and delivering a certain amount of ambient sound.

There are some drawbacks to consider when using omnidirectional mics, however. First, since they pick up sounds equally well from all directions, they may also pick up undesired background noises (doors slamming, excessive traffic noise, people talking behind you, etc.). Second, they tend to pick up greater amounts of room reverberation when used in rooms that have hard-surfaced walls and floors. This can sometimes result in a diffuse, hollow, “inside a barrel” sound. This effect may be minimized by moving the microphone closer to the source and turning down the input level control on the recorder to compensate. A third drawback to omnidirectional mics is that, when fed through a loudspeaker system for sound reinforcement, they tend to produce feedback easily. (We'll discuss feedback and room reverberation in more detail in the Troubleshooting section.)

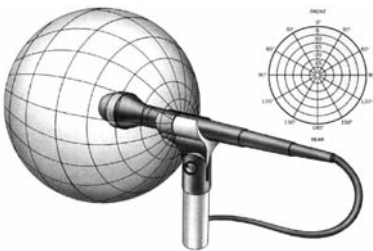

Omnidirectional Microphone

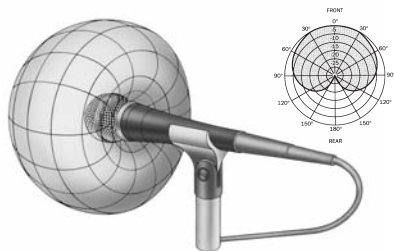

Cardioid (Unidirectional) Microphone



**Unidirectional** – A unidirectional microphone rejects sound coming from behind the mic while still picking up sound from the front. For this reason, unidirectional microphones pick up less background noise and room reverberation and are less susceptible to feedback when used with loudspeaker systems. There are different kinds of mics that fall into this category, each one having a slightly different polar pattern and its own set of advantages and disadvantages.

By far the most common type of unidirectional microphone is the cardioid, so named because its polar pattern resembles a heart-shaped figure. Most cardioid mics will pick up less than half as much sound from the sides as from the front, and less than one tenth as much sound from the rear as from the front. So, the cardioid mic tends to pick up more of the desired sound (where you are pointing the mic) and less of the undesired sound (where you are not pointing the mic).

Other unidirectional types such as the *supercardioid* and *hypercardioid* have progressively greater rejection of sounds from the sides, but pick up more sound from the rear. Using these more directional patterns requires that the talker be more careful about staying directly “on mike” and not straying off to the sides, where the microphone’s sensitivity drops off rapidly. These also allow some pickup of sounds “behind the mic, which may or may not be a problem depending on the recording environment.

Most types of microphones are available in both omnidirectional and unidirectional versions. Lavalier microphones are usually omnidirectional, although unidirectional models are also readily available.

The shotgun microphone is a special type with an extremely directional polar pattern. Their narrow pickup angle makes them popular for sporting events, TV and film production, and other situations where it is impractical or undesirable for the subject to wear or hold a microphone. It’s important to note that shotgun mics do not amplify sound; they merely reject sound that comes from the sides, which allows the sound coming from in front of the mic to be heard more clearly — even if the sound is many feet away.

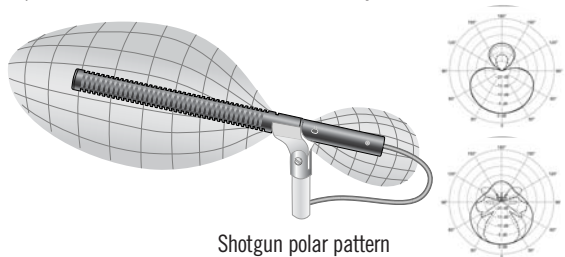

Shotgun polar pattern

**Directionality Tip:** Check the directionality of a microphone before you purchase or use it. The polar pattern will help you determine if it serves your application need.

## Transducer Types

Again, microphones serve a single purpose: to convert sound waves into an electrical signal. The part of the mic that actually performs the conversion is called the *transducer* or *cartridge*. Different types of transducers do this in different ways, and each type of transducer has certain characteristics that make it more or less suitable for various applications. For the most part, two types of transducers are used in microphones for audio-visual productions: the *dynamic* and the *condenser*.

## Audio Systems Guide for VIDEO AND FILM PRODUCTION

Dynamic microphones use a simple magnet and coil of wire to convert sound waves into a signal. Here's how it works: a thin diaphragm with a coil of fine wire attached vibrates when struck by sound waves. This causes the coil of wire to move back and forth around a magnet, creating a small amount of electricity, which flows out of the microphone's connector and through the microphone cable.

Good quality dynamic mics offer very good sound quality, are very rugged, and will usually tolerate rough handling or exposure to extreme temperatures and humidity. Dynamic microphones cannot be made very small, however, which limits their appeal for on-camera use. For these reasons, many handheld and voiceover microphones are the dynamic type, since the size of the microphone is not a factor.

Condenser microphones (sometimes called electret condenser microphones) use an even thinner diaphragm than the dynamic type stretched tight just above a piece of flat metal or metal-coated ceramic, called a backplate. When a fixed electrical charge is placed on the diaphragm/backplate assembly, its electrical output varies depending on the movements of the diaphragm, which vibrates in response to sound waves. This output signal is extremely weak and subject to outside electrical interference, however, so it must be modified and/or amplified by a circuit called a *preamplifier*. The preamplifier can either be located in the handle of the microphone or in a small outboard electronic tube or pack.

Condenser microphones offer several benefits. The most important of these is that they can be made very small, which is why all miniature lavalier microphones are condenser types. Condensers tend to be very sensitive to the extreme low and high frequencies, and usually have a very crisp, clean sound that enhances dialogue intelligibility as well as many musical instruments. Their built-in preamplifiers allow condenser mics to provide higher output than dynamic mics, meaning that for a given sound level, a stronger electrical signal comes out. This may be helpful when you are trying to record someone who speaks very softly, or who is farther away from the mic.

You'll encounter one inconvenience in using condenser mics, however, in that the preamplifier requires electricity to work. On some microphones, this can come from a battery carried inside the handle of the mic or in the preamplifier pack, but in most cases power must be supplied from the recorder, mixer, or audio interface that the mic is plugged into. This is called *phantom power*.

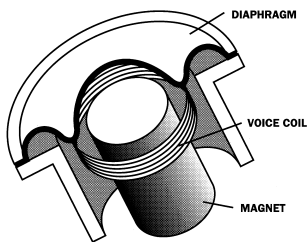

Dynamic Microphone

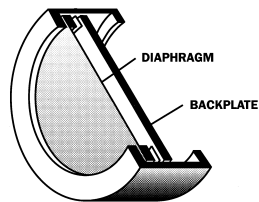

Condenser Microphone

### ***Phantom Power***

Condenser microphones require electrical power to operate (usually between 11 and 48 volts DC). Phantom powering is a method of supplying that power through the microphone cable from a remote supply. This supply can be a stand-alone unit or may be incorporated in the audio recorder, mixer, audio interface, or, in some cases, the camera itself. It is called "phantom" power because it comes from somewhere outside the microphone and is not supplied by a battery.

While it's a popular myth, plugging a dynamic microphone (which doesn't need any power to work) into a mic input jack that is supplying phantom power will not damage the microphone. Professional dynamic mics typically have a balanced output connection, so phantom power cannot harm it or cause it to "burn out." If you connect an unbalanced microphone to an input that is supplying phantom power, you may hear a steady hum or buzz. To get rid of the buzz, simply turn off the phantom power supply.

Phantom power is occasionally referred to as simplex power; the two are one and the same electrically. You may also encounter some European microphones which require a different type of power called A-B power or T power. These are electrically incompatible with phantom power. Microphones which operate on phantom power will not operate on A-B power, and vice-versa. Some professional audio mixers can provide phantom power and A-B power to different mic inputs simultaneously.

## **Electrical Output**

The specifications that relate to connectivity are collectively referred to as the microphone's *electrical output*.

The *sensitivity* or *output level* of a microphone is defined as the voltage of its output signal when it is exposed to a certain sound level. A more sensitive mic puts out a higher voltage than a less sensitive mic, assuming that the incoming sound level is the same. If you try to use a less sensitive microphone on a quiet source, you'll need to turn up the level on your mixer or audio interface to compensate. Depending on how quiet your equipment is, this may create hiss.

The sensitivity of a microphone can be specified as a voltage or in decibels above or below 1 volt. Because microphone signals are typically less than one volt, the decibel figure is a negative number. A higher number means the microphone is more sensitive, while a lower number means the mic is less sensitive.

The sensitivity specification is meaningless unless you know what sound pressure level – or "SPL" – the mic was exposed to when it was measured. Most microphones are tested at a sound pressure level of 94 decibels, also known as one *Pascal*. You might see either notation, but they mean the same thing.

The impedance of the microphone is important because it affects how it interfaces with the next device in the audio chain and its ability to be used with long cables.

## Audio Systems Guide for VIDEO AND FILM PRODUCTION

A low impedance mic – with an impedance of less than 600 ohms – can be used with cable lengths of 1,000 feet or more with no loss of sound quality. For this reason, professional microphones always have low impedance.

A microphone's *wiring configuration* affects the signal's tendency to pick up electrical noise or hum as it passes through the cable. A microphone can be configured with either a *balanced* or an *unbalanced* output.

A microphone is said to have a *balanced* output when its signal is carried on two conductors with a separate connection to the metallic shield inside the mic cable. The signal on each conductor is the same level but opposite polarity. When connected to a balanced input on a sound system or recorder, this configuration is very effective at rejecting electrical noise and hum, and is essential for longer cable runs.

An *unbalanced* microphone output carries its signal on just one conductor with a separate connection to the metallic shield inside the mic cable. An unbalanced connection is not very effective at resisting electrical noise and hum, so unbalanced microphones are typically used only with shorter cable runs.

However, most modern, professional microphones have balanced outputs, so as long as you are connecting to a device with balanced inputs, this is not an issue.

### Physical Design

In choosing a microphone for a specific application, the first thing that must be considered is the physical design. In other words, how it will be used?

- Will it be held by the person talking?
- Will it be clipped to the user's clothing, or attached to his/her person in some other manner?
- Will it be located a few feet away from the subject(s), so that it remains out of the frame?
- Will it be attached to a stationary object or positioned in front of one?
- Does it need to move to follow the action?

The answers to these questions will depend on the specific type of production you're working on. Important factors include action, context or setting, and the recording environment. If it's a cooking demonstration, the talent can't hold a microphone. If it's a TV commercial or a story set in the 1800's, the microphone should not be visible. If it's a demonstration of how to safely ride a skateboard, the mic will need to move to track the subject.

Different microphones are best suited to meet the above requirements.

**Handheld** – The most common kind of microphone for general use is the handheld type. While it can be held by the user, mounted on a floor or desk stand, or attached to a flexible “gooseneck” on a lectern, these options result in the mic being very visible, which is not practical in all video productions. A good quality handheld mic should have an internal shock-mount which will minimize handling noise (thumping sounds transmitted through the handle and picked up by the microphone cartridge), and it should be ruggedly constructed to withstand physical abuse. Models at the upper end of the price scale will usually offer clearer, wider-range sound, better shock mounting, and more durable construction.



SM58 Handheld  
Microphone

**Distance Tip when Using a Handheld Mic:** Whether held in the hand or mounted on a stand, the microphone should be positioned about 6”-12” from the talker’s mouth, pointing up at about a 45-degree angle. With unidirectional microphones, holding the microphone very close (3”-6”) will cause additional emphasis of the lower frequencies (known as proximity effect), resulting in a “warmer”, bass-heavy sound.

**Lavalier** – If you have only one microphone in your audio kit, it should be a lavalier type, which attaches to the user’s clothing but can also be laid on a podium or clipped to a mic stand in a pinch. Lavalier microphones leave the talker’s hands free to gesture or demonstrate a product, and because they are very small they tend to disappear on camera. Also, using a lavalier will keep the distance from the microphone to the talker’s mouth fairly constant, reducing the need for frequent adjustment once the levels have been set.

In situations where the microphone cannot be visible, it’s usually possible to conceal a lavalier mic under a shirt collar or even underneath a thin layer of clothing.



MX150 Lavalier Microphone

**Tips on Using Lavalier Mics:** For best results, lavalier mics should be placed on the outside of clothing, about six to eight inches below the chin. They are generally clipped to a pocket, lapel, or necktie. If none of these options are available, the mic can also be clipped to the collar of a shirt or blouse. Sound quality in this position may be somewhat muffled, however, because some high frequencies (which contain consonants) do not fully wrap around to the area under the chin.

**Tips for Concealing Lavalier Mics:** In some productions, it is necessary to hide the microphone. It is also important to prevent both the microphone and the first few inches of cable from rubbing against either the body or clothing, which will cause noise. Here are some options:

- Under the shirt collar. The mic is lightly taped to the inside of a dress shirt collar, near the opening in front. The cable can be routed around to the back of the neck, over the collar and under the shirt.
- On eyeglasses, on the inside of the temple. The cable is routed over the ear and down the back.
- On the forehead or cheek, secured with medical tape or gum. A disadvantage of this method is that the microphone is directly exposed to perspiration and makeup.
- On the chest, secured with double-sided tape to both the skin and the inside of the shirt. Try to avoid placing the mic behind any material having more than one layer. This reduces pickup of high frequencies, which results in a flat, “muddy” sound.
- Consider a magnetic mount instead of a clip mount (or have both in your kit), since a magnetic mount can be placed on clothing that does not have a convenient edge for a clip or in a place that is less conspicuous.

**Headworn** – In cases where freeing up the subject’s hands is more important than low (or no) microphone visibility, consider using a headworn microphone. Headworn microphones can be positioned closer to the talker’s mouth and maintain a consistent distance and sound quality when the talker moves his or her head. While headworn microphones are becoming ever more clandestine and are available in various skin tones (look for them in Broadway plays and musicals), they will still be visible on camera.



MX153 Headworn Microphone

**Surface Mount** – These microphones are designed to work on a flat or fixed surface. Surface mount mics are usually physically contoured to look less intrusive on a conference table or desktop. The microphone element is located very close to (but not touching) the surface, so that sound waves reflected from the surface arrive at the mic element at the same time as the direct sound. This effectively doubles the sensitivity of the microphone compared to a free-standing handheld type at the same distance. (This sensitivity boost assumes that the surface is sufficiently large to reflect even low-frequency sound waves.)



MX391 Surface Mount Microphone

**Tips on Using Surface Mount, Stand Mount and Gooseneck Mics:** If table vibrations are a problem, use a shock-mount or try putting a very thin piece of soft foam rubber underneath the mic. (A computer mouse pad with a hard top surface often works well.) Keep in mind that the sound quality of these types of microphones are often affected by the size of the surface on which they are placed. For best results, use a surface at least 3 feet square; using a smaller surface will tend to reduce pickup of low frequencies. The effect on speech frequencies is usually mild, and may actually improve intelligibility of very low voices by reducing boominess.

**Shotgun** – The shotgun microphone is so named because the long, slotted tube in front of the microphone cartridge makes it resemble a shotgun. This “interference tube” makes shotgun mics significantly less sensitive to sound coming from the side and rear than other directional microphones. A shotgun mic’s extremely directional pickup pattern (called a line/gradient pattern) makes these popular for news gathering, outdoor sports coverage and TV/film production.

Shotgun microphones are not telephoto lenses for sound or amplifiers. They do not allow you to zoom in on a conversation from 100 feet away. Here’s a much more accurate analogy: imagine looking through a long tube at a person standing 20 feet away. The person’s image does not appear to be any larger or closer, but is somewhat easier to see, because the eye is not distracted by things happening off to either side. This is exactly what shotgun mics do best: screen out sounds coming from the sides, making the sound coming from in front easier to hear.



VP89 Shotgun Microphone

## Audio Systems Guide for VIDEO AND FILM PRODUCTION

In practice, a shotgun microphone can typically be placed at four to five times the acceptable distance for a standard omnidirectional microphone. However, make sure to keep in mind that the shotgun mic will also pick up some sounds coming from behind the subject.

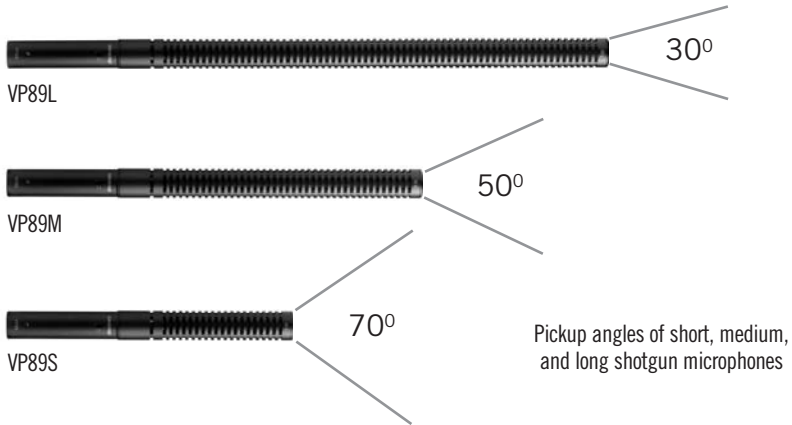

**Tips for Using Shotgun Mics:** Shotgun mics can be positioned slightly above, below, or to the side of the sound source, so that the mic does not appear in the camera frame. Try to avoid aiming the mic at a hard surface, such as a tile floor, brick wall, or hard ceiling. These surfaces reflect sound waves, and may reflect background noise into the microphone or cause the sound to be slightly hollow. A heavy blanket can be placed on a reflective surface to provide some temporary sound absorption. Shotgun mics are more sensitive to wind noise than standard microphones, so try to avoid moving the mic rapidly and use a foam windscreen if possible. Larger “zeppelin” or “blimp” type windscreens are usually necessary outdoors. Also, it’s a good idea to use a rubber-isolated shock mount to control handling noise that may be transmitted through a stand or boom.



VP89 With Rycote  
Windscreen Accessory Kit

### Camera-Mount Microphones

With the rising popularity of DSLR’s and compact video cameras, a new class of compact microphones specifically designed for camera mounting has emerged. These camera-mount microphones typically feature a supercardioid or hypercardioid pickup pattern, foam windscreen, integrated shock mount, accessory shoe adapter, and 3.5mm output plug. Some models can even record audio on an internal flash memory card. These microphones offer a lightweight and convenient all-in-one solution for capturing audio for video.



## PART TWO

# Wireless Systems

Wireless microphones are a great alternative to their wired counterparts in situations where the presence of a conventional mic cable puts constraints on the user's actions.

### **Wireless Components**

In essence, a wireless microphone is a miniature radio station. A microphone cartridge (which may be a dynamic or condenser type, see earlier) converts incoming sound waves to an audio signal. The signal is sent out by a low-power transmitter, and then picked up by a receiver located nearby, which converts the radio-frequency signal back into audio. The transmitter can be contained in the handle of the microphone, in a small pack designed to be worn on the body, or in a block or tube that can plug directly into any standard microphone with an XLR connector. The receiver can be a tabletop unit, a rack-mount unit, or a portable battery-operated type that can mount on top or in the camera. The combination of the *microphone*, *transmitter*, and *receiver* is known as a *wireless system*. A cable then connects the audio output of the receiver to the input of the camera or audio recorder.



FP125 VP68 Bodypack Handheld  
Combo System

*For those of you desiring a far more complete understanding of wireless microphone systems, please check out: Shure's Guide to Wireless Systems.*

**<http://www.shure.com/americas/support/publications/index.htm>**

### **Portable and Camera Mount Receivers:**

Portable battery-powered wireless receivers are available for use in situations where both the transmitter and the receiver must move around. These units are very small — usually about the size of a deck of cards — and can be worn on the body or mounted directly to a camera.

A short cable connects the audio output of the portable receiver to the audio input of the camera or recorder. Better models offer a separate headphone output, so that the camera operator can monitor the audio through headphones or an ear piece. (See “monitoring your sound—always a good idea” later.)



Shure FP5 Mounted on Camera

A wireless microphone system which includes a portable receiver is a very handy thing to have on a video shoot where both the subject and the camera may be moving. In larger productions that involve multiple talkers, multiple portable receivers can be connected to an audio recorder carried in a bag.

## Audio Systems Guide for VIDEO AND FILM PRODUCTION

Another application for a portable wireless receiver is to feed audio from a mixer to a camera located across the room. In a large meeting room, for example, the audio mixer is often located at one side of the stage, while the camera is at the back of the room. In such a scenario, an output from the mixer can be connected to the input of the wireless transmitter, and the portable receiver attached to the camera. This eliminates the need to rely on the camera's internal microphone or to place additional microphones specifically for video recording.

### ***Some Important Tips When Using Wireless Systems:***

- Make sure you have fresh batteries. Put them in right before the shoot and test them to make sure they work.
- Keep the distance from transmitter to receiver as short as possible.
- Always do a “walkaround” before the event begins; that is, listen to the system while walking around the anticipated performance area. If dropouts occur, try moving the receiver a few feet and repeat the walkaround. If possible, the walkaround should be done at the same time of day as the event, to expose nearby users of the frequencies on which you intend to operate.
- Make sure that the receiver's antenna has a clear line of sight to the transmitter.

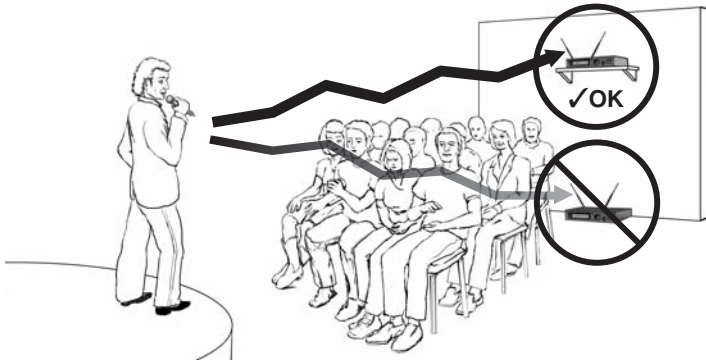

Proper and improper antenna and receiver placement

### ***Spectrum for Wireless Microphones***

Just like radio stations, wireless microphones operate on specific frequencies in sections of the frequency band, which in the U.S. are regulated by the Federal Communications Commission (FCC). These frequencies are measured in megahertz (abbreviated “MHz”), which describes the number of times that the signal oscillates in one second.

Selecting the right frequency is just as important as selecting the right wireless microphone system. Do not assume that the wireless system that works well in Peoria will work well in Portland. This is not because the system is any different, but because the frequencies available for use in Peoria are likely very different than those in Portland.

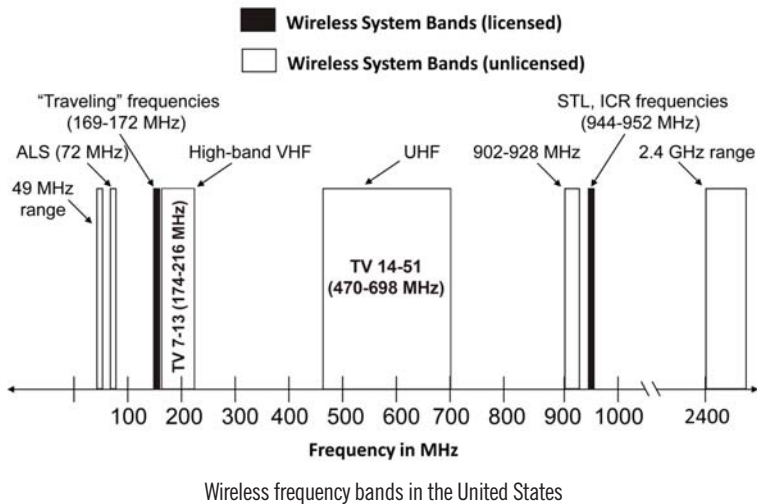

### Frequency Selection

One of the most vexing challenges for videographers who use wireless microphones is frequency selection. Virtually all wireless systems sold today are “frequency-agile”, meaning that the frequency can be adjusted by the user, making it easier to prevent interference and insure clear audio without dropouts. Here are the priorities when choosing which frequency to use:

If you’re using a wireless system that operates in the VHF or UHF TV bands, the frequency you choose must be on a TV channel that is not assigned to a TV station or public safety agency within 50-70 miles of your location.

The frequency must be different than those used by other wireless systems (wireless mics, in-ear monitors, intercom systems, etc.) at the same venue. The amount of separation between frequencies that is required depends on the performance of your system. A safe margin is about 1 MHz, unless you know that your system can tolerate closer spacing.

If there are 3 or more wireless systems in use at the venue, their frequencies must be mathematically “compatible” with each other. This is important because two wireless systems on different frequencies – even frequencies that are spaced widely apart – can interact with each other to interfere with a third system operating on its own frequency. The interference might be heard as a steady buzzing noise or as frequent signal dropouts. This condition (known as “intermodulation distortion”) gets worse when the transmitters get within a few feet of each other, so you might not notice it until all of your subjects take the stage. At an event where your wireless system will be used at the same time as the venue’s own systems, it is **ESSENTIAL** to verify what frequencies will be used to prevent interference.

Many wireless systems now include the ability to “scan” the spectrum and find a clear frequency. This feature should be used once the venue’s own transmitters are turned on, so that your system can avoid those frequencies.

***Navigating the New Wireless Landscape. (Worried about White Spaces?)***

Following the transition from analog to digital television (DTV), some sections of the frequency band formerly available for wireless microphone use were re-allocated for use by public safety agencies, and other sections were licensed to commercial wireless service providers. Wireless microphone use in the 698-806 MHz range — also known as the 700 MHz band — is no longer permitted.

Even after the DTV transition, some TV channels in each city remain unassigned to TV stations, and are still available for wireless microphone use. Many of these channels — often referred to as “white spaces” — will also be opened to other wireless devices (including commercial wireless devices as well as consumer smartphones, computers, and similar products). The FCC has designated two TV channels in each market that are reserved for wireless microphone operation, and are off-limits to commercial and consumer TV band devices. These channels vary in different locations, and can be verified by checking one of the geo-location databases that are being established. You simply enter your street address or latitude/longitude, and the database tells you which TV channels at that particular location are reserved for wireless mic use. Because TV station coverage patterns vary, the reserved TV channels may be different in different areas of the same city. If you work regularly at specific locations, it’s worth verifying which TV channels are reserved at each one. Two TV Bands Device Databases are in operation, allowing wireless microphone users to easily find out which two TV channels are reserved for wireless microphone operation at their location.

*For Whites Spaces updates, visit **shure.com** and search “White Spaces” in the search bar.*

Wireless microphone systems are permitted to operate in several different sections of the frequency band. By far the largest and most popular is **the UHF TV band**, which now covers 470-698 MHz. Wireless microphones may operate on any TV channel that is not assigned to a TV station in the local area, except for TV channel 37 which is reserved for radio astronomy and medical telemetry devices. Because assigned TV channels vary from city to city, the TV channels available for wireless microphone use vary also.

To provide operating flexibility, most wireless systems can be set to frequencies that span multiple TV channels. Entry-level systems might span two or three TV channels, while high-end systems often span 10 or more channels. Wider tuning range gives the video producer better ability to adapt to conditions at different locations.

In cases where open TV channels are very limited, it may be desirable to operate outside of the TV band. One option is the **900 MHz band**, which covers the 902-928 MHz range. This frequency range is only large enough to accommodate about 5 wireless systems, but that is sufficient for many video production needs. Other users of the 900 MHz band include consumer wireless devices and some commercial devices that monitor electrical usage and report data to the local utility company.

## PART THREE

---

# Audio Mixers, Interfaces and Recorders

## Connecting Microphones to Video Cameras and Recorders

The poor sound you often hear on online videos is often recorded on the camera's built-in microphone. The microphone itself is often poor quality, and it is (in most situations) positioned too far from the talker and too close to the camera's autofocus and image stabilization system. In addition, the audio circuitry in the camera may have too much hiss and not enough ability to manage varying signal levels for a professional sounding production. If you want better sounding audio, you will need to use an external microphone, and possibly an external audio interface or recorder.

### **Audio Interfaces**

An audio interface is a small box that acts as an intermediate stage between your microphone and your camera's audio input. Most interfaces have one or two balanced XLR microphone inputs (sometimes equipped with phantom power for condenser mics), and a means of adjusting the audio level. The output of the interface can be an unbalanced connection that works with a DSLR, or a USB connection that allows you to record directly to a computer.

An audio interface is handy because it gives you better control over audio levels and makes it easier to use professional microphones with XLR connectors.



DXA-SLR PRO

*Photo courtesy of Beachtek*

### **Audio Mixers**

If you're using several microphones at once (to record a meeting or panel discussion for example), it might be necessary to combine the microphone signals together before recording them. An audio mixer provides individual level adjustment for each microphone and a single output that includes the combined output of all the microphones. The drawback to using a mixer is that it makes it difficult to isolate the voice of one talker during editing.

### **Using An External Microphone**

Using an external microphone allows you to choose the right type of microphone for your subject and the situation. It also gives you the freedom to put the mic in the most favorable position for sound quality. The choice of microphone you can use with your camera is dictated by the external mic input on your camera. Some cameras have a balanced mic input with an XLR connector, while others (including DSLR's) have an unbalanced input with a miniplug.

While you can usually find a microphone adapter to enable you to connect the desired microphone to your camera, unfortunately, it's not always a matter of getting the male and female connections to match. Connecting a professional microphone to a camera without an XLR input connector is not always as simple as getting a cable with the right connectors on both ends.

## Audio Systems Guide for VIDEO AND FILM PRODUCTION

Cameras use a variety of microphone input connectors and wiring schemes. Unfortunately, there is not yet a ‘standard’ to which camera manufacturers must adhere, and the specifications provided with the camera often say little or nothing about the microphone input.

The miniplug microphone inputs on most cameras fall into one of three groups, however; the trick is knowing into which group your camera falls:

- Is the camera mono or stereo? If it is stereo, we assume that you wish to record the audio onto both the left and right channels.
- If it is mono, does the microphone input jack supply DC voltage (sometimes labeled “Mic Power” or “+3 vdc”) for the manufacturer’s own accessory microphone? This DC voltage is not the same as the phantom power used for professional condenser microphones. Microphones or wireless receivers that do not require this power must be connected in such a way as to be isolated from it. Professional condenser microphones requiring phantom power cannot be directly connected to a camera with a miniplug input; a separate audio interface box or phantom power supply is required.
- If the camera is stereo, are there separate mono input jacks for the left and right channels, or a single stereo input jack that feeds both channels? If there are separate mono jacks, do they supply DC power?

In short: It’s always a good idea to hunt through the camera’s specifications to ensure the built-in microphone port accommodates your microphones of choice. If not, an audio interface box may be available from the camera manufacturer or another company that has one or two balanced XLR mic inputs with the appropriate miniplug output cable for the camera. Some interfaces offer adjustable microphone levels and phantom power for condenser microphones.

### ***Recording Directly to your Computer***

In some situations – like recording a webinar or computer tutorial – it makes sense to record the audio and video directly onto your computer. There are two ways to get audio into most computers: through the soundcard or through the USB port.

When you connect a microphone directly to the soundcard audio input, the results are usually disappointing. First, computer soundcards are almost never equipped with the same connectors as professional microphones, and don’t offer phantom power needed by most condenser microphones. This means that you’ll need some assortment of adapter cables and possibly a phantom power supply to connect your professional microphone. Once you do that, you still may not be happy with the audio. Soundcards are often poorly shielded from the electrical noise caused by fans, hard drives, and processors inside the computer, which may add hum or buzz to your recording. Also, soundcards usually add noticeable hiss to the recording.

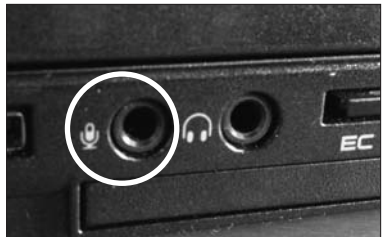

Analog Audio Input

A far better solution when recording audio on your computer is to use a microphone that connects directly to your computer's USB port, or to use an external USB interface. This is an external tube or box that goes between your microphone and your computer. The interface lets you connect one or more professional microphones to its XLR inputs, and often provides phantom power for condenser mics. Better interfaces have controls to adjust the microphone level being fed to the computer, which is really important if you want a robust, professional-sounding recording. It's also important for the interface to have a headphone output with its own volume control, so that you can monitor what's being recorded.

The best interfaces also let you monitor the sound being played back from the computer's recording software while you're recording, so that you can record yourself singing or playing along with a pre-recorded music track. Ideally, you should be able to adjust the headphone blend of the audio being recorded versus the audio being played back.



PG42USB  
Microphone

X2U XLR-USB  
Adapter

### ***Using An External Audio Recorder***

You may find that recording audio directly to your camera is unsatisfactory, due to excessive hiss, distortion, or lack of control over audio levels. In this case, video producers use a “dual system” in which the video is recorded on the camera, and the audio is recorded on an external audio recorder.

Using an external audio recorder gives you much better control over audio levels and less hiss than most cameras. Plus, a good audio recorder usually has balanced microphone inputs with XLR connectors, and often phantom power for condenser microphones. For larger productions, recorders with four or eight tracks are available, allowing each talker's microphone to be recorded separately to enable more precise control of signal levels and easier editing.

One important concern is how to synchronize the audio on the recorder with the video on the camera. The solution is to begin every shot with a hand clap that is picked up by the microphone and seen by the camera. During editing, the audio track can be moved forward or backward so that the sound of the clap matches the visual.

The audio recorder allows you to precisely adjust for signals of different levels from multiple sources and preserve them as separate audio tracks that can be edited into the program as appropriate. Some recorders have a variety of input connectors, designed to accommodate signals of different types and levels. A popular audio recorder is shown in the accompanying photo.



Roland® R-26  
6-Channel Portable Recorder  
*Photo courtesy of Roland*

### ***Mic And Line – What Do They Mean?***

Some recorders have switches for setting each input jack for mic level or line level. These refer to the signal level or intensity that the input is designed to accept.

A mic-level or microphone-level signal is the amount of voltage that comes out of a microphone when someone speaks into it — just a few ten-thousandths of a volt. (Of course, this voltage varies somewhat in response to changes in speaking volume and source-to-mic distance.) A line-level signal is approximately one volt, or about 10,000 times as strong as a mic-level signal, so the two do not ordinarily use the same input. Connecting a microphone to a line-level input will result in almost no sound at all, because the signal is so faint that the line input cannot hear it. Connecting a line-level source (such as a CD player) to a mic-level input will cause the sound to be loud and distorted because the line signal is much stronger than what the mic input will accept. Inputs and outputs on better mixers and recorders are switchable for either mic or line level operation.

### ***Other Recorder Features***

Some recorders have low-cut filter switches for each input. These may be labeled “In” and “Out” rather than “On” and “Off”, a custom resulting from the fact that some additional circuitry is being placed “in” the signal path. Moving these switches to the “In” or “On” position filters out some of the low frequencies from the signals on those channels. This feature comes in handy for reducing the rumbling noises which often come from air conditioning, wind noise, etc. A limiter feature is extremely useful, and it will not hurt to leave it on all the time. A limiter acts as a ceiling for the audio signal, and tries to keep it below the point at which distortion occurs. Some limiters can be adjusted to activate at different levels, called the threshold.

#### ***Dealing With Automatic Gain Control***

Most consumer-grade cameras and some professional models have an Automatic Gain Control (AGC), which adjusts the audio level up or down as necessary. The AGC circuit boosts audio level to compensate for lower sound levels (since the built-in microphone is often far away from the sound source) and decreases level to offset louder sounds. Unfortunately, many AGC circuits tend to vary the sound level inconsistently, resulting in sound described as “pumping”, “breathing”, or “whooshing”.

If you are using an external microphone, which will almost always result in better audio, you should turn off the AGC.



## Cables and Connectors



Cables and connectors are probably the most overlooked link in the audio chain, and yet poor quality cables and/or faulty connectors are frequently the cause of major audio problems.

There are basically two kinds of connections used between audio devices: *balanced* and *unbalanced*. A balanced connection requires a cable with two wires (one for the “hot” signal and one for the “return”) enclosed by a shield of metal foil, braid, or mesh. The shield intercepts the random electrical signals that bombard the cable from various sources and drains them to ground. Together, the wires and the shield keep the audio signal free of interference.

**Cable tip:** For applications in which cables will be frequently disconnected and coiled up for storage, choose those which use braid or mesh shielding; these are more resistant than metal foil to cracks or tears due to flexing, which can cause electrical shorts.

An unbalanced connection utilizes a cable with a single wire surrounded by a shield, but in this case the shield has to do double-duty. It carries the “return” portion of the audio signal as well as protecting the wire inside from electrical interference. This method is not nearly as effective as the balanced type, so unbalanced audio cables are easily affected by florescent light fixtures, some types of dimmer switches, and other audio or electrical cables that may be nearby.

As a rule, balanced connections will offer much cleaner, noise-free performance.

Today, the most popular connectors for professional microphones and audio equipment are the XLR and USB connectors.

**XLR** – Male XLR connectors have three pins, and are used for signal output; female XLR connectors have three sockets, and are used for signal input. The XLR connector is very rugged, rarely bends or breaks off while connected, and most versions lock together securely so that accidental unplugging is unlikely. A cable that has an XLR connector at both ends almost certainly indicates a balanced connection. XLR connectors are found on both low- and high-impedance microphones. High quality and professional microphones tend to favor the XLR connector over the 1/4-inch phone plug (See later.)

**USB** – Universal Serial Bus (USB) connectors and cables, which have become ubiquitous with computer peripherals are unsurprisingly becoming more common for microphones, since more audio and video recording is taking place directly on PCs. This has created the need for XLR-to-USB adapters, which let you use your XLR cables and XLR microphones with devices that have USB ports.

**1/4-inch phone plug** – Another somewhat common audio connector is the male 1/4-inch phone plug, which mates with the female 1/4-inch phone jack. The name originates from use of this connector on early telephone switchboards. These can be found on cables used with almost any type of audio equipment: headphones, loudspeakers, amplifiers, signal processing gear, and microphones. Generally speaking, 1/4-inch phone plugs are used on lower-end microphones. Two-conductor types (sometimes called “TS” or “tip-sleeve”, which refers to the area of the connector used for each wire) have two distinct segments and are used for unbalanced mono connections. Three-conductor types (sometimes called “TRS” or “tip-ring-sleeve”) can be configured to carry a balanced mono signal or an unbalanced stereo signal. Microphones and microphone inputs on mixers using 1/4-inch phone connectors are almost always of the unbalanced high-impedance type.

**Miniplug** – Miniplugs come in two sizes: 3.5 millimeter (1/8 inch) and 2.5 millimeter. The 3.5 millimeter version is the same miniplug commonly found on headphones and earbuds. While notoriously fragile for microphone applications, due to their small size, miniplug connectors are frequently used on consumer and even semi-professional video equipment, including DSLR cameras. They almost always indicate an unbalanced stereo audio connection. Most microphones that come equipped with miniplugs are low-cost units. If your equipment only has a miniplug port or 1/4-inch microphone input, you can still use a good quality professional mic. You just need to obtain a cable with the appropriate connectors, or in some cases, an impedance transformer.

**RCA plug** – The last type of connector you’ll likely run into is the male RCA plug or phono plug, which mates with the female phono jack. The name “phono” comes from the fact that these are the standard for connecting phonograph turntables (as well as tape decks, CD players, and so on) to home stereo equipment. Phono plugs are really not designed to be inserted and removed over and over again, as doing so will eventually result in a broken or intermittent electrical connection. At that point, the usual procedure is to throw the cable away and buy a new one; the problem is that you never know when it’s going to happen.

***Microphone cable tips:***

- 1) If you are upgrading your audio equipment and are thinking about buying higher-quality microphones, you should invest in some heavy-duty microphone cables with XLR connectors. If you are using a USB input port or USB microphone, the same advice applies, but also invest in an XLR-to-USB Signal Adapter.
- 2) If your equipment uses 1/4-inch, miniplug or RCA connectors, buy professional quality cables with metal connectors that can be disassembled for service rather than molded-on plastic connectors. If you do have a problem with a connection, you can repair it rather than replace the entire cable. It is a good idea to carry one spare cable of each type that you use, so that you can change a suspect cable quickly when a problem arises.

## PART FOUR

---

# Common Applications

## General Guidelines

Following are some hints on choosing the right mics for some common audio/video applications. In most situations, there is no single “right” way, but some ways are often better than others and there are some common best practices so you capture the audio you want – especially if you only get one chance.

In some cases, you may decide to sacrifice sound quality to gain another benefit, such as concealing recording equipment, accommodating your subject’s refusal to use a certain type of microphone, or for budget constraints.

***In all cases, there are a few General Ground Rules that always apply:***

- 1. Place microphones as close as is practical to the sound source.** Each time the *source-to-mic* distance increases by a factor of two, the sound pressure level (SPL) reaching the mic decreases by a factor of four, making clear sound pickup progressively more difficult. This is called the *inverse-square rule*, and it applies whether the distance increases from 6 inches to 12 inches or from 6 feet to 12 feet. This means that the talker-to-mic distance must be cut in half to cause a significant improvement in sound quality.
- 2. Use the fewest microphones necessary for the situation.** People tend to “over-mike” shots, that is, using three or four microphones when one or two would be sufficient. Excess mics mean more background noise pickup, a greater chance of a “tin can” sound (caused by sound reaching more than one open microphone), and more levels for the operator to keep in mind. When additional mics don’t improve sound quality, they will probably decrease it. In short: start simple with the fewest mics possible and then add mics as needed.
- 3. Set levels every time you change your setup.** To get a good recording, you need to be sure that the audio level is not too low and not too high. Set the level to accommodate the loudest expected volume, since you can’t adjust it during a take. Also be aware that talkers often speak louder while presenting than they do when saying “check 1-2-3” during setup. Some audio recorders can record a duplicate “safety” track at a reduced level, to guard against unexpectedly loud levels. A tone generator can be useful for setting consistent audio levels at different devices in the audio chain (e.g. wireless receiver, mixer, audio recorder, camera). The tone generator can be an external device or can be built into a wireless receiver or audio recorder.
- 4. Consider double-miking or using a back up recorder** – In a live event, even a remote chance that the microphone might fail constitutes an intolerable risk. For this reason, a news anchor or key presenter may wear two lavalier microphones for redundancy. Only one mic is used at a time; if the primary mic fails, the backup mic channel can be turned up immediately. Double-miking with lavalier microphones is usually achieved with a special tie clip or bar that holds two microphones.

**Note:** When wireless microphones are used, each lavalier mic must be connected to its own body-pack transmitter. These two transmitters must be on different operating frequencies, and their signals must be picked up by two different receivers.

Another option is to use a lavalier on the subject and a shotgun microphone as the backup. This helps capture clean sound in case the subject touches the lavalier or it picks up clothing noise, and also picks up more of the ambient sound.

A third option is a small digital recorder placed hidden near the needed sound, whether this is behind an object or in the pocket of the presenter or a bystander (e.g. the best man or pastor during a wedding).

- 5. Monitoring your sound is ALWAYS a good idea.** The question should not be *if* you monitor your sound during the shoot, but *how*. Just as bad as missing the shot is failing to capture the sound or realizing that the key portions of the audio are too low, include a mechanical hum, are marred by wind noise, or etc. Many of these cannot be fixed in “post” and even if they can be somewhat corrected, that takes time and lessens the overall quality.

Also, what you hear when you listen live – from your vantage point – is not the same as what your camera or other equipment hears. The human ear is an amazing instrument. Never assume your audio equipment can do as good of a job of eliminating distracting sounds. It is quite common for a microphone to pick up sounds that are not noticeable to the human listener in the same environment.

Additionally, there might be a sound that’s being captured by the microphone near the action that’s not loud enough to be heard from where you and others are standing.

The easiest way to monitor your sound is to use the headphone jack on your recorder or other equipment.

Most cameras, however, do not have a headphone output. If you are not using an external microphone being fed into a recording device with headphone jack (hint: try hard to use an equipment set up which allows monitoring) you can either test the audio before, and hope nothing crops up during the live shoot, or you can use a digital recorder and monitor that audio. This ensures your backup audio is clear, at least.

**Monitoring Tip:** Try to monitor the sound as close to the end of the audio signal path as possible. A faulty cable or connector could be your nemesis and you will never know it unless you are monitoring the same sound as is being captured.

- 6. Storyboard the entire shoot. Pre-test the audio for each section – at the same time of day.** We all have the image of the director in mind framing upcoming shots using his or her thumbs and index fingers. This is all well and good, but you cannot frame good audio in the same way, so it’s best to make a list of shots and setups you will need and how you plan to capture the sound for each setup.

Some good questions to ask (and answer) for the audio capture portion of each setup, include:

- Can the mics be in the frame (whether in view or hidden) or outside of it? If the mic must be outside the frame, how close can you get to the sound source?
- Who will be using the microphone and how can you make this as easy as possible for them?
- Who might grab the microphone for an impromptu speech?
- What environmental sounds or concerns are present, e.g. wind, air conditioning and heating systems, flat surfaces (that might cause sound to reflect), noisy floors or squeaky chairs? Could rain or other weather affect the sound (e.g. rain hitting a metal roof or glass skylights)?
- Are there any ambient sounds you want to capture (e.g. audience, factory), at what levels and when?
- How much movement will there be and will this affect sound capture?
- Can you place a digital recorder near to the sound source (examples: in the best man's jacket pocket or behind the podium) as a back up?

It is also a great idea to test your sound capture at the same time of day, not simply in the same locations. Environmental noises (e.g. traffic, airplanes overhead, etc.), wireless frequency interference and other issues might differ depending on time of day.

Often you cannot control location, but when you can, please remember that sound is at least as important as video (in many applications sound is the far more important half) and it's not always a good idea to sacrifice the former for the latter.

Also remember that most audio issues can be predicted and avoided by carefully assessing the environment and considering what may (and probably will) go wrong.

## Common Applications and Audio Suggestions:

**Self-Interview (e.g. Video Blog or Vlog):** Generally the presenter is also the videographer and has placed the video camera in a fixed position facing himself or herself. Relying on the video camera's microphone for self-interviews is often the least expensive and easiest solution, but it also often results in poor sound quality if the room is noisy or reverberant. (See ground rule #1 on page 27.)

### *There are many options for miking self-interviews, including:*

- handheld cardioid mic or a lavalier, both of which, however, will be visible in the shot.
- a shotgun mic on a boom positioned just out of frame. This increases the source-to-mic distance, but hides the microphone from viewers. Another advantage is that it keeps the mic facing the presenter if he or she repositions the camera to show something else in the area.
- a shotgun mic on the video camera itself, which keeps the mic facing the presenter if he or she is moving around and holding the video camera at arm's length or repositioning via a video camera arm or other method.

## Audio Systems Guide for VIDEO AND FILM PRODUCTION

**Interview:** In this situation, a company officer or other presenter is speaking directly to the camera. If this takes place in a studio or quiet office, the best mic to use would be a lavalier, since the speaker's hands would be free to gesture and you would eliminate the possibility of a handheld mic being positioned incorrectly or, worse yet, moved around. The unobtrusiveness of a lavalier mic also tends to put the talker more at ease, resulting in a more natural look and sound.

If the shot takes place outdoors or in a noisy factory, you may need a unidirectional mic to cut down the background noise. You could...

- 1) use a unidirectional lavalier mic,
- 2) have the speaker hold a handheld unidirectional mic (or put one on a stand in front of him), or
- 3) use a shotgun mic on a boom, positioned so that it does not appear in the video frame. If the boom is held by an operator, this method also permits the talker to move around without getting tangled in a microphone cable.

**Note:** If the interviewee is seated... the same setup applies here as for the standing interview style with one consideration: chairs tend to squeak.

Seated interview subjects often shift around when they are moving and the microphone can easily pick up this noise, especially when the microphone is some distance from the speaker's mouth. If you can't switch chairs, place the microphone as close to the sound source (the speaker's mouth) as possible and use a unidirectional mic to cut down on ambient (chair) noise. If you use a shotgun mic on a boom, place the mic below or to the side of the talker so that it is aimed away from the chair.

### ***Using wireless in-ear monitors for interviewers and presenters***

The wireless in-ear monitor system is becoming a common method of ensuring interviewers get the input they need and the presenters stay on script.

An in-ear monitor system is a wireless system specifically designed to feed audio to the talent's ears, rather than to a camera or recorder. The desired audio signal is connected to a stationary transmitter, which broadcasts the signal to any number of body-pack receivers worn by talent or crew members. The receiver feeds small earpieces that are nearly invisible on camera.

Better systems offer the option of transmitting either stereo audio or two simultaneous mono channels, which the listener can blend and adjust to their preference.

Wireless in-ear or "personal" monitors can be used in a variety of ways in the broadcast or video production environment. Reporters in the field can hear questions



and answers from the broadcast studio; the narrator of a video program can listen to a prerecorded script while simultaneously reciting it (sometimes called an “ear prompter”); an actor can hear stereo music playback or other pre-scripted sound to remain on cue; a presenter can hear questions picked up by audience microphones.

In many applications, the director can cut in to give instructions; in that case, the monitor signal is then called Interruptible Foldback, or IFB.

**Product or Process Demonstration; Training Video:** This time our speaker is demonstrating a product, usage of a machine or tool, or how to accomplish a specific task. Before you decide what type of microphone to use, consider the following:

- Does the product make any sound at all when demonstrated?
- If so, how loud is it?
- Do you want the sound to be part of the demonstration?

If the product makes little or no noise (like a personal computer, for instance), your best bet is probably to put a lavalier mic on the speaker’s clothing in a spot where it will not be disturbed by his or her movements.

If the product is very loud, such as a food processor or grinding machine, though, a good bet is to use a lavalier or a shotgun to pick up the first part of the demo (before the product is turned on), and then record the rest of the demo without any narration — just the sound of the unit working. Have the speaker do a voice-over without the machine on, which you can mix in during editing. Otherwise, you’ll have to use a shotgun mic positioned no more than a foot or two away from the speaker’s mouth and perpendicular to the device for minimal noise pickup. If the product is very small and you have to pick up its sound (such as that of a digital watch alarm beeping), you may need to use a second mic positioned close to it, or else a shotgun a few inches away from it.

For all product, process and training videos or films, it’s best to record it a few times:

- The full demo, with the presenter speaking and the machine running
- Same demo without the presenter speaking
- Same demo without the machine running this time
- Voice over of entire demo or sections, if needed

**Panel Discussion:** Here, your assignment is to film a panel discussion before a live audience. Let’s say that there are five people on the panel, and you also wish to pick up the questions and comments of the audience. You will be operating the camera yourself, so all the microphones will be on at all times to ensure that no comments are missed. How many mics you use on the panel depends largely on how closely together they are seated. You may be able to pair people up and use one microphone for each pair. Keep in mind that microphone positioning has a significant effect on sound quality, however.

## Audio Systems Guide for VIDEO AND FILM PRODUCTION

The rule for this situation is widely known among professional audio engineers, and you would do well to memorize it:

***The 3-to-1 Rule — The distance between open microphones should be at least three times the distance from each microphone to the nearest talker.***

For example, if you place a microphone one foot in front of each talker, the mics should be at least three feet apart from each other. Placing the mics closer together will result in a hollow, “tin can” sound, caused by the same sound reaching more than one microphone at slightly different times. If it’s convenient to have panel members positioned in pairs as mentioned above, you’ll probably wind up with sufficient separation between mics.

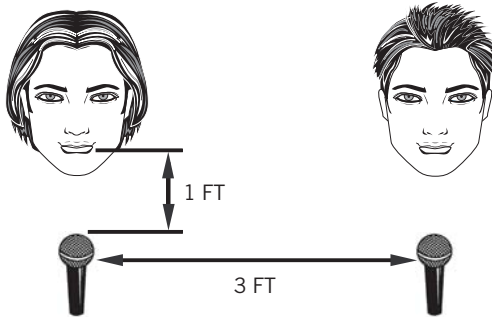

The 3 to 1 Rule: The distance between microphones should be at least three times the distance from each microphone to its intended sound source.

To minimize pickup or room noise and reverberation, it’s best to turn off microphones that are not being addressed. This could be done either by a live operator or with a voice-activated mixer.



***Handling Q&A sessions or audience questions during a panel discussion or live event***

Picking up audience questions is a perennial problem for audio people, primarily because there is no truly effective way to do it. For audience questions and comments to be intelligible, you have two choices:

- 1) bring the audience member to a microphone, often by placing a unidirectional microphone on a stand in the aisle; or
- 2) bring a microphone to the audience member. Assigning a person (or persons) the task of walking around the room with a wireless mic and going to each person who has a question.

You might be thinking: What about about pointing a shotgun mic at each audience member to pick up his or her questions? This usually doesn't work very well if the questions must also be fed to the PA system in the room (because of feedback), but it can work if the audio is only for the video if the room is not too noisy. Shotgun mics are not very effective beyond 20 feet in a large crowded room. And if people in front of them are (rudely) talking, you will pick up those sounds.

**Conference Table:** Your main goal in this situation is to capture a meeting of eight people seated around a rectangular conference table. This is similar to the panel discussion above, but without the audience or audience questions, which makes it far easier.

The often-considered solution of putting a lavalier microphone on each person may not be the best here. The ideal approach is to individually mic each participant and record each microphone's output separately on a multi-track recorder. During editing, you can select only the audio track of the person speaking at that moment. If all eight microphones are mixed together and recorded, you will probably pick up too much room noise and reverberation, because only one mic is picking up the talker's voice but all of them are picking up the room noise.

If recording individual tracks is not an option, having an operator bring each mic up and down as needed might work if the nature of the program is scripted enough that he or she will know who will talk next, since the flow of conversation might move too fast for the operator to keep up.

If you are thinking about having the talkers turn their own mics on and off as they speak, then you haven't done this type of shot before. They will forget to turn them on when they want to speak and/or forget to turn them off after they are done.

Your best bet here is to use two omnidirectional surface mount microphones, located so that one mic is centered on each half of the table. Each person should be approximately the same distance from the nearest microphone. Otherwise, levels will be inconsistent and some speakers will not be picked up as well as others.

## Audio Systems Guide for VIDEO AND FILM PRODUCTION

If an audio person is available, he or she could also use a shotgun mic on a boom, although this method would make it difficult to pick up more than one person at a time or to keep up with a lively conversation.

As we mentioned previously, stand-mounted mics in front of all participants (or one between every two people) and a voice-activated mixer would be an excellent alternative.

**Voiceover:** Since appearance isn't a concern in this situation, you can position the mic directly in front of the talent's mouth. The best bet is to use a stand (versus a handheld mic) to keep the mic position fixed and eliminate any handling noise. Find a room that is free from ambient noise, and with minimal reverberation caused by hard surfaces. If a recording studio is not available, a closet filled with clothes can work well.

If you are looking to capture ambient sound, you can either ...

- 1) Record the presenter within the environment using an omnidirectional mic; or
- 2) Mic the environment separately and then mix it in at the desired level. This second option makes more sense since you can later mix the environmental sounds at a natural and noticeable level, but does not make it hard for listeners to clearly hear the presenter.

Almost any type of microphone can be used for voiceovers, but a high-quality studio type microphone is often the first choice. A studio mic will deliver a fuller, more authoritative sound that is usually desired for voiceovers. The choice of condenser vs. dynamic depends on which mic style matches the announcer's voice.

Position the mic about 6-8" away from the mouth. (No ruler handy? 6-8" is approximately the distance from the tip of your thumb to the tip of your pinky when your hand is fully extended.) If the sound is overly nasal, raise or lower the mic. If you keep hearing popping sounds from plosives (e.g. t's and p's), try a pop filter or move the mic slightly off to one side.

**Podium-Style Presentation:** The common strategy here is to use condenser gooseneck podium mic, also called a lectern mic. The downside is that the presenter is now stuck behind the podium.

Providing a wireless handheld mic allows the presenter to walk around, but ties up one of his or her hands. Placing the mic on a small stand on the lectern allows the presenter to remove the mic when she or he moves around the room and then reattach it when standing behind the podium. This is often not a good idea, however, since there is a great deal of handling noise involved in reattaching the mic and, very likely, your presenter is not experienced at attaching or detaching mics from stands.

Best bet here is to use a wireless lavalier. It's unobtrusive, allows the presenter the free use of both hands, and goes where the presenter goes. If the presenter is comfortable with a headset mic, this choice might be an even better option.

**On-Stage Event:** There are as many solutions here as there are performance types. You might be recording a stage play, a choir performance, a graduation ceremony, a live competition, a dance recital, a worship ceremony ... the list goes on and on. Each of these events requires a unique approach to recording; however, there are a few good starting points:

- Mic the key presenters (especially those providing exposition) using a wireless unidirectional lavalier, handheld or headset style mic. This will help you capture these key performers (e.g. the emcee) on their own channel, regardless of what else might be happening on the stage.
- Use overhead mics or two condenser mics to capture a choir or musical ensemble.
- Mixing overhead mics for those with fewer speaking lines and lavaliers for key presenters will create a huge challenge during edit, since the sound from the lavaliers will be far better than the sound from the overhead/stereo mics. Best to have a few extra mics for anyone with smaller speaking roles.

A good rule of thumb for miking live performances: It's always best to give everyone with a speaking role their own wireless microphone.

- Mic the band separately. Odds are the band will have their own sound engineer. Communicating with this professional prior will save you a lot of time and grief. You can either plug into the house mixing console (ask first!) with a cable or a plug-on wireless transmitter, or put a mic in front of a loudspeaker assuming it's a full mix of the band. The latter option is sometimes the easiest and surest way to get the sound you need.

**Tip for miking the band:** Take a direct feed whenever you can. Use a plug-on wireless transmitter to send the feed from the band's mixing console to a portable receiver mounted on a camera.

- Don't forget to capture the crowd noise. The best way to do this is to position microphones on the far edges of the stage, raised above the audience and facing towards the back center. Condenser microphones work best here and, if you can, use two microphones to capture the audience in stereo. Recording these on their own channels will allow you to mix them in at a level appropriate for people viewing the film.

**Tip for capturing audience sound:** Position the microphones above the audience to capture more than the front couple of rows.

**Note:** If all you have is one camera and one mic, it's best to “get the mic off the camera,” since the mic will capture the people around you not the people on the stage. Mount the mic on a stand facing the performance (See “Directionality” for the best mic for this situation) or use boundary mics.

***Looking for more microphone techniques and guides?***

Shure has a complete set of educational booklets and FAQs designed to help amateurs and professionals alike find the techniques and solutions that best fit their requirement and budget.

Visit the “How To” section at **Shure.com** to find the answers and ideas you need.

**The Wedding:** Complexity level: high. Stress level: *maxed*.

For this application it is important to keep any technology out of sight (at least for the resulting video) and to understand that few, if any, participants are experienced at [(or focused on) using microphones.

While there is no one-size-fits-all solution to the many wedding venue types, here are a few starting points for your planning:

- Record the rehearsal. Not only will this be a good keepsake, but also you will be able to fine-tune the sound recording for the real event.
- Placing a lavalier on the official or a gooseneck mic on the lectern is a good starting point, however, this will *not* always capture the bride and groom as well as you might want. The larger the venue and the more ambient noise, the less likely this will work well. Some professionals advise lavaliers on both the official and the groom, since placing one on the bride is often not possible. Again, however, this might make the bride harder to hear than the groom and the lavalier might be visible in the wedding pictures, which many couples do not like.
- Giving the official a handheld mic, which he or she can hold in front of the bride and groom, works well, but this makes the microphone very conspicuous and relies on the official remembering to move the mic into place. Consider using a shotgun mic on the video camera or on floor, or two unidirectional microphones (hidden in the flowers or covered with tulle) pointed to the spot where the vows will take place.
- Mic the groom. **Tip:** Place a lavalier behind the groom's boutonniere (after the flowers are already in place and then dress the cable inside the coat).
- If the wedding is outside, be sure to use windscreens on all microphones to prevent wind noise.
- Consider double-miking or using a back-up recorder as fail-safe. (There are no 'do-overs' for weddings!)
- Position a microphone on a stand and/or use a wireless mic for any prepared speeches or toasts.

**Note:** Often the band leader or DJ will introduce the bridal party as they enter the reception. Also, sometimes people grab the band's mic to make a toast. Make sure you can capture that as well. In short: if there are other people's mics at the event, you can expect that one of these mics will be used instead of yours for something important. If you see a mic that's not yours, have a plan for when it is used for something that should have happened with your mic.

**Tip for miking loudspeakers:** You can have the mic pointed towards the loudspeaker from a few feet away. No need to place it right up against the loudspeaker; in fact, it's better if you don't.

- Don't forget the audience! Make sure to have microphones capturing ambient sound during the ceremony as well as the reception.

**The Webinar:** Most webinar applications include a 'record' option, which will record all audio and video components – as well as other speakers, such as the host and live questions or comments from attendees.

However, most people rely on their telephone handsets (sometimes cellphones) or computer headsets when speaking, meaning the sound input might not be very good. For the main presenter and host, it's better to use a headset or unidirectional microphone in a desktop stand. The audio from these mics can be used when the program is edited. Since no one is video recording the presenters or host, your concern is clarity, not having inconspicuous mics.

**Note:** Since the presenter(s) and host are often seated, ensure their chairs are not squeaky and that they know too much movement affects the sound, both for you and the live audience. In short: no rolling chairs and sit still!

**Factory or office walkthrough.** There are two challenges here. One is to record the primary speaker (the company CEO, for example) and the interviewer or secondary speaker if there is one. The other is to capture or avoid the sound of other people or equipment that may be encountered along the way.

If the talkers aren't moving more than a few feet, a shotgun mic on a fishpole or mounted on top of the camera may work fine. If the subject is moving farther, the interviewer can hold an omnidirectional handheld mic attached to a plug-on wireless transmitter, similar to those used by TV news reporters in the field.

If a cleaner look is desired, a wireless lavalier is the best solution. In many cases the lavalier mic on the primary talker will sufficiently capture brief questions from an interviewer, but extended conversation between two people will require two wireless lavaliers and two receivers. In this situation an audio assistant – who can monitor sound quality on both channels and alert you when a re-take is necessary – is extremely valuable.

**Tip for factory or office walkthrough:** Arrange for a site visit first, prior to the video shoot! This will give you a heads up as to any potential acoustic issues or obstacles you may encounter, such as restricted areas, noisy/high-traffic hallways, filming through windows, etc.

**Live sporting event.** This booklet is not designed for the professional film or television producer, so by “live sporting event”, we are discussing events such as high school football games, youth soccer games, and cheerleading competitions. Like the wedding and the live music event, there are as many ways to film and record one of these as there are events, but, again, there are some common considerations.

Often, home recorded videos do a good job of covering the players on the field, since the camera has a decent zoom function, but capture only the sound of the nearest spectators, since the camera’s built-in mic is a low-quality omnidirectional style that captures a circle of sound around the camera itself.

- The camera is often far from the sound source, meaning you need a shotgun mic to capture sounds that could be 10-50 yards away. Here is another case when you want to “get the mic off the camera,” such as mounting a shotgun mic to a fence or railing facing the players.
- If you have more than one microphone, make sure to have microphones pointed to the audience to pick up the audience reactions. Here, again, if you record the audience on a separate channel, you can mix the levels appropriately afterwards.
- If there is an announcer, tap into the sound system (i.e. the feed from the announcer’s box), provide your own stand-mounted microphone to the announcer or, failing those, mic the stadium loudspeaker.
- Place windscreens on all microphones used outdoors.

## PART FIVE

---

### Troubleshooting

No matter how well you plan ahead, sooner or later you will probably run into an audio-related problem. To help you out in those situations, we've listed some of the more common problems encountered in doing audio-for-video, along with some possible solutions.

**Buzz, hum, crackle, and other noises** – These are almost always caused by an electrical problem somewhere in the system. A low, steady buzz or intermittent crackle usually indicates a loose ground wire, probably in or near a connector. A humming sound is usually picked up by unbalanced cables near light fixtures, dimmer switches, or power or loudspeaker cables. You can try moving the mic cable around a bit, but the only permanent solution is to use balanced microphone cables. If the input on your camera or recorder is unbalanced, you can reduce noise susceptibility by using a transformer near the camera or recorder so that most of the cable run is balanced and shielded.

**Distortion** – This “fuzziness” or general lack of clarity results when the input of some piece of equipment in your audio chain is being overloaded (a condition called “clipping”). Once the signal is distorted, there is absolutely no way to remove the distortion with another device further down the audio chain. If the signal level coming from the microphone is too high for the camera or recorder and sounds distorted, for example, you must turn down that channel's input level control on the camera or recorder. In very loud situations, the range of adjustment might not be wide enough; you can use an attenuator (also called a pad), which reduces the level of the signal by a specified amount without altering its sound. The amount of attenuation is measured in decibels, or “dB” for short. A 10 dB or 20 dB attenuator is frequently all that is required to make a signal easier for the mixer to deal with; a 50 dB attenuator will bring a line-level signal all the way down to mic level.

**“Tin can” or “inside a barrel” sound** – This usually results when the microphone is located too far from the talker. The more reverberant the room is, the closer the microphone must be in order to obtain good sound quality.

“Tin can” sound can also be caused by phase cancellation, which occurs when the same sound waves reach more than one microphone at slightly different times. When the signals are combined in the mixer or during editing, the time delay between them causes unpredictable changes to the signal, resulting in a strange sound. The easiest way to avoid this problem is to observe the 3-to-1 rule or turn down unneeded microphones.

**“Popping” and wind noise** – Popping is caused by an explosive sound wave striking the microphone diaphragm, such as that which occurs when a talker says words beginning with the letters “p” or “t”. To lessen the likelihood of this phenomenon occurring, you should:

## Audio Systems Guide for VIDEO AND FILM PRODUCTION

- 1) keep the microphone at least 6 inches away from the talker's mouth, tilted toward the user at about 45 degrees from vertical, and
- 2) use a foam windscreen if the microphone's built-in pop filter is insufficient or if a very close source-to-mic distance is required. Wind noise is frequently a problem outdoors, especially with condenser microphones. The only solution is to use a foam windscreen, and in extreme conditions, a "zeppelin" or "blimp" type windscreen such as those used on shotgun microphones.

**Vibration noise, also called "podium thumping"** – This is usually heard in the form of low "thumping" when someone taps or bangs on the stand or lectern on which the microphone is mounted. It can be reduced (although not always eliminated) through the use of a shock mount. This is a special mounting bracket for the microphone, which uses rubber or elastic to isolate the microphone body from mechanical noise. An external shock mount may be essential if the microphone has little or no internal shock mount of its own.

**Feedback** – If you are using microphones to feed a loudspeaker system in the same room, you may occasionally encounter feedback (a loud howl or squeal when microphones are moved too close to the loudspeakers.) Feedback is usually caused by a combination of several factors such as a speaker volume, placement of mics and loudspeakers, and room acoustics.

### ***What can you do about feedback?***

- Move the microphone closer to the desired sound source
- Use directional microphones (cardioid, supercardioid, etc.)
- Reduce the number of open microphones
- Try to keep microphones and loudspeakers as far away from each other as possible.
- Acoustically treat the room (if possible) to eliminate hard, reflective surfaces such as glass, marble, and wood

If all else fails and you have consistent problems with feedback and a budget to solve this issue you can look toward equalizers and automatic feedback reducers.



## PART SIX

---

# A Handy Starting Point for Your Pre-Shoot Checklist

So you are about to embark on a shoot for one of the applications listed prior or something more unusual. Having a checklist, and using it, is a great way to ensure you do not forget any obvious considerations.

Since all applications require different equipment and considerations, this checklist is not designed to be comprehensive for any one of them. It is designed to give you a starting point for your own checklist, which you can update as you are more experienced with that application or your own definition of “good sound.”

The most important thing you can do to guarantee good audio is to take the time to conduct a site visit in advance of the event. This will give you a chance to identify acoustic, technical, structural, and logistical factors that you may be able to use to your advantage or will require special attention to circumvent. Either way, you don't want any surprises after you arrive on the day of the event.

### ***Getting started on your pre-shoot checklist:***

- 1) Storyboard for the shots and setups
  - a. Issues identified during the pre-shoot (day before) test
  - b. Monitoring the sound during all set ups.
  - c. Where the gear will be set up
- 2) Equipment list
- 3) Fresh batteries for all battery operated devices
- 4) Questions to ask the venue, presenters, and organizers
  - a. Where can gear be set up?
  - b. Who will/will not be willing to use or wear a microphone? (Do they tend to wander around or remain in a fixed place?)
  - c. Can microphones be visible or hidden in frame?
  - d. If wireless microphones, in-ear monitors, or intercom systems will be used at the event, what wireless gear is already installed at the venue, and what frequency does it operate on that needs to be avoided by your equipment?
- 5) Directions for any presenters or talkers
- 6) Important audio that needs to be captured
  - a. back up audio options for critical capture needs
  - b. can any audio be recorded or re-recorded afterwards?
- 7) Ambient/environmental audio that needs to be captured/avoided

## PART SEVEN

---

# Conclusion and Learning More

### A Few Final Words

The most important thing you can do to improve the audio quality of your productions is to plan ahead.

Develop a storyboard of what you will be shooting and what audio is needed, as well as how you plan to capture it.

When you walk into a room to begin setting up your equipment, take a good look around you. Identify things that might cause a problem with your audio (such as air conditioning ducts) as well as those which you might be able to use to your advantage (such as sound absorbent carpeting in one section of the room).

Think about what or who you will be miking, and what your options are in getting the sound. Also think about whether they have any experience using microphones or how distracted they might be by their script or other concerns. DO NOT assume they will be thinking about your audio.

Don't be afraid to experiment with different mic placements, but don't gamble an important project on a method you've never tried before.

When you monitor your audio (read: *always* monitor your audio), listen carefully for anything that sounds unnatural. As the saying goes, "If you notice the sound, there's something wrong with it."

The Product Selection Charts, which can be found later in this booklet, identify some Shure microphones, monitoring solutions, mixers, and accessories frequently used in audio/video applications. Further information on Shure products, as well as additional application and technical information, are available to audio/video production professionals at no charge. You can visit [shure.com](http://shure.com), contact us by phone at **1-800-25-SHURE**, or send mailed requests to:

**Shure Incorporated**  
**Customer Service**  
**5800 West Touhy Avenue**  
**Niles, IL 60714-4608**

## MORE SHURE RESOURCES

### Application and Product Videos:

The Official Shure Incorporated YouTube channel can be found at [www.youtube.com/user/shureinc](http://www.youtube.com/user/shureinc).

The Shure YouTube channel includes many *how to* videos, product descriptions and features, artist and engineer interviews, as well as other valuable content to help microphone users and audio professionals stay on top of advancements and get the most out of their audio equipment.



### Educational Guides:

Printed and electronic versions of the following guides are available free of charge. To obtain your complimentary copies visit [www.shure.com](http://www.shure.com).

- Selection and Operation of Personal Monitor Systems
- Selection and Operation of Wireless Microphone Systems
- Microphone Techniques for Sound Reinforcement
- Microphone Techniques for Studio Recording

## ABOUT THE AUTHOR

### Chris Lyons

Chris Lyons is **Senior Manager, Conferencing Market Communications**, with Shure Incorporated. With more than 25 years of experience in marketing, training, technical support, and public relations at Shure, he has presented training sessions, created online content, and served as a spokesperson, both in the U.S. and abroad. He has written numerous articles and technical papers, including Introduction to Wireless Systems and Audio For Distance Learning.

## MIXERS

MODEL	INPUTS	OUTPUTS	POWER REQUIREMENTS	PHANTOM POWER	SPECIAL FEATURES
FP33	3 XLR mic/line	2 XLR mic/line (left-right)	2 x 9-volt batteries	Yes; 48-volt also 12-volt A-B	Stereo; very low noise
SCM262	2 XLR mic; 3 stereo RCA	2 1/4" mic/line; 1 stereo RCA	AC only	Yes; 12 volts	Stereo; ducking circuit for voiceovers
SCM268	4 XLR mic; 5 RCA	XLR mic/line; RCA	AC only	Yes; 12 volts	LED peak output meter

## PROBLEM SOLVERS

MODEL	DESCRIPTION
A15AS	Switchable Microphone Attenuator. Provides 15, 20, or 25 dB attenuation.
A15LA	Line Input Adapter. Provides 50 dB attenuation; permits connection of balanced line-level signal to balanced mic-level input.
A15TG	Tone Generator. Produces continuous 700 Hz signal for setting up and trouble shooting equipment; battery operated.
A95U	Low-impedance to high-impedance matching transformer. Male XLR connector on low-Z end; 1/4" phone jack and phone plug included for high-Z end.
A95UF	Same as A95U, but female XLR connector on low-Z end.
A96F	Low-impedance to medium-impedance transformer for connecting professional microphones to camcorders. Female XLR connector on microphone end; two-foot cable with 3.5mm miniplug on camcorder end. Internal filter to block DC bias voltage.
X2u	XLR to USB signal adapter. Built in headphone monitoring with zero latency. 48V DC phantom power for condenser mics.

## MICROPHONES

MODEL	PHYSICAL DESIGN	PICKUP PATTERN	ELEMENT TYPE	SPECIAL FEATURES
SM7B	Stand Mount	Cardioid	Dynamic	VO application, warm and smooth sound
SM27	Stand Mount	Cardioid	Condenser	Multi-purpose, large-diaphragm, side address
SM58	Handheld	Cardioid	Dynamic	Crisp, clear sound, very reliable
SM63L, SM63LB (black)	Handheld	Omni	Dynamic	Great interview mic; heavy-duty shock mount
VP64A, VP64AL (long)	Handheld	Omni	Dynamic	Neodymium magnet ergonomic design
VP89	Shotgun	Line/Gradient	Condenser	Highly directional VP89S: 70 deg pickup angle VP89M: 50 deg pickup angle VP89L: 30 deg pickup angle
VP82	Shotgun	Supercardioid/lobar	Condenser	Compact and lightweight
VP83	DSLR camera mount	Supercardioid	Condenser	Compact mic for DSLR
VP83F	DSLR camera mount	Supercardioid	Condenser	Compact mic with internal flash recording capability for DSLR
MX183	Lavalier	Omni	Condenser	Small size; bright sound
MX184	Lavalier	Supercardioid	Condenser	Directional pattern rejects noise
MX185	Lavalier	Cardioid	Condenser	Directional pattern rejects noise
MX391/O	Surface mount	Omni	Condenser	Low profile design
MX391/C	Surface mount	Cardioid	Condenser	Directional low profile
MX150B/O	Wired/wireless lavalier	Omni	Condenser	Subminiature
MX150B/C	Wired/wireless lavalier	Cardioid	Condenser	Subminiature
MX153	Wireless headworn	Omni	Condenser	Subminiature; black, tan, cocoa
WCB6	Wireless lavalier	Omni	Condenser	Subminiature; black, tan
WL93	Wireless lavalier	Omni	Condenser	Micro-miniature, uniform frequency response

## HEADSETS, HEADPHONES & EARPHONES

MODEL	DESCRIPTION
BRH31M	Lightweight Single-Sided Broadcast Headset. Features a single supra-aural earcup design that enables the user to hear external audio cues.
BRH440M	Dual-Sided Broadcast Headset. Features circumaural ear cups that block out background noise. Boom offers flip-up mute function.
BRH441M	Single-Sided Broadcast Headset. Features a single-side circumaural ear cup that eliminates background noise. Boom includes flip-up mute function.
SRH440	Professional Headphones. Optimized for monitoring and accurate listening, offering professional sound quality and comfort.
SRH840	Professional Monitoring Headphones. Optimized for recording and critical listening.
SRH940	Professional Reference Headphones. Premium headphones for professional audio engineers.
SE215	Sound Isolating™ Earphones. Detailed sound and a detachable cable with formable wire for easy replacement and a secure, comfortable fit.

## WIRELESS MICROPHONES & IN-EAR MONITORS

MODEL	DESCRIPTION
FP Wireless	For event videography, weddings, one on one interviews. Lightweight, battery-powered, portable receiver for camera mounting; XLR plug-on/bodypack/handheld transmitter options; frequency scan & sync; legendary Shure mic capsules.
UHF-R Wireless	For high end video and broadcast applications. Crystal clear audio; Audio Reference Comanding; XLR Plug-on/bodypack/handheld transmitter options; lightweight, battery-powered, portable receiver for camera mounting; Wireless Workbench Software; legendary Shure mic capsules.
PSM900 IEM	For wireless IFB or remote monitoring. Exceptional audio quality, robust RF performance, category leading set up and operation features.



## **Our Dedication to Quality Products**

Shure offers a complete line of microphones and wireless microphone systems for everyone from first-time users to professionals in the music industry—for nearly every possible application.

For more than eight decades, the Shure name has been synonymous with quality audio. All Shure products are designed to provide consistent, high-quality performance under the most extreme real-life operating conditions.

**SHURE**<sup>®</sup>  
LEGENDARY  
PERFORMANCE™

**United States, Canada, Latin America, Caribbean:**

Shure Incorporated, 5800 West Touhy Ave, Niles, IL 60714-4608 USA  
Phone: +1 847-600-2000 Fax: +1 847-600-1212 (USA) Fax: +1 847-600-6446

**Europe, Middle East, Africa:**

Shure Europe GmbH, Phone: +49-7262-92490 Fax: +49-7262-9249114

**Asia, Pacific:**

Shure Asia Limited, Phone: +852-2893-4290 Fax: +852-2893-4055