

2

Public transport – Planning the networks

Development of principles and strategies for introducing **High Quality Public Transport** in medium sized cities and regions

HiTrans Best practice guide 2

Public transport – Planning the networks

Gustav Nielsen
(Civitas Consultants)

with

John D. Nelson (University of Newcastle)
Corinne Mulley (University of Newcastle)
Göran Tegnér (Transek AB)
Gunnar Lind (Stratega AB)
Truls Lange (Civitas Consultants)

HiTrans 2005

ISBN 82-990111-3-2

An introduction to HiTrans

HiTrans is an abbreviation for “the development of principles and strategies for introducing high quality public transport in medium size cities and urban regions”. Examples of high quality public transport may be light rail, guided busways or frequent, comfortable buses. But the defining criterion of “high quality public transport” is the ability to compete with the private car for everyday travel in circumstances where car ownership is widespread. Established by a partnership of cities and transport agencies in the United Kingdom and Scandinavia, HiTrans is specifically aimed at cities and urban regions in countries bordering the North Sea that have populations between 100,000 and 500,000 people.

The project is jointly funded by the European Commission’s Interreg IIIB North Sea Programme and the following partners:

- ▶ Rogaland County Council, Norway, (lead partner)
- ▶ Aarhus County Council, Denmark
- ▶ Edinburgh City Council, Scotland
- ▶ Helsingborg City Council, Sweden
- ▶ Stavanger City Council and Sandnes City Council (in partnership), Norway
- ▶ Sunderland City Council, England
- ▶ Jernbaneverket, the Norwegian National Executive for building and maintaining railways
- ▶ NEXUS, which operates the metro in Tyne and Wear, England
- ▶ NSB BA, the Norwegian National Railway operator
- ▶ Oslo Sporveier, which plans and operates the bus, tram and metro network in Oslo, Norway
- ▶ Statens vegvesen, the Norwegian Public Roads Administration.

The North Sea region is characterised by urban networks with few large but many medium sized cities and urban regions. Urban land use is generally low density when compared to other parts of Europe. There are also similarities in terms of urban culture and climate in the North Sea region that can affect the use of different transport modes. Car ownership and usage in European cities is generally increasing, and providing public transport that can compete with the private car is a challenge throughout Europe. But there are some challenges that particularly

apply to medium sized cities and urban regions. In contrast to that of large cities, public transport in medium size cities and urban regions tends to be based on relatively low quality bus services. Smaller populations and thus lower passenger demand mean that expensive infrastructure such as heavy rail or subways cannot normally be justified.

Medium size cities that are looking for alternatives to normal bus services rarely have the resources to adequately research the advantages and disadvantages of emerging technologies and concepts of high quality public transport, particularly as these would apply in their circumstances.

HiTrans is a cooperative research effort to obtain this knowledge; to find suitable and cost effective solutions for such cities, and to learn from the best examples of relevant cities throughout the world.

But the aim is not just for high quality public transport. The aim is for high quality cities.

Most new concepts of high quality public transport require new infrastructure. It is a challenge to make such infrastructure fit into – and better still, enhance – the qualities of the urban landscape.

High quality public transport can also be used to restructure our cities to enhance the accessibility of the people who live in them without the choking traffic that diminishes our quality of life. At the same time it is expected that spatial planning oriented towards a city’s high quality public transport network can be a critical factor in building patronage that in turn can justify more service.

HiTrans’ work has been organised through 5 work packages called *strands*. This work has resulted in 5 best practice guides.



Best practice guide 1

Public transport & land use planning

How can we reshape our cities to facilitate the use of public transport? A series of case studies provides some inspirational illustrations of what can be done – as well as some salutary lessons of what to avoid. There are examples of cities regenerating run-down areas, curtailing urban sprawl, building successful public transport oriented communities, ridding themselves of traffic-choked city streets, as well as

examples of cities reinventing themselves as attractive places in which to invest and to live.
Main consultant: Lynn Devereux (WSP, Cambridge)

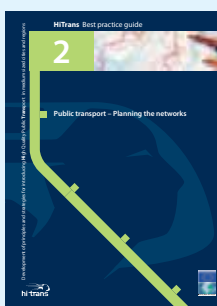

Best practice guide 2

Public transport – Planning the networks

Medium size cities face special challenges when introducing high quality public transport. How can the patronage be raised to generate the frequencies needed to make public transport a viable alternative to the car? This challenge is on top of well-known dilemmas that lie behind questions such as how far apart stops should be and whether resources should be spread between dense network of routes,

or concentrated in a few, higher frequency routes. Illustrations and graphs demonstrate principles of network design, introducing concepts that simplify and clarify the planning public transport services. Also the report gives an overview of various legislative frameworks and their effects on the provision of public transport.
Main consultant: Gustav Nielsen (Civitas, Oslo)

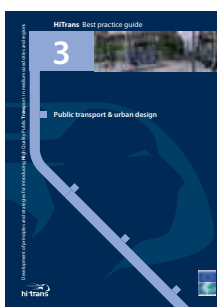

Best practice guide 3

Public transport & urban design

The introduction of high quality public transport can have profound implications for a city's urban design. It may be introduced with-out any thought about how it will look or its impact on people's ability to move about and enjoy the city's public spaces. On the other hand, it may be carefully designed to reinforce or en-hance these aspects – or to play a crucial part in the reinvention of the city's image. This guide

uses case studies to examine the variety of urban design factors that should be considered when introducing high quality public transport: overhead wiring, rails, signs, stations, stops, guideways, safety barriers, as well as the vehicles themselves. It also provides advice on advertising and preventing vandalism.
Main consultant: Marie Burns (Burns+Nice, London)

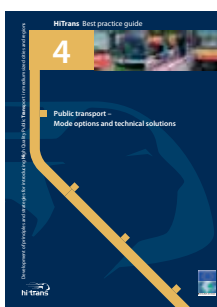

Best practice guide 4

Public transport – Mode options and technical solutions

There is a wide range of options available for those planning the introduction of high quality public transport. Rail-based options range from ultra light rail to heavy rail, with various permutations and combinations such as tramtrains, light metros, metrotrains and so on. Cities opting for bus-based transport will have to choose between different forms and combinations of propulsion, as well as

whether to use bus only streets, busways, and/or to adopt one of the evolving technologies to guide buses. The experiences of numerous cities are used to provide lessons of how to introduce cost effective solutions that suit the local circumstances, and avoid costly mistakes.
Main consultant: Trevor Griffin (Interfleet Technology, Derby)

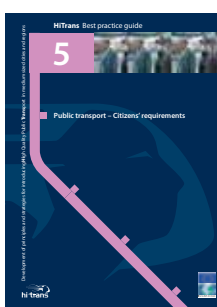

Best practice guide 5

Public transport – Citizens' requirements

This report investigates what the citizens of medium sized cities require from the public transport system. The report is split into two parts. Part 1 is a desktop study analysing the findings of previous research into the requirements of both users and non-users of public transport. Part 2 presents case studies of medium sized cities and regions that are perceived as being successful in providing high quality public

transport. The study identifies the qualities that have made a difference, as for example fare structure, speed, reliability and frequency.
Main consultant part 1: Alan Howes (Colin Buchanan and Partners, Edinburgh)
Main consultant part 2: Tom Rye (Napier University, Edinburgh)

Foreword

This Best Practice Guide on Public transport network planning is the result of research and authoring processes in the HiTrans project Strand 2 in the period from September 2003 to June 2005. After the first Working Group meeting no. 1 in Oslo on October 16th–7th, 2003, decisions were made about the main contents and topics to be dealt with in the guide. The first and second draft versions of the guide were presented and discussed with HiTrans Partners at the Working Group meetings no. 2 in Newcastle on March 11th–12th and no. 3 in Karlsruhe on October 7th–8th, 2004. Final editing with illustrations and photos has taken place in the first half of 2005.

The first drafts and later corrections of the chapters on institutional issues have been written by Corinne Mulley and John D. Nelson at the Transport Operations Research Group, University of Newcastle, Newcastle, UK. They also had the main responsibility for an international literature review supporting the guide, and they have given advice on issues of terminology.

Göran Tegnér at Transek AB, and Gunnar Lind at Stratega, both transport consultants based in Stockholm, Sweden, have written the first drafts of the chapter on methods and tools of public transport planning. Gunnar Lind also had main responsibility for the HiTrans Partner Study – a questionnaire study of various aspects of urban structure, public transport planning and institutional aspects in the HiTrans partner city regions.

Civitas Consultants in Oslo, Norway, has been the main consultant with overall responsibility for the international team and the final documentation in this report. Gustav Nielsen, Civitas, has been the project manager, responsible for the drafts for the rest of the guide and the final versions of all chapters. Truls Lange, Civitas, has been co-author with special responsibility for illustrations, and he has made the design and layout of the guide.

Comments on earlier drafts of the guide have been received from the HiTrans manager for this topic, Terje Grytbakk at Oslo Public Transport Ltd, Oslo, and from other members of the working group. Very helpful and productive comments have in par-

ticular been made by the HiTrans expert advisor Axel Kühn, Karlsruhe, Germany and the HiTrans external editor Ian Radbone, University of South Australia, Adelaide, Australia.

We also acknowledge the contributions made by various sources of photographs and other information, which are mentioned in the captions of illustrations and the lists of sources in the last part of the guide.

The final responsibility for all errors and possible misjudgements lies upon Civitas.

Oslo, June 2005

Gustav Nielsen,
Project Manager

Civitas Consultants
www.civitas.no
gustav.nielsen@civitas.no

Hi Trans Strand 2 members

Terje Grytbakk, Oslo Public Transport Ltd. ; Strand manager

Ken Kemp, Nexus, Tyne and Wear

Truls Oppen, Norwegian National Rail Administration

Hallvor Folgerø, Norwegian Public Road Administration

Bjarne Christiansen, Aarhus County Council

Keith Atkinson, City of Sunderland

Nils Lindgren, City of Helsingborg

Kåre Riseng/Tore Jensen, Rogaland County Council

Axel Kühn, Karlsruhe; Expert advisor to Strand 2.

Hi Trans Strand 2 consultants

Gustav Nielsen, Civitas Consultants, Oslo; team manager

Truls Lange, Civitas Consultants, Oslo

Göran Tegnér, Transek, Solna/Stockholm

Gunnar Lind, Stratega, Stockholm

John D. Nelson, University of Newcastle

Corinne Mulley, University of Newcastle



Contents

Foreword _4

Contents _6

Executive summary _8

Introduction and readers' guide _16

1 Practical network planning for high quality public transport _18

- 1.1 Define the network planning tasks _19
- 1.2 Understand the market and the users _29
- 1.3 Determine the network structure _34

2 The institutional context for network planning _42

- 2.1 Understanding the role of planning in different settings _43
- 2.2 Learning from institutional reforms _51
- 2.3 Being aware of the institutional factors behind good practice _60
- 2.4 Gaining support for public transport development _76

3 Network structure design _80

- 3.1 Combining structural stability with market adaptability _81
- 3.2 Exploiting the network effect _84
- 3.3 Defining the main elements _94
- 3.4 Creating the basis for a simple high frequency network _104
- 3.5 Finding strategies for the weaker markets _116
- 3.6 Developing an efficient line structure _120
- 3.7 Travelling as fast as possible _124

4 Methods and tools for assessment of solutions _136

- 4.1 Understanding the need for analytical tools _137
- 4.2 Planning public transport and urban structure _146
- 4.3 Planning for the long term _150
- 4.4 Planning in the short term _159

Glossary _162

References _164



Good network planning and design is essential for public transport success

Network planning and design can be a decisive factor for public transport success. Great differences in service quality, market share and costs of operation will occur depending on the satisfaction of the following key requirements:

- ▶ An integrated network of all public transport modes and different types of operations, with easy and comfortable transfer opportunities at several places in the city region, not only at the main railway station or in the city centre.
- ▶ Exploiting the different quality and capacity aspects of the various modes and services of public transport by putting the right mode and type of service in the right place in relation to customer demand and efficiency of operations.
- ▶ A simple network with a clear line structure that is easy to learn and remember for all citizens, partly due to a well thought out long term planning strategy for the urban structure of land use, public transport and road network of the region.
- ▶ Direct route alignment and the fastest possible speed of vehicle operations with reliable timetables.
- ▶ High frequency services where and when the demand is reasonably high.
- ▶ Coordinated pulse timetables where demand is weaker.
- ▶ Efficient pendulum lines running through city and suburban centres and major public transport interchanges, that connect major housing and working areas of the region to the city centre, suburban centres and public transport nodes.
- ▶ Supporting soft measures such as fare structure, ticketing systems, information and marketing, preferably combined with restrictive policy measures towards car use that can significantly influence public transport demand and the success of all the other measures.

Taken together, these aspects stand between outstanding success and complete failure for public transport in the transport market of small and medium sized cities and regions.

In order to fully exploit the opportunities, professional analysis of the market and all the different measures is needed. And many stakeholders must be brought into the planning and development process. This requires the set-up of an institutional framework which supports this type of work. It goes without saying that a pure free market competition regime will not be able to do the job. Neither is a single "old-fashioned" government monopoly likely to succeed. By looking into the experiences of different institutional frameworks in many countries, advice on the organisational and procedural aspects of public transport network planning can be extracted.

The report is presented as a guide to best practice in network planning. However, what constitutes good or a bad practice depends on the context. What works well in one urban setting, will not necessarily do so in a different situation. In a particular city region, the objectives of the public transport policy might differ, and institutional arrangements will highly influence the choice of solutions. Also local cultural, social and political factors and values affect what is achievable. They will often be decisive for what is considered to be good solutions in a particular place.

Therefore, there are no short cuts to the best practice solutions. This guide cannot give a definite recipe for success. It can only give some advice on the questions to ask and the main considerations to investigate.

Car competition and cost efficiency as the main criteria of success

In the context of HiTrans, by high quality solutions we mean solutions for public transport systems that are able to be a competitive alternative to the motor car for urban travel. This is a far-reaching quality ambition, which means that it is difficult to find practical examples that fully live up to the expected level of quality.

In order to fund the necessary quality, the public transport system must also be cost-efficient in the development and operation of the system. The costs of operation also influence the level of fares that

users must pay. So both efficient use of resources and high quality service to the passengers is needed. Good network planning can make a very significant contribution towards both these two objectives.

Nevertheless, it must be recognized that competitive, high quality public transport can never be cheap. In most small and medium sized cities today the public transport system does not compete very well in the urban transport market. At the best it manages to keep its market share in the central parts of the urban region. Increased market share at the expense of car traffic has only been achieved in some city districts and regions where high quality public transport is integrated with urban planning and development and combined with restrictive policies towards car traffic and parking, and with pricing mechanisms and tax laws that stimulate the use of public transport as well as cycling and walking.

When looking for examples of good practice to be included in this guide, we have taken a pragmatic approach, based on theoretical reasoning about some of the main characteristics of urban public transport networks. As indicators of success we have been looking for information about increase in market share, cost-benefit indications and customer satisfaction, but we have also used our own judgement of what we consider to be "clever" solutions.

Define the network planning tasks

Network planning is diverse and complex. Diversity comes from the variety of institutional, legal and organisational contexts that exist in different cities and countries as well as the mixed political ambitions and the various types of urban structure that public transport must cater for. Complexity comes from the different time perspectives that must be dealt with; the conflicting goals and interests; the need to make use of knowledge and competence from a number of different professional fields; the variety of possible solutions available; and the need to consider local circumstances, different user groups and market segments.

When embarking on public transport development and network planning, it is crucial that the

planning task is properly defined. The goals and objectives should be clearly stated, and the relationships between the objectives and use of the limited resources should be considered.

A relevant question to ask is: What role does the society want the public transport system to fulfil? Is the ambition limited to giving a basic service to people unable to cater for their own transport? It will be useful to define a minimum standard of service that the public will secure for all citizens in the region. With higher ambitions, the task of public transport network development might be to relieve car traffic congestion in peak periods, in order to improve the transport efficiency of the city. In HiTrans, however, the main emphasis is on high quality public transport that is able to replace car use as a significant measure to create a more sustainable and environment friendly city region on a long term basis.

The institutional context will to a large extent define the scope of planning, and the role that should be given to the different types of market forces. The study area must be defined, and by this, which elements of the regional network that should be considered together with the city services. The time perspective and the scope for the development of new solutions will also decide how the network planning task should be carried out and the freedom one has to choose completely new solutions and even new modes of public transport.

Understand the market and the users

Good understanding of the market, and the user and non-user demands and requirements in the particular urban region is a prerequisite for the development of an attractive and competitive network. The various factors that affect the demand for public transport should be well understood. The connection between land use and public transport is also very important. Network development should take account of the urban structure and the varying densities of demand.

Taking account of user requirements and preferences is important. Public transport development should, however, not only be concerned

about adapting the services to all different types of perceived market demands. It is equally important to improve the way the system presents itself to the existing and potential customers. Travel habits and customer preferences may be influenced by new, creative concepts and solutions. Making a public transport system that is simple and easy to understand is an important aspect of network design that has often been overlooked.

Determine the network structure

Different user requirements may be in conflict, and there are limited resources for the demanded public transport services. The design of network structure involves making selective choices and solving important dilemmas. There are few simple and general answers. The recommended principles of good practice are sometimes contradictory. Local circumstances and political objectives are often decisive.

Network planning is hard work. But since the outcome might heavily influence the success or failure of public transport, it deserves a lot of reasoning, calculation and discussion between well informed persons. The tools of practical planning should support a process of drafting, analysing and redrafting network proposals. Even in the time of the ever more powerful and user-friendly computer, the traditional tools of the map, colour pencils and sketching paper are very practical in facilitating open and creative discussions among planners.

A network strategy for meeting the challenges must take account of the fact that the essence of a public transport system is the concentration of passenger flows onto specific lines of movement. Transfer is an inescapable feature of many of the journeys that can be made by public transport. Consequently, how interchanges are designed, and how services are organised and presented, is at the heart of the overall strategy of improving public transport.

It is often fruitful to start the network planning process with an analysis of the strength and weaknesses of the existing network, thus defining challenges for network improvement. In this analysis it is useful to think of the various groups of custom-

ers that might use the system for different travel destinations and purposes. The planner should also consider the lines and the network from the practical operators' point of view.

Then it might be useful to continue with an attempt to define the main network that is wanted in the long term, before one tries to find the short term solutions and the flexible local network and demand responsive services that supplement the main network. The following work structure may be considered:

- ▶ Start with the heavy infrastructure and main transport demand corridors in the future.
- ▶ Serve all major corridors with as few high frequency lines as possible, creating pendulum lines between corridors on opposite sides of the city centre.
- ▶ Look for suitable tangential routes or corridors that might work together with the radial lines to form a more complete travel network for the city region through the integration of services and interchanges.
- ▶ Consider urban and regional services at the same time, in order to find the best combined solutions for both users and operators.
- ▶ Look for pulse timetable routing where travel demand and frequencies are low.
- ▶ Analyse the possible roles of different rail modes and different types of bus line operations.
- ▶ Study how access to the trunk line network can be improved; through bus service improvements, interchange development, the provision of bike-and-ride and park-and-ride facilities, and through the improvement of roads etc for car users, bicyclists and pedestrians.

Understand the role of planning in different institutional settings

What constitutes high quality public transport is defined by the objectives of the decision makers and the institutional regime they are working under. The network planner should understand the rationale behind the different types of institutional contexts public transport planning must adjust to.

For operational purposes at any one point in time, the institutional context is given. However, when organisational change is being considered, it is useful to take account of research on how the different institutional settings affect network planning and the conclusions from studies of barriers and stimulations to the development of successful high quality public transport.

Much can be learnt from looking at public transport planning in a broad international context. For such planning to be successful, it is necessary to understand the organisational structure, the interplay between institutions and the urban transport market, and the dynamics of the public transport sector. Three pieces of advice can be noted.

First; recognise the imperfections of the urban transport market. Both in theory and in practice the objectives of a competitive, high quality public transport service create a clear need for network planning.

Second; define the scope for planning according to the degree of market regulation in the actual city region. With a public service approach to public transport, the role of planning is obviously much greater than in a city region where the free market approach has been chosen. Experiences and solutions from these two different institutional contexts are often difficult to transfer in practice.

Third; best practice is to combine the advantages of integrated planning with the advantages of market competition off the road. Public planning can harvest the benefits of network development and coordination between land use, public transport and general transport policy. Through the tendering of public transport operations, infrastructure development and maintenance, also much of the benefits of the market approach can be achieved. Planning and competition are not necessarily contradictory. It is more a question of appropriate allocation of the roles of the two approaches in the institutional setup.

Learn from institutional reforms

Some clear trends emerge from the review of public transport markets around the world. There has been a greater role for the private sector in the provision of urban transport services, although the motivation for doing so may differ greatly. The transport authorities have typically retained the initiative for the planning of the network, integration of services, and specifying the quality of the transport product. There has been a wide range of options for specifying services. To illustrate the experiences from institutional reforms and the implications for public transport network planning, the cases of “on” and “off” road competition are explored.

It can be noted that the introduction of on the road (more or less) free market competition in the UK outside London since 1986, has not resulted in any general improvement in services or turn-around of the continuing decline in bus patronage. On the contrary, the London region where a more regulated institutional framework has been kept, is the only large urban conurbation in the UK with a significant long term growth in bus usage (40 percent growth from 1982 to 2001) and in overall public transport patronage.

In many cities in Scandinavia and UK the cost per buskm was reduced by some 10–30 percent during the first years after the introduction of competitive tendering of bus services in the 1990s. However, after some years of this type of regime, the number of competing operators has been significantly reduced to a handful of mainly large national and international operators. Costs have been stabilized or even increased somewhat again. The tendering contracts are now being developed to give more emphasis to service quality aspects. The importance of contracts that give the actors incentives to improve quality and increase the market share in relation to the motor car has been more heavily focused in recent years.

A study of different organisational reforms and changes in urban regions in four different European countries has drawn attention to the importance of a multi-disciplined approach to public transport organisational reform. Organisational models based

on a single professional rationality are unlikely to succeed. The advice is to combine several different professional paradigms as structuring forces in the attempts to improve public transport organisations.

Be aware of the institutional factors behind good practice

Good practice in the provision of high quality urban public transport is not only to provide a 'better' service for existing travellers, but additionally to motivate modal shift away from private transport. Different cities have different levels of problems (perceived and actual) with their current modal split between public and private transport, but share a desire to lower the proportion of urban trips undertaken by private car. Transport policy research has identified institutional factors that might be considered essential for good practice:

- ▶ All large urban regions with success in public transport policy have a strong regional organisation that integrate public transport services into regional networks and policies
- ▶ Many different regional models are workable
- ▶ A strong public commitment to finance public transport is a pre-requisite for high quality public transport
- ▶ Economic incentives to operators are needed, but can take different forms
- ▶ Soft measures can play an essential role
- ▶ Push and pull strategies must work together
- ▶ Interaction with public policies outside transport is important.

Gain broad support for public transport development

In democracies the development of high quality public transport is only possible with strong political support. Support for public transport development is based on trust and confidence, which comes from living up to expectations. Quality solutions and efficient use of resources are prerequisites to this. All this is only possible through professionalism in all aspects of planning and operations.

Local politics has been decisive in many cities' public transport developments. Co-operation with local stakeholders and alliances with interest groups is also essential for success. Managers and politicians responsible for public transport must demonstrate the ability to achieve good results and create alliances by exploiting the positive external effects from high quality public transport solutions.

To have long term success, the public transport system must form the backbone of urban structure and development and have a stable and high quality service over many years. This stability is a precondition for influencing urban property development and land use and creating an urban structure that supports public transport as a major mode of transport. Therefore it should be more or less guaranteed by the public transport and land use planning authorities of the urban region. This is necessary to safeguard the long term stability that is necessary for achieving the demanded high quality and increased market share for public transport.

Design a network that combines structural stability with market adaptability

In the design of public transport networks conflicting objectives and interests must be reconciled. The public transport system should be able to adapt dynamically to the changing demands of the citizens and the economic circumstances of public transport operations. At the same time, long-term stability of a high service quality is required for the public transport system to influence urban development and create more sustainable transport patterns. The planning challenge is to find the balance between a stable and robust main network and infrastructure and the right level of adaptability and flexibility.

In order to succeed in the market competition with the motorcar, most of the resources of the public transport system must be directed towards the main transport corridors. But such concentration of resources in an urban region must also be related to the need for a minimum transport service to all citizens irrespective of car availability, physical abilities and area of residence.

Exploit the network effect

When the aim is to compete with the motorcar for travel in urban regions two crucial qualities of the system are: short waiting times between departures; and an integrated network of services between all areas of significant transport demand. A system without these two qualities can never be a real competitor to the car as the main mode of transport.

Therefore network planning must find ways to concentrate resources to a sufficient number of high frequency lines that form a travel network that caters for a major part of the demand for motorised transport in the city region. In order to achieve this, planners should try to develop urban services with optimum frequencies of some 6–12 departures per hour. This will allow a majority of users to “forget the timetable”, and higher frequencies give little additional benefit in terms of reduced waiting time. Instead they create problems of congestion and environmental disturbance in densely developed urban areas.

At this service level the capacity of standard bus services may not be able to handle high levels of demand. The capacity may then be increased by using larger buses, or by developing light or heavy rail services. The latter options will depend on the availability of rail infrastructure or funds for building new infrastructure. Needless to say, they will require significantly higher levels of urban density and travel demand.

Create a simple high frequency network

The structure of lines in the network can significantly affect the efficiency and attractiveness of the public transport system. Some principles for the development of an efficient and attractive network should be considered:

Fast and punctual operations at the highest possible speed of service are a key factor. The operational speed determines both the cost efficiency and the attractiveness of the public transport system. A high quality system cannot make many compromises on this aspect of the service.

When fast and reliable routes are established all over the city, the network should be developed with as few, continuous and high frequency lines as possible. In general, pendulum lines should be preferred. They create more opportunities for direct travel and will normally also achieve better use of the transport capacity offered. But they require a high level of priority on the route.

The pendulum principle is applicable not only in relation to the city centre and the rest of the inner city. It should normally also be applied to suburban centres and feeder lines to railway stations and other public transport interchanges in the outer parts of the city.

With reliable and undisturbed operations it will also be possible to synchronise the timetables of different lines running along the same route. This can extend the part of the network that offers high frequency “forget-the-timetable” services.

Cities like Jönköping and Kristiansand are having success, in terms of attracting more passengers and improving operational efficiency, by developing high quality bus lines with the following characteristics:

- ▶ Stable, high frequency services on a few major pendulum lines serving the main transport corridors. They connect major housing areas, suburban centres and concentrations of work places with the inner city, including the main railway station and transport interchange of the city.
- ▶ Fast and straight routes with strong bus priority measures that facilitate strict timetables with very few service delays.
- ▶ High quality vehicles with low floor and generous door openings and ticketing systems that allow for comfortable and fast handling of passengers at all stops.
- ▶ Simple and clear design profile and information design supporting the branding of an attractive and reliable high quality service which is actively marketed to all citizens and visitors of the city.

Find strategies for the weaker markets

In large European cities, with half a million inhabitants and more, it is easy to find corridors with

sufficient demand for the creation of high frequency services. In smaller urban areas, the design of the network structure is more critical for the possibilities of creating high frequency services and corridors. Also for most regional public transport services, there are few opportunities for high frequency services. The regional services cater for fewer, but longer journeys, and discussions about service levels often evolve around 30, 60 or 120-minute headways.

The main service solution to the problem of low demand is the integrated network with pulse timetable. This will minimise waiting time at interchanges and secure a maximum of travel opportunities for a limited amount of operational resources.

The design of the interchange points is a crucial factor, which affects not only the convenience and comfort of transferring passengers. The terminal time of the vehicles also influence the attractiveness of the system for people travelling past the interchange as well as the efficiency of the whole operation. Compromises on the design of these points of the system can largely destroy the success of a public transport network.

Make services as fast and routes as short as possible

Travel time is a major consideration when people choose to go by public transport or not. The gross speed of the public transport vehicles is also a highly significant factor influencing the cost of operation. Therefore, network planning should seriously consider all possibilities for the speeding up of services. In most cities public transport may be improved by the speeding up of operations. Clearly, the best results are achieved by working meticulously with all factors that influence operational speed:

- ▶ Road network design
- ▶ Priority traffic management and control through bus lanes, priority traffic signals etc.
- ▶ Ticketing systems
- ▶ Optimal location and distance between stops
- ▶ Differentiation and coordination between short (intraurban or intrasuburban) and long journey

(regional) services, with appropriate variations in distances between stops

- ▶ Design of vehicles
- ▶ Design of stops
- ▶ Information management that influence customer behaviour.

The speed of travel is also directly affected by the route alignments. Creating lines that go as straight and direct as possible between the points of travel demand can make the difference between failure and success. Securing the best possible, high quality solutions may require traffic management measures, the building of separate rights of way, new bridges or underpasses, etc.

The design of the road system as a whole, and the detailed design of junctions and other road design elements must be carefully thought out to suite the requirements of a high quality public transport service. In many cities traditional road planning and design has not catered properly for this, and therefore contributed to the decline of public transport market share.

Make use of analytical tools for the assessment of solutions

High quality public transport can only be achieved through good decisions based on analytical assessments of solutions founded on sound theory and precise knowledge of the real world.

By tradition, public transport operations have been a practical, non-academic business. The use of scientifically based analyses and systematic modelling and appraisal has been limited. Significant benefits might be gained from a more analytical approach to public transport system and network development, based on sound methods and tools and good data that reflect the real world.

At the strategic planning level it is important to judge the market for new or altered public transport services. The task might even be to estimate the impacts to the society of an entire new public transport network. The demand for a public transport line in an urban area is tricky to capture at a reasonable level of certainty. Investment and operating costs

are usually of a significant size, when considering the whole economic lifetime of the project (often 30–40 years or more). The demand is highly sensitive to the local competition from other modes of transport, such as walking, the bicycle and the motor car. Therefore there is a need for a detailed assessment tool to ensure that benefits are reasonably correctly estimated.

Short-term oriented public transport planning is just as important as the more medium-term and long term planning issues. It is therefore good practice to devote proper efforts to this form of public transport planning as well.



HiTrans' main objective is to *"Examine principles and strategies necessary for introducing better and more competitive high quality public transport in medium sized cities and urban regions of between 100.000 and 500.000 inhabitants"*.

The term "competitive" is used to indicate that the main focus is on the competition between public transport and the use of the private car in these urban regions.

HiTrans objectives for Strand 2

The focus in Strand 2 is on principles and methods for network planning for public transport in towns and regions with restricted budgets, and specific regulations and institutional contexts. The question is how to develop and implement customer-oriented and financially solid public transport networks, and identify any possible needs for new infrastructure.

The three main objectives of Strand 2 have been stated as:

- ▶ **Identify institutional conditions** for optimal network development, i.e. how organisational, legal and financial frameworks can restrict or stimulate the development of more optimal solutions.
- ▶ **Examine and define optimal characteristics** of coordinated public transport networks. By "optimal" is meant efficient use of limited budget resources in relation to the goal of a competitive public transport system through the use of both "soft" and "hard" measures.
- ▶ **Identify suitable methods and tools** for the assessment of solutions for optimal public transport, with specific focus on the "border area" between bus and rail solutions.

The main result from Strand 2 is this document, the Best Practice Guide (BPG). The three sets of questions that are identified by the main objectives are dealt with in three of the main chapters in this document, respectively in chapters 2, 3 and 4. In addition, chapter 1 gives an overview of the practical planning aspects and connects the topic of Strand 2 with the other strands in the HiTrans project.

The aim of the guide is to give advice on the basic principles for efficient, competitive and attractive public transport networks, and to assist the structuring of network planning at the regional and local level in medium sized cities in the North Sea (Inter-reg) countries.

Literature and partner studies

Much of the input to the BPG has come through the two other main tasks in the Strand 2 study:

- ▶ The international literature study, and
- ▶ The HiTrans Partner study.

The international literature study has been based on systematic literature search by the University of Newcastle (UNEW) and Civitas, as well as proposals and references from the Strand 2 expert advisor. The most important references are given in the reference section at the end of the guide.

The HiTrans Partner Study has been the responsibility of Civitas, Transek and Stratega, and was carried out by the Partners answering questionnaires designed by the consultants in cooperation with the working group. The study has resulted in a separate working paper focusing on:

- ▶ Quantitative indicators for describing the urban and transport situation of the partner cities.
- ▶ Discussion of each city's public transport network challenges.
- ▶ Description and evaluation of the methods and tools that are used for network planning in each city or region.
- ▶ Institutional barriers and stimulations to optimal network design.

The information from the partner cities has been taken into account when writing this guide. In addition the guide is based on the consultants' previous work and experiences and some very useful inputs from the Strand 2 expert advisor.

Outline of the guide

The first chapter of the guide is an introduction to public transport network planning, with the aim of giving an overview of the planning process and some practical advice on how to approach this type of planning. Reading this chapter will give the policy maker and generalist planner an understanding of the context and main themes of public transport network planning.

For the readers wanting more detailed insight into the field, there are three additional main chapters dealing with:

The institutional context – with an aim of giving some understanding of the various types of planning and market situations that define the role of network planning, and some advice on how the institutional settings may contribute towards better practice in

the development of networks for high quality solutions.

The principles of network design – with an aim to give advice on how the network may be improved within realistic resource restrictions in order to create a more attractive and competitive public transport system.

The methods and tools for the assessment of proposals and solutions – with some references to the sometimes obligatory national frameworks for transport project appraisals.

Finally, there is a reference section and a short glossary. As an aid to further work, the reference section includes some suggestions for more in-depth study.

No easy answers

The guide includes a number of practical examples that support the theoretical reasoning. However, what constitutes a good or a bad example depends on the context. A solution might be "good" from one point of view, and "bad" when looked upon from a different angle. What works well in one urban setting will not necessarily do so in a different situation.

In a particular city region, the objectives of the public transport policy might differ, and institutional arrangements will highly influence the choice of solutions. Also local cultural, social and political values and factors affect what is achievable and will often be decisive for what is considered to be good solutions in a particular place.

Therefore, there are no short cuts to the best practice solutions. This guide cannot give a recipe for success. It can only give some advice on the questions to ask and the main considerations to investigate.



1 Practical network planning for high quality public transport

1.1 Define the network planning tasks _19

- Specify goals and objectives _19
- Define the indicators of success _22
- Define the scope for network planning _22
- Define the area of study _22
- High ambitions in order to compete with the car _22
- A basic, minimum standard of service? _24
- Understand how existing resources contribute to different goals _26
- Different planning situations and perspectives of change _26
- Short term planning _26
- Medium term planning _27
- Long term planning _28

1.2 Understand the market and the users _29

- Understand demand _29
- Clarify the user requirements and preferences _29
- Make it simple _29
- Network design and information affects patronage and system effectiveness _30
- Take account of the urban structure and the systems available _31
- Balance between demand- and supply-oriented network development _31

1.3 Determine the network structure _34

- Towards a two-tier network strategy _34
- Mapping of network structure _34
- Dealing with the challenge of weak demand for public transport _35
- The key role of transfers and interchange points must be recognised _38
- Connect to the inter-regional transport network _40
- Define the main network that is wanted in the long term _40

This chapter gives basic advice on how to handle typical network planning problems as part of the development of high quality public transport. Such planning is diverse and complex. Diversity comes from the different institutional, legal and organisational contexts that exist in different cities and countries as well as the different political ambitions and the various types of urban structure that public transport must operate under. Complexity comes from the various time perspectives that must be catered for; the conflicting goals and interests; the need to make use of knowledge and competence from a number of different professional fields; the variety of possible solutions available; and the need to consider local circumstances, different user groups and market segments. The level of ambition in relation to the market competition with the car should be clarified from the start of the analysis. More detailed considerations of institutional aspects, of network design principles, and of methods and tools of assessment are dealt with in the following chapters.

1.1 Define the network planning tasks

When embarking on public transport development and network planning, it is crucial that the planning task is properly defined. The goals and objectives should be clearly stated, and the relationships between the objectives and how the limited resources may be used, should be considered. The study area must be defined, and by this, which elements of the regional network that should be considered together with the city services. The time perspective and the scope for the development of new solutions will also decide how the network planning task should be carried out.

Specify goals and objectives

Statements about “high quality public transport”, “best practice” and “success examples” can only be meaningful in relation to a defined purpose.

Objectives vary between cities and often change over time. The institutional setting reflects the types of objectives in focus, and the institutional context influences which goals different planners will consider.

As a consequence, in this guide the principles of high quality solutions and examples of best practice have a wide scope. The stamp of “best practice” will be open to discussion, since what is “best” in relation to one objective, will not necessarily be the best solution in relation to another goal. If the main concern of public transport policy is to provide transport service to the elderly, the “best” solutions might be very different compared to what one would recommend if the main objective were to reduce car traffic and improve the city environment.

The following section gives a brief account of the different main objectives that one normally can find in urban public transport policy and planning. The description owes much to some Swiss research reports on public transport in the field of tension between market and politics (Brändli and Bollinger 1996, Mittasch and Oswald 1994), whose main statements have been further developed here.

Five broad approaches can be identified in the framing of objectives for public transport services in an urban region:

Leave public transport to the market. The main public interest lies in making the transport market function so that public transport operators can provide the services that customers are willing to pay for including the service providers’ profits.

Support social policy. The public interest lies mainly in the provision of transport services to those who do not have their own means of motorised transport, and who rely on walking or public transport for their use of society’s services and participation in work, education and social life in general. The basic idea is to give a minimum level of accessibility and mobility to all members of society.

Provide efficient transport. The main public interest lies in giving people an opportunity to choose between individual car use and public transport, by making public transport a more attractive alternative to the car in order to reduce overcrowding of the road system and congestion in city centres. The basic idea is to relieve the road system of excessive car traffic in congested areas and time periods.

Contribute to a sustainable city. Public transport is seen as an essential part of urban structure and city functioning, health and environment, as a public utility of a similar status to those providing the water and sewage, garbage collection and energy delivery systems. The basic idea is to replace car traffic as the major mode of transport and stimulate non-car based and environment friendly mobility and activity in the urban area.

Reach the objectives efficiently. This prerogative would in theory be applicable in all types of institutional and political settings, although in practice the efficient use of resources to achieve the declared objectives is sometimes more or less overlooked. The basic idea is to use as few resources as possible to achieve a certain level of goal satisfaction.

In practical life, all five aspects of public transport goal setting will be discussed. Public transport planning must, at least to some degree, cater for all these different objectives at the same time. Even if the political interest in a particular situation might be in one of these objectives at a time.

Best practice in public transport planning is char-

The field of supply and demand for different public transport objectives

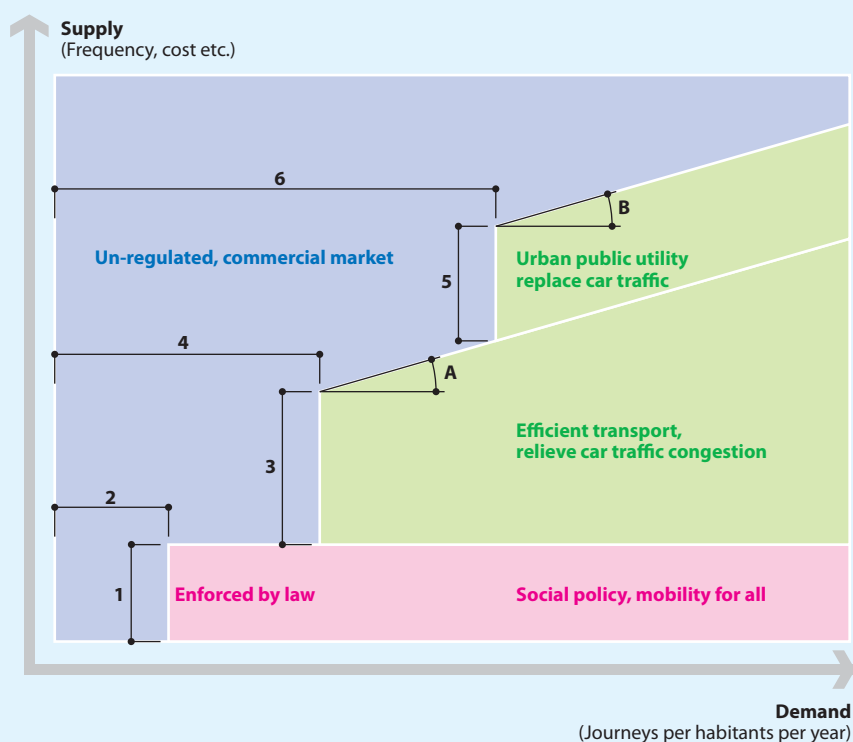

The main objectives of the public transport system have different roles to play in relation to the urban transport market, as shown in the diagram.

If there are no political ambitions for public transport, the supply of public transport services may be entirely left to the operators working in a free market. If one wants to have free competition and avoid the development of private monopolies, the market conditions may still need to be controlled and regulated in order to secure fair and efficient competition between operators.

To achieve the social goal of mobility for all citizens, a supply and demand situation defined politically by **1** and **2** should be developed.

1 Indicates the minimum standard of supply that is considered acceptable in different types of areas, time of the day, week and year. Here the minimum standard of frequencies,

hours of operation, walking distances etc. will be decided as a basis for the planning of the public transport service, which may consist of various forms of flexible, demand responsive services and scheduled, line-haul services coordinated in a transport network. Even standards of accessibility to stops, stations and vehicles will have to be defined in order to avoid critical barriers to the use of the system by disabled and elderly persons. In some countries the minimum level of accessibility provision may be regulated by law.

2 Indicates the minimum demand that follows from the politically defined criteria of the types and numbers of journeys that every citizen has a right to make, even if they have travel disabilities and without their own, private means of transport, including relatives that can take them with them by car or on a commercial public transport service.

To achieve the goal of relieving car traffic in order to provide a more efficient transport system for the urban region, the relevant field for supply and demand for public transport supported by the public funds should be defined by **3** and **4** in the diagram.

3 Defines the increase in service level that is needed in addition to the socially defined minimum standard, so that travellers are attracted away from their cars. The service requirements will depend on the conditions for car use as well as the relative prices of public transport journeys and car user costs. Improving the service level as indicated by **A** will further increase the market share of public transport.

4 Defines the minimum demand and income from fares that is needed to be able to run public transport services with a standard that is attractive enough to compete with individual car transport.

With even higher ambitions for the role of public transport, the system might be further developed to replace car use as the major mode of transport in the urban region. The idea would then be to support the development of a more sustainable urban structure, stimulate land development that is less car dependent and give the region an economic and social vitality without the negative environmental effects of a more strongly car-based city or region. The role of the public transport system would then be quantitatively defined by **5** and **6** in the diagram.

5 Indicates the service level and high quality standards to all elements in the system that this high ambition will need. Improving the service level and quality of the system as indicated by **B** will further increase the market share of public transport.

6 Indicates the volume of demand that is needed for the public transport system to play the desired role as the major transport system of the city.

Adapted from Brändli and Bollinger (1996) and Mittasch and Oswald (1994).

Some key characteristics of public policy in relation to different main goals for the public transport system

	Main goal for the public transport system		
	Mobility for all members of society	Relieve roads of congestion from car traffic	Replace car traffic in order to create a sustainable city
Transport policy characteristics			
The role of public transport in relation to individual car use and it's supporting road system and traffic regulations.	Public transport complements individual car-based transport	Public transport competes with the car system to reduce excessive car traffic	Public transport is the main system for the operation and structuring of the urban region, car transport is complementary
Car traffic strategy	Only minor regulations for functional purposes	Restrictions on car parking and driving in central areas at peak periods	Restrictions on car use and parking in all parts of the region
Public transport supply strategy	Dispersed in time and geography, at the expense of speed and frequency	Corridor concentration of resources to busy axes and periods	Network of high quality lines serving the whole region
Key quality factors	Local accessibility and reasonable fare levels	Quality of service and transport capacity with priority measures in peak traffic	Priority over cars in land use, infrastructure and traffic management
Other key quality aspect	Service friendly personnel, with little time stress	Fast and reliable, specially in main corridors at peak hours	Integrated network of high quality services, with reasonably high frequencies even at low traffic periods
Public finance support for the public transport system	For clearly specified social needs	For improved capacity and quality in peak periods, and reduced fares for regular users	For all aspects of the public transport system in order to keep fares at a competitive level in relation to car use even outside peak periods

Adapted from Brändli and Bollinger (1996).

acterized by the ability to consider all these aspects at the same time.

Define the indicators of success

Monitoring change is necessary for good decision-making and management. Public transport managers and planners need relevant indicators to inform the process of change and improvement towards better quality results.

A set of key indicators of success is needed. Once they have been established and routines for data collection and analysis have been set up, the effectiveness of different actions should be monitored and evaluated. This will start a learning process and form a more solid basis for assessments of new measures at the planning stage.

The indicators should be predictable at the planning stage, so they can be used in the analysis of possible solutions and alternatives before implementation.

Define the scope for network planning

After the broad analysis of policy goals for public transport, it is important to define operational objectives that may be used in the planning of the public transport network.

The scope for such planning will be defined through the institutional set-up and political context, as discussed in chapter 2. The bigger the share of the public transport services that is left to the market competition “on the road”, the smaller is the role of network planning as a public activity.

But even under a regime of widespread competition, such as in the United Kingdom outside the London region, the use of quality contracts and public-private partnerships will require a plan for the network to be developed. Not the least, is it important to ensure that expenditure on infrastructure is directed to projects that efficiently support the operations of the different lines and routes agreed upon.

When looking at examples of good practice from several countries, it is possible to identify some characteristic differences in the approaches to public transport development. They reflect various national,

regional and local objectives for the public transport system, as well as different views on how the “best” solutions should be designed. Such differences stand very clearly out in the policies towards tram and light rail systems in urban regions.

Define the area of study

This guide is about high quality public transport in cities. But this must be analysed in a city regional context, taking into account not only intra-urban travel demand but also travel between the city and its hinterland.

The definition of the study area will influence the scope of the public transport network planning. In some cases the interchange points between the inter-regional and regional transport systems and the city transport system will be predefined. Then the planning project can be limited to deal with the intra-city services.

In other cases the study area and the planning task will be extended to include the public transport services of the whole city region. Then the network study should include an analysis of the most suitable division of roles between regional and local lines and modes in the various transport corridors of the city region.

The requirements of good practice for city and regional services are somewhat different due to the different travel markets they cater for. City travel demand is characterized by many short journeys, and a high capacity and frequency service is the best response to this demand. Regional travel demand cannot support so high frequency services, but the longer travel distances require faster travel speeds than city services can provide.

High ambitions in order to compete with the car

The level of ambition for what the public transport system should achieve will also heavily influence the scope of network planning. In this guide the pre-defined task is to describe “best practice” in relation to “high quality public transport”. We interpret this to mean that we shall mainly describe network planning principles and solutions that work towards

Example of how different policy roles of public transport might affect the strategy of system development

	“More efficient transport by relieving car traffic congestion”	“Sustainable city by replacing car traffic”
	England	France
Political and institutional context	Little focus on car traffic reduction. Since bus transport outside London is unregulated, most of the public transport market is outside government planning.	French urban transport legislation demands a reduction in car traffic. Light rail is seen as one of the means of achieving this.
	Local government initiatives are restricted by little financial freedom. Dependent on central government for most of the transport funding.	Strong city government with a powerful mayor as leader, and a strong local source of public transport funding.
	Light rail is seen as a transport solution only, with little connection to urban planning and development.	City vitalisation through high quality public transport is a source of political status and city pride
	Government responsibility limited to public transport infrastructure and the tendering of non-commercial services. Weak powers for the integration of rail and competing bus operations.	Strong government involvement in all aspects of public transport; infrastructure, service purchase and ownership of operators.
	Organisational separation between central government infrastructure financing and the regional transport executives’ responsibilities for planning and operations.	Organisational split between urban and regional public transport. Multimodal tickets or passes are rare.
Characteristics of light rail projects	Serve the region with better connections between suburbs and the city centre	Improve the main city by high quality public transport. Less concern for suburban transport.
	No link to car traffic reduction policies	Coordinated with car traffic reduction measures
	Much use of existing, old rail infrastructure	Mostly completely new infrastructure, including urban regeneration measures taking some 50 % of infrastructure costs
	Minimise government spending and risk taking by the involvement of private capital	Full public financing
	Many years between proposal and implementation	Often few years from proposal to development and full operation
A common features	Light rail is seen as the best (only) means to achieve sufficient priority in the traffic system.	
Case study cities	Manchester, Sheffield, West Midlands, Croydon (Greater London)	Lyon, Marseille, Montpellier

A Swedish research project has made a comparative study of the development of light rail systems in England and France. The study found big differences in the general approach to public transport in the two countries. This was clearly observed in light rail projects that have been realised in recent years. The differences can be seen as a consequence of different social and political cultures.

But in the context of this guide, this might also be interpreted as a reflection of differences in the goals and objectives for public transport. Also the very different institutional arrangements for public transport in the two countries might be understood as a consequence of different levels of political ambition for the role of public transport.

We compiled the table on the basis of results

from the Swedish study. However, even if the comparison is interesting, it should mainly be understood as a “tale of two countries”. The connections between goals, institutions and public transport solutions are complex, and need careful interpretation to be transferred to other countries and political cultures.

Source: Hylén and Pharoah 2002.



Strasbourg's design and implementation of its modern light rail system signals high ambitions for what the city wants to achieve. PHOTO: GUSTAV NIELSEN

the most ambitious goals for the public transport system, as a definite competitor to the car. Only when achieving this, can public transport become an important element in the development of environmentally sustainable and economically viable urban areas, even in cities with fewer than half a million inhabitants and down to a population of 100,000 and below.

From the research literature on transport demand we are aware of the basic characteristics of a public transport system that is able to compete with the car. The service offered to the majority of potential users with the motor car as a real option must be:

- ▶ Fast
- ▶ Reliable
- ▶ Safe
- ▶ Frequent
- ▶ Comfortable
- ▶ Attractive
- ▶ Simple to understand and use
- ▶ Reasonably priced.

Few cities, if any, are able to completely fulfil all these requirements. A city with high ambitions for its future public transport must be prepared to use a significant amount of economic, professional and political resources on its public transport system.

High quality public transport can never be "cheap". But it is crucial that the resources available are used as efficiently as possible. In this guide we therefore point at some of the most important characteristics of efficient networks.

As we show in this guide, the differences between "best" and "not so good" practice in network planning and design can very often decide between success and failure in public transport policy.

A basic, minimum standard of service?

The emphasis on competitiveness with the car in this guide, means that the goal of social inclusion and mobility for all will receive less attention, although this important aspect of the public transport system must also be catered for. In practical reality there will be discussions and conflicts on what constitutes the minimum level of public transport service provision that all parts of the region should be given. This basic standard of service might be a good starting point for the more ambitious objectives of relieving and even replacing car traffic.

The strategy for network development should therefore be coordinated with the strategy for social inclusion and mobility for all. Although this is not a main topic for HiTrans, it might be useful to start with an analysis of the restrictions on possible solutions that are fixed by the need to reserve some of the budget resources for operations at a minimum standard.

Understand the connection between objectives and use of resources

Operating cost, 1000 NOK per hour

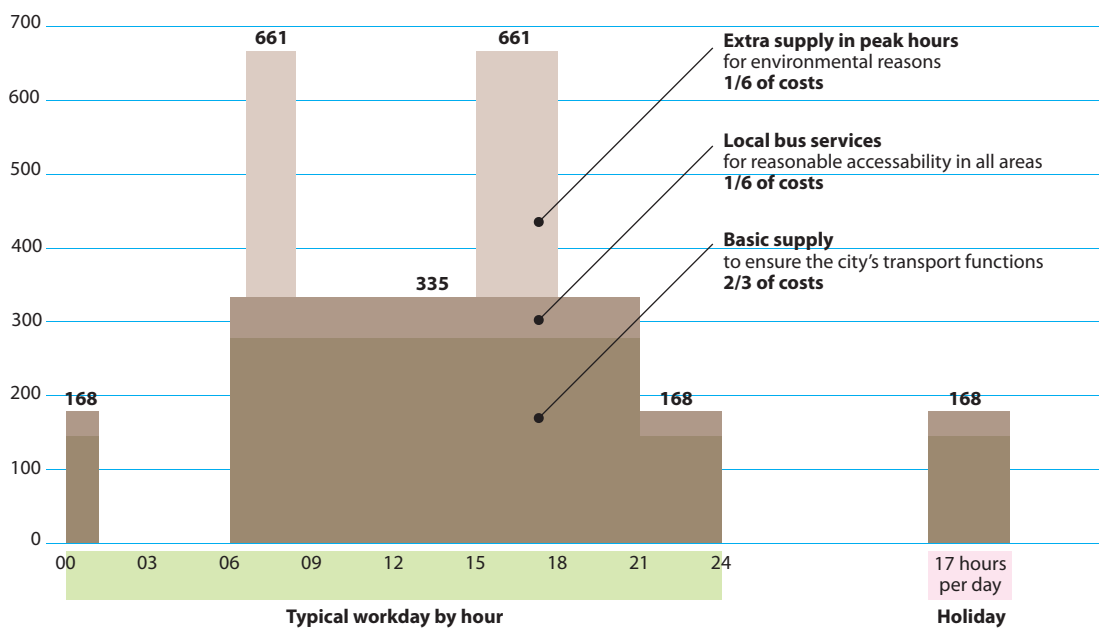

A very simple classification of the supply in relation to the different main objectives of the public transport system is suggested in the diagram. With some information support from studies of the public transport network in the Oslo region, the diagram shows how the operational costs might vary over the day and week in an urban region. It also illustrates how much of the resources are used for the services mainly supplied in order to cater for different objectives. In very rough and simple terms, some

2/3 of the costs of the public transport operations in the region are devoted to providing the city region with a basic public transport service to keep the city functioning without very heavy traffic congestion and delays throughout the day. 1/6 of the operational resources are used for the extra bus services needed to give all housing and working areas of the region a reasonable level of access to the network. The last 1/6 is used for the extra services needed to cater for the peak period demand above the

basic and minimum level of the rest of the day. If and when the public is willing to support improvements in the public transport system, the sensible use of resources (i.e. "best practice") will be determined by which of the partially conflicting goals that should be given priority.

The relationship between level of detail and complexity of methods

	Short term < 1 year	Medium term 2-5 years	Long term 6-25 years
General	Budget planning	Audit and monitoring analysis	Urban and regional structural planning
Semi-detailed	Fares policy	Mode choice decisions	Transport studies Investment planning
Detailed	Crew and vehicle scheduling	Network planning (Route choice analysis)	
	Operational short term planning		
		Strategic long term planning	

Understand how existing resources contribute to different goals

An analysis of the existing use of resources for different parts of the transport network, might reveal which parts of the system that are self-financed by the users, and which services rely on different levels of public support. In the British institutional context of unregulated commercial access to the market, the distinction between commercial services and social services is self-evident. In a more planning oriented context, this question is likely to require more thorough investigation.

Different planning situations and perspectives of change

Public transport planning is an established knowledge based discipline that spans from the detailed day-to-day operational planning of crew, other staff and vehicle planning up to very long term regional planning issues. The nature of the questions to be

answered and the problems to be solved vary enormously.

The political and institutional setting influences the type of questions to be answered in the planning and decision-making process. The investment planning procedure becomes quite different depending on whose funds are at stake. If a private company finances a public transport project, it becomes a matter of revenues and cost calculation. If, on the other hand, it is funded by the public sector, it becomes a matter of social benefits and costs.

Also very different types of analysis are needed depending of the type of measures that are under discussion. Is it a matter of managing and improving an existing public transport network, or is it a question of introducing new heavy infrastructure or even a new mode of transport? This is connected with the question of the time perspective of changes in the public transport system.

One way of sorting out the various steps in public transport planning might be to distinguish between short, medium and long-term planning horizons on the one hand, and the level of detail on the other hand.

Short term planning

In the short-term and at the detailed planning level the task is to provide the daily operations and ensure a reliable service. How should frequencies be adjusted to the continuously changing demand? What are operating hours needed on different lines on weekdays, Saturdays and Sundays, and how should traffic disturbances and vehicle breakdowns be handled? These and numerous other "small" questions must be solved in order to operate a public transport network smoothly and according to planned and announced service standards. Careful responsibility and handling of the daily operations and maintenance of a public transport system is just as important as building new infrastructure, and can have equally large impacts on transport demand and fare income.

In the short term, say in the one-year planning context, fares policy decisions are often made. Fares

Examples of typical questions that require analysis at different stages		
	The extent of change	
	Manage and improve the existing network	Introduce new heavy infrastructure and/or new modes of transport
Long, 6–25 years Structural urban and regional planning	Where to build new housing and employment centres? Main public transport corridors to be improved?	The planning of new public transport infrastructure to be built, where, when?
Medium, 2–5 years Strategic long term public transport planning	The organisation of public transport where at least one aspect of the organisational, financial and legal is no longer a constraint.	How to operate traffic on new planned infrastructure that is being built?
Short, 0–1+ year Operational short-term public transport planning – in effect how to best organise the assets in existence.	The optimisation of existing public transport in the current organisational, financial and legal frameworks.	(Not applicable)

policy decisions are either made at the political level (in countries with controlled competition or with a central planned public transport service), or at the professional level (in more market oriented transport environments). At best such decisions are founded on good practice based on knowledge about price-elasticity and the systems' cost structure.

The most commonly used planning tools are the crew and vehicle scheduling systems (sometimes manual, sometimes automatic). Even for budget planning purposes the use of planning methods and tools should be used.

All these planning examples could be called "tactical" public transport planning.

Medium term planning

In the medium-term, it is more relevant to consider larger changes in the public transport system. The

focus might be to improve the level of service in terms of:

- ▶ Density of network (how many lines or corridors)
- ▶ Type of service (line-haul or demand-responsive, service line, full-stop local bus or express routes, skip-stop service, trunk routes, etc.)
- ▶ Type of public transport mode (bus, light rail, metro, rail, ferry, other)
- ▶ Prices and fare structure
- ▶ Service schedule and frequency
- ▶ Line speed and improvements in right-of-way, bus lanes, elevated or tunnelled sections
- ▶ Type of buses (mini, normal, articulated) and comfort and convenience on board vehicles, as well as environmental aspects.
- ▶ Comfort and convenience at stops and terminals (e.g. weather shelter, platforms, real time information etc.)

- ▶ Information strategy and system branding and marketing.

The questions most often raised by the service provider or by the public transport authority might be:

- ▶ What are the costs (investment, operating and maintenance) of the new service or solution?
- ▶ What are the benefits to the users, who gains and who loses?
- ▶ Is a new service worth the extra money spent on the project?
- ▶ What will be the impact on market shares, traffic safety and air quality of that service?

Relevant planning methods might be network analysis, mode choice models and monitoring analyses. This is the strategic public transport planning level.

Long term planning

In the long-term, the focus is at a higher level of planning, more strongly a part of general transport and land use planning. The more system-wide and general questions might be:

- ▶ Which kind of public transport system suits the planned urban development?
- ▶ What kind of urban development will be made possible, depending on which public transport system will be provided?
- ▶ In which corridors or geographical sectors of the urban region is the need for a complementary public transport system most urgent?

For a complete new town to be equipped with a brand new public transport system, the planner needs to answer questions such as:

- ▶ Which system should be built and introduced?
- ▶ Shall the network be a line-haul system or should it be demand-responsive? What network density should be assumed?
- ▶ How should the system be financed? To what extent should it be subsidized?
- ▶ What are the appropriate fare levels and structure?

The institutional framework for handling such questions is often either a comprehensive urban transport plan for the entire area, or a combined land use and transportation plan. Better practice suggests

that land-use transportation planning produces better results.

Such large-scale decisions often involve a more complex transportation forecasting procedure. This long-term issue could be called urban/regional structural transport planning.

For the sake of structuring the planning process, we discuss short and long term planning in different sections. But in practice, many analyses should consider short and long-term aspects simultaneously.

1.2 Understand the market and the users

For network planning in a particular urban region, a good understanding of the market, and the user and non-user demands and requirements, in that local area is a prerequisite for the development of an attractive and competitive network. The connection between land use and public transport is also very important. Due to limited space and resources, in this guide it is only possible to make a few references to this important topic. Public transport development should, however, not only be concerned about adapting the services to all different types of perceived market demands. It is equally important to improve the way the system presents itself to the existing and potential customers. Making a public transport system that is simple and easy to understand is an important aspect of network design that has often been overlooked, so this is dealt with in some detail.

Understand demand

The analysis and description of the public transport market in terms of land use and user requirements have been dealt with in HiTrans' Strands 1 and 5. In addition to the knowledge they have synthesized, there are several key references in the literature that summarize much of the results from recent research on the demand for public transport. The major international reference is the UK Transport Research Laboratory's recent update of the former "bible" on the topic of public transport demand (TRL 2004). Several Scandinavian sources complement this with more results from evaluation studies and research from mostly small and medium sized cities in Denmark, Norway and Sweden (see the reference section at the end of the guide).

Taken together, the literature forms a solid general knowledge base for the planning of public transport development. However, in addition there is a need for data about local travel needs and geographical patterns in the demand: not only about existing public transport demand, but also about the latent demand of the non-users, especially those that to-day are travelling by car.

Clarify the user requirements and preferences

The same combination of general, research-based knowledge and local information about the user- and non-user requirements and preferences is needed. The development of the public transport network must take account of the documented effects of a number of quality factors on different user's travel behaviour and satisfaction, such as:

- ▶ Different weights of travel time components
- ▶ Resistance against to change vehicles
- ▶ Preferences as to various comfort and service factors
- ▶ The varying importance of personal safety and security
- ▶ The various types of physical barriers affecting accessibility for different user groups
- ▶ Information barriers and varying degrees of information quality
- ▶ Emotional barriers and attractions, including the effect of status and image factors.

In addition to the general research- and study-based knowledge of these factors, the planning process should involve users and potential users in the planning and design of the system and its elements. By this, the planners can also receive information on local needs and factors that should influence the network design.

Make it simple

The importance of "simplicity" of service for the user is an aspect of particular relevance to the development of the public transport network. There are several reasons for why simplicity should be an important consideration in the design of the public transport network.

At a particular point in time, a large part of the users are new to the system, and the turnover in the market is high. Some operators (like Oslo Public Transport) work on the assumption that annually, even with a stable total demand, some 10 percent of their customers leave the system and are replaced by new users. A study of Metrolink in Manchester even found that new individuals replaced some 50 percent of the users over a 3-year period (Knowles

Customer friendly information design

- ▶ Develop clear product concepts concerning naming, coding and properties of different means of transportation
- ▶ Name and code lines in relation to the urban area they serve
- ▶ Avoid irregular routings, schedules and sequences of stops for a line
- ▶ Avoid different patterns and locations of stops for each direction of a line
- ▶ Simplify and standardise how frequency variations and special services such as night buses or peak express services are designed and presented to the public
- ▶ Pursue standardisation, uniformity and clearness of design as well as coherent and homogeneous information by symbols, names, vocabulary, layout etc.
- ▶ Integrate information about the city and the public transport system through location and naming of lines, stations and stops, and on maps and diagrams.
- ▶ Use one common well known name for all stops in the vicinity of each other, irrespective of mode, operator and line. Information about the exact locations of the different stops should be provided at a more detailed information level.

Adapted from Dziekan and Thronicker 2004.

1996). In addition, potential users are most inclined to change their travel habits when they have moved to a new place of residence or changed work. This means that the large section of the population who are changing their travel patterns and habits, are those most sensitive to new information and least informed about the public transport system they might choose to use.

In addition there are good operational reasons for simplifying the network, so this has become an important trend in high quality network development in recent years.

Network design and information affects patronage and system effectiveness

Tarjis and Last (2000) has pointed out that the way in which the network is presented to the public can significantly affect the effectiveness of the public transport system. At the extreme, if passengers are not told about interchange opportunities, they will not plan their journeys to make use of them. More subtly, the way in which the public transport network is promoted to the public, and the role set out for interchange within the network, will have a profound influence on how passengers use the system.

For example, the public usually interpret the intersection of two metro lines on a network map as transfer possibility. But depending upon how it is presented, it could be understood as a place where interchange activity is encouraged, with good facilities, or a location where transfer is not recommended, perhaps because distances between lines are too great, or simply because facilities are poor or non-existent. The promotion of the network can thus highlight, or alternatively downplay, the scope for interchange at particular locations, and hence guide passengers as to where barriers to transfer are least.

Based on current research on user orientation in public transport systems, Dziekan and Thronicker (2004) has proposed an extensive checklist to assist the planners in the development of simplicity and information in public transport. Dziekan (2003) shows that the use of public transport requires a large emotional and intellectual effort of information

collection and problem solving during all stages of the journey. For all non-users this is a significant barrier against the use of public transport, especially for the non-routine journeys.

This means that network planning can make a significant contribution to public transport success by creating a simple and easy-to-understand network of services that facilitates the presentation of the total system for all modes in maps, diagrams, leaflets and on the web.

Dziekian and Thronicker (2004) state that it is necessary to have a single, comprehensive and easy to read map (or diagram) to give the user an overview of the total system with all modes, lines, stops and interchange points that serve the urban area, irrespective of the operator. This requirement is crucial, since it is impossible to fulfil if the system consists of a large number of lines on the same or parallel routes in a dense network with many different types of services, express routes, special peak period services and so on. The importance of this point is underlined by the additional user requirement to combine public transport information with orientation information about the city and the need for detailed street and stop information during travel.

Take account of the urban structure and the systems available

The importance of city structure and urban design considerations for network design are self-evident. HiTrans Strands 1 and 3 cover these aspects.

The technical aspects and the costs of different modes of public transport are described by HiTrans Strand 4, and must also be clearly understood and taken account of in the network planning process.

Density of urban development and the various types of activities heavily influence the applicability of the different modes. Also the type and location of existing rail infrastructure and rights-of-way may be decisive in the choice between bus and rail solutions.

The resources of Strand 2 did not allow for further analysis into the complex field of interaction between network planning, urban structure and

the choice between different forms of high quality systems and solutions.

A couple of existing manuals and research reports on light rail and high quality bus solutions are mentioned in the reference section, and they can be useful for further work on this topic.

Balance between demand- and supply-oriented network development

Obviously public transport planning must cater for the different users' demand for travel, and should be based on a very thorough understanding of the different segments of the market.

However, the market and user oriented focus of public transport planning might lead to some serious pitfalls. These have been described by Mees (2000) as the consequences of the "Bangkok" model of urban transport planning, which he connects with a liberal, unregulated market economy for urban transport. The most important effect of this approach is the segmentation of the public transport market. The idea of market differentiation and tailoring services to various groups of customers will easily lead to a disintegration of the public transport system into separate, uncoordinated and competing services with their own marketing, branding, information and fare systems. Each of the services might be "ideal" for a particular segment of the travellers in the region, but of little use for the majority of the potential customers.

As a contrast, Mees recommends the development of the public transport system according to the supply-oriented planning model of the Zürich region, which is considered a leading city in public transport development and an example of market success in a modern, rich economy. Here the basic aim is to develop a planned and integrated network of services covering the whole urban region, and designing all elements so that the system functions as one, total system which is accessible and attractive for all potential users.

Good practice in public transport planning is to be aware of this dichotomy of thinking about how the transport system should be developed, and try

The demand-oriented “Bangkok model” vs The supply-oriented “Zürich model”

	Demand-oriented “Bangkok model”	Supply-oriented “Zürich model”
The ideal urban transport mode	The car is the ideal mode for urban transport. To be successful public transport must have qualities as similar to the car as possible	Tram, bus, bicycle and walking are the ideal urban transport modes. To be successful public transport must make use of its scale of operations advantage and interplay with walking, cycling and individual motorised transport as access modes.
Demand and supply	Demand controls supply. Deregulation and competition will best satisfy demand, with little need for public financial support. Public transport services should be strongly differentiated for different market segments, as in the car market.	Supply controls demand. Focus on careful public transport system planning in order to reach political goals as efficiently as possible. Plan for standardisation and simplification of public transport services, as in the road system.
The role of public transport	Public transport can only compete to/from city centre and a few other heavily developed business districts, mainly for journeys to work. The car must take most of the travel market in the urban region, even in peak hours.	Public transport should be a viable, attractive alternative to the car for all motorised modes in the whole of the urban area. A combination of public transport, walking, cycling and taxi services should take the majority of journeys, at almost all times of the day/week.
Dominant vehicle size	Small vehicles, to provide as flexible operations as possible.	Large units in fixed operations with long-term stability.
Area coverage	“Black areas” in supply are unavoidable. Develop a sparse commuter based star-shaped network from the city centre.	Full area coverage should be attempted. Develop a strong public transport network covering the whole urban region.
Parallel lines and modes	Parallel operations are OK. Plan for competition between bus and rail.	No parallel operations. Plan for role differentiation between bus and rail.
Important service characteristics	Emphasis on strong peak period express services. Adjustments of timetables to working hours and peak loads.	Combination of bus and rail lines with different market roles. High frequencies and stable timetables most of the day, week and year.
Interchanges	Develop only a few, large mode interchanges, including park & ride sites in the suburbs with special lines to the city centre.	Create a network with many opportunities for high quality transfers. Develop numerous small and concentrated interchanges in numerous network junctions. Provide car and bike parking at many stops and stations of the public transport network.
Marketing	Marketing and branding of single operators and services towards their particular market segments.	Development and marketing of the total PT network for the urban region as a city infrastructure service.
Information	Operator segmented information services.	Full information distribution between all services in the region.
Fares	Cost-oriented fares for each operator and service, including new or extra payment at interchanges.	User-oriented fares, including free transfer between lines, modes and operators.

Source: Derived (with further development) from Mees, 2000.

to find the best possible practical balance between the two principles. The choice of balance should reflect the major ambitions and objectives for the public transport, as discussed earlier in this chapter.

If the main interest lies in keeping a low level of public finance and other government involvement in public transport development, the strategies indicated by the demand-oriented “Bangkok” model are likely to be useful. If, however, the aim is to develop public transport as a replacement for the car in the development of a sustainable city, the “Zürich” model is the prototype to use as an inspiration.

In small and medium sized cities the coordinated development of one, total system, and not a differentiated bunch of customer-tailored services, will be the only main alternative available for high quality public transport. The reason for this is the small size of the total market and the dispersed pattern of journeys, both in space and time. Coordination and combination of different travel demands is the only way of taking advantage of the economies of scale and the almost universal accessibility that are public transport’s reasons for existence.

1.3 Determine the network structure

Different user requirements will often conflict, and there are limited resources for satisfying them through the provision of public transport services. The design of network structure therefore means solving some important dilemmas and making selective choices. Here is described a network strategy for meeting the challenges that takes account of the fact that the essence of a public transport system is the concentration of passenger flows onto specific lines of movement. Transfer is an inescapable feature of the majority of possible journeys that can be made by public transport. Consequently, how interchanges are designed, and how services are organised and presented, is at the heart of the overall strategy of improving public transport. The practical planning process and tools should support network development through a process of drafting, analysing and redrafting network proposals.

Towards a two-tier network strategy

It is interesting to note that in Swedish public transport planning, there has been a move in planning advice from the demand-oriented towards the supply-oriented model of network development. A planning advice paper by Holmberg, Börjesson and Peterson has been revised to accommodate this change of view within the profession.

They acknowledge that the 1980s idea of tailoring the services to different groups of users at different times of the day has stimulated the market orientation of public transport planning. But taken too far, the principle leads to a complicated service supply and inefficient use of the total resources for the public transport system.

At the end of the 1990s a different strategy had become very clear, which now can be found in planning advice from other countries as well. This implies the development of a two-tier system of urban public transport networks. We have found support for this principle in evidence from city examples mentioned later in the guide. Therefore, this guide follows the same strategy.

The first level is the development of heavy trunk line services with high frequencies, priority measures and heavy demand. This requires the concentration of routes and often somewhat longer distances between stops than traditional bus services. All main transport corridors should be served by a combination of urban and regional trunk lines. They should be seen as a permanent element of urban structure and therefore run with a high standard of service at all operating times.

The second level of service must serve the rest of the city and region with a more flexible and dispersed form of operations that will provide improved public transport access also for elderly and disabled persons. Often minibuses are used and operations vary from traditional line haul traffic with medium to low frequency to demand responsive services, even using taxis.

A major task in network development is to find the right balance between the two types of services, in space and time. A second challenge is to integrate the two levels of the network into a single public transport network that cater for the different demands of the various groups of users.

Integration of all lines and modes should be achieved through the development of high quality interchanges located at nodes in the urban structure. Co-ordinated scheduling, ticketing, traffic control and information systems will ensure that the public is offered seamless public transport between all parts of the region.

Mapping the network structure

The basic working tool for public transport network planning is a map of the geographical area under study. The level of detail in the network map will vary according to the planning task. For the planning process, and the later information about public transport services for the users, it is important that it is possible to follow each line on the map, their stopping places and the opportunities for change between lines. It is also crucial that the level of service frequency is indicated. Many current network maps give the impression of a very extensive public

transport network by including very low frequency and specialized, limited service lines, although these lines are of little interest to a large majority of users most of the time.

One starting point of network planning should therefore be to make a detailed analysis of the network by drawing up a map of all the lines that service the area under consideration, and putting down the information about the service frequencies for all the lines. The process of analysing the network services will often reveal a number of facts that might not be so evidently clear at the start. You are likely to “discover” line and route sections that offer little in terms of travel opportunities, due to low frequencies, detours, one-way operations, alternating routes, departure schedules that are uncoordinated, barriers to walking to and from bus stops and stations, etc. This implies that the public transport system’s coverage of the urban area might be of a much lower quality than what might be judged at first glance.

In addition to the general coverage indicated by the combination of frequency and walking distance, you must obviously also check the line pattern and journey times between different areas and origins and destinations in the region. Are there direct connections between important areas of strong travel demand? Do the lines follow direct and short routes, or do they try to cover virtually all market segments on the way, and by this make the longer journeys so slow and uncomfortable that only captive riders will use the lines?

There are computer programs and data sources that can assist you analysing the public transport network. But you will normally find that the geographical map, on paper or on a computer screen, is a most useful tool. In the chapters on network design we therefore emphasise the geographical and physical aspects of the system, rather than the technical and other issues that are important for urban public transport systems.

Dealing with the challenge of weak demand for public transport

Designing a public transport network in order to

Two different approaches to network design

The Tailor-made approach



A dense, normal frequency network most of the day

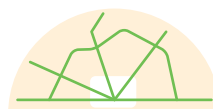

Reduced and low frequency network on holidays

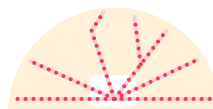

Express lines in peak periods

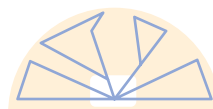

Evening and night lines



Service lines for the elderly and disabled

The Ready-made approach

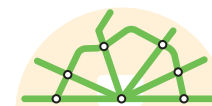

A basic high frequency network most of the day

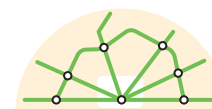

Same network, reduced frequencies on holidays



Same network, higher frequencies in peak periods

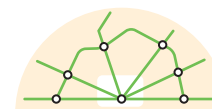

Same network, reduced frequencies evenings and nights



Local lines and demand-responsive services for all users

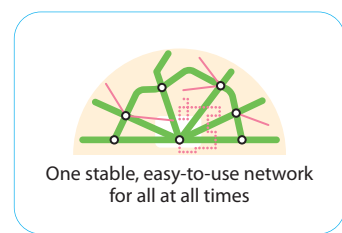

One stable, easy-to-use network for all at all times

A public transport network might be tailored to fit different groups of users at different times, but seamless public transport for all users is most easily achieved by the Ready-made approach.

 **GOOD PRACTICE**

Mapping the existing network

A case study of the bus network in Kristiansand, Norway, illustrates how a common form of presentation of the public transport network is unsuited for planning purposes. However, by combining the network map with information from the published timetables of lines, a more useful analysis can be made.

1 All road sections where buses run are shown on the line map for the buses in Kristiansand that is used for the presentation of the system to the public. The first problem with this presentation is the difficulty of following the individual lines and their routes on the map, and even knowing where the buses stop. This can be improved by putting more line numbers on the map and drawing indicators for the stops. Naming the stops would further increase the information value of the map.

The second problem is more serious. This is the lack of information about the frequencies of services. Obviously, to the user it is crucial to know whether the bus service runs every 15 minutes or just a few times per day. This map does not distinguish between such very large differences in service, so the line map may be very misleading. It is difficult to solve this problem without making the map too confusing.

When used for planning purposes, the simple network map might lead to misleading conclusions concerning the level of public transport service in relation to land use planning in the area. The map may be used to indicate that most of the urban area is well covered by public transport. The conclusion could be "here we can build more, because the site is well covered by an existing bus line." But

since the map says nothing about service frequencies, it cannot tell the planner anything about how well public transport might compete with the car.

2 A better basis for network planning can be made by combining the information from the conventional network map with the information in the timetables for all the lines. Create a simple sketch map on the principle of "every bus line a separate pencil line" by the use of old fashioned colour pencils to combine the information from the network map and the timetables. Indicate, by the lines, the frequencies in different representative time periods. Soon you have an important, basic tool for network planning. And you can start the analysis of how well the system serves the urban area.

3 During your network analysis you are likely find some central sections of the network that have a high, "forget the timetable" frequency. You will also find sections of the network where the frequency is too low to make the bus competitive with the car. You might find one-way sections that reduce the frequency and create detours for some of the customers. You might find sections on the middle of a line where the buses run on different roads in each direction, or where departures alternate between different routes. You might also look more into the details of the departure times, perhaps discovering that some buses depart or arrive at the same time, or at very uneven intervals. This latter point is important, because it may significantly reduce the value to the customers of many buses along the same route. This investigation of the public transport service will give you the chance to define the sections of the bus

network where the buses offer a true high frequency service, which is a prerequisite for competitiveness with the private car. The result will be that a much smaller part of the initially presented bus network can have a significant effect on transport demand, as indicated by the map of high frequency sections of the network.

After the analysis of the services offered, you can redraw your map of the urban area that is well covered by public transport. You might then also take account of barriers such as rivers, railway lines or highways, and barriers for people walking to the bus stops, such as steep cliffs. You may also differentiate the network and its catchment area between two frequency levels, as indicated in this revised map of the urban area. Now you have a map suited for the discussion of site development in relation to the public transport system. And you can start finding possible improvements of service that might be of interest for the future.

Source: Lange et al. 2002.



1

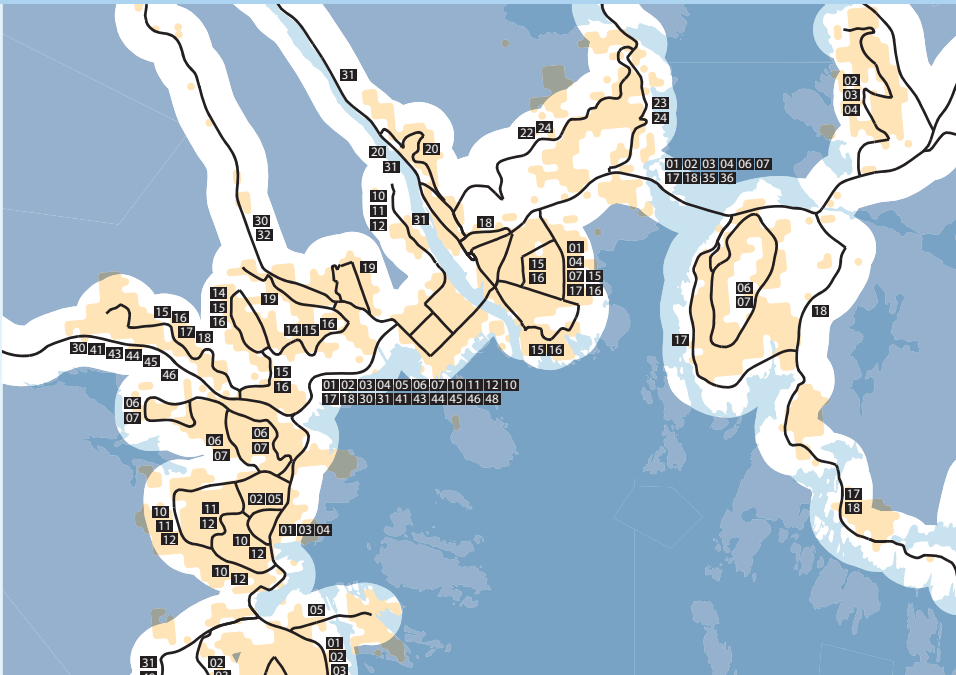

3

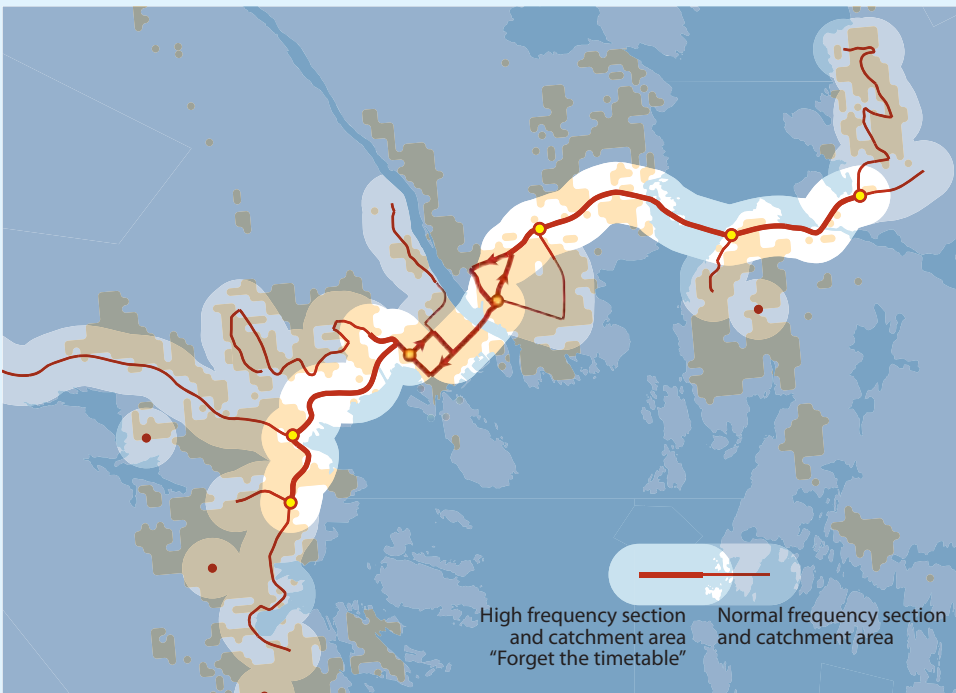

Comparing the two paradigms of "The Seamless Journey" and "Barriers to transfer"

The Seamless Journey	Barriers to transfer
Comprehensive connectedness; the public transport network offers an 'anywhere-to-anywhere' service.	The need to transfer is a significant disadvantage for any public transport journey for which there is no direct connection.
Full advantage can be taken of journey time savings that are offered by a change to a faster mode.	Passengers will stay on slow, direct services and will not transfer onto faster modes.
Planners/operators can have maximum flexibility to match demand and supply, and maximise the overall efficiency of the network through appropriate mixing of modes and services.	Sub-optimal network solutions are adopted to avoid imposing additional transfer on passengers.

Source: Tarzis and Last, 2000

create a competitive, high quality system means finding answers to some important dilemmas. Some of the recommended principles (in chapter 3) are in conflict, and sometimes the local circumstances may require adjustments to the main principles.

One challenge concerns the level of demand for public transport. The smaller the city, and the less densely it has been built, the harder it is to provide the high frequency services needed to create a public transport network that can be a competitive alternative to the car. Also lack of parking regulations and fees or other restrictions on car use make the competition harder. Under these circumstances, the recommended alternative to the high frequency network is the integrated pulse timetable where different modes and lines are coordinated through a common schedule and network interchanges.

In all types of areas a certain level of coordination and integration of services through network planning is necessary for efficient allocation of operational resources and the creation of simple, user-friendly systems of travel. From this point of view, integration, attractive solutions and efficient use of resources are more important in small towns and areas with a low level of public transport patronage, than in larger cities and urban regions.

The key role of transfers and interchange points must be recognised

A second challenge is associated with the choice between satisfying the customers' ideal demand for direct travel, and the need to concentrate operational resources to achieve the economy of scale that creates most of the benefits of public transport compared with the car.

This point has been stressed by the GUIDE project (Tarzis and Last 2000). They ascertained that transfer between services is an inescapable feature of public transport. The essence of a public transport system is the concentration of passenger flows onto specific lines of movement; it is almost inevitable that the network of individual lines – bus routes or rail services – will not serve all combinations of passenger origin and destination.

Ideally, the public transport network would offer fast, direct links from everywhere to everywhere, just as the car does for those who have this option. But in practice, public transport works by concentrating passengers onto selected corridors, and inevitably this leaves some journeys without a direct connection. So transfer is a necessary evil when it comes to providing comprehensive linkages within an urban area.

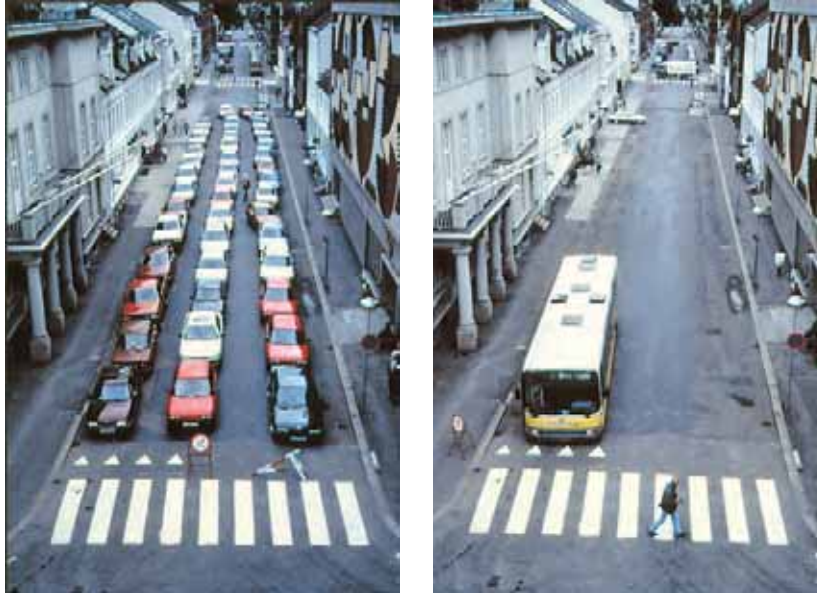

45 people on the move individually (left) and together (right). One basic idea of public transport is to induce people to travel together in vehicle units that are more space efficient than the motorcar. The intrinsic need for transfers in public transport networks follows from this basic idea of many people travelling together in bigger vehicle units rather than individually and directly door-to-door. PHOTO: SVEIN MAGNE FREDRIKSEN

However, there is a range of public transport modes, each of which offers a different combination of characteristics such as speed, capacity, ride quality, ability to penetrate different types of areas, and cost. It can be highly advantageous to passengers to substitute a fast mode (such as rail) for part of their journey, instead of a slow mode (such as bus). Indeed, only by doing so will public transport offer an acceptable alternative to the private car.

Data gathered by Tarzis and Last (2000) suggest that there is some association of higher levels of transfer with higher public transport modal shares. Reducing barriers to transfer will enable individual passengers to gain more benefit from the public transport system, and will increase the attractiveness of the public transport 'offer' relative to the car.

Transfer is an inescapable feature of the majority of possible journeys that can be made through the public transport network. Consequently, how interchanges are designed and presented, and the processes through which passenger expectations are (a) moulded and (b) satisfied, is at the heart of the overall strategy of improving the public transport offer.

According to Tarzis and Last (2000) the key benefits from the systematic improvements of interchanges are:

- ▶ Reductions in disutility from reducing unpleasantness of individual interchange experiences of existing users.
- ▶ Reduced journey times from rerouting where previously interchanges discouraged use.

- ▶ Fulfilling a necessary condition to make possible an increase in public transport mode share, especially where it is traditionally least competitive such as for orbital movements.
- ▶ Reduced pressure on crowded radial sections.
- ▶ Increased flexibility for operators and planners to offer a mix of public transport modes to suit local circumstances.

Connect to the inter-regional transport network

Keller et al (2000) addressed the inter-connection of long distance transport networks with local and regional networks of all modes and reviewed best practice in EU countries and five case study cities. Some of their main conclusions about public transport interchanges should be noted.

They concluded that there is “enormous room” for improvement of the interchanges between local/regional and national, long distance public transport in Europe, concerning all aspects from location and financing to design and operation. The location of major interchanges has far reaching long-term consequences, and transport planners should closely co-operate with regional planners on this issue. An important challenge is to regain revenues from rising land prices and economic growth stimulated by a major interchange.

The design of such interchanges is also a multi-disciplinary task. Copying best practice could be very valuable in some cases, but often it would be more useful to have a consistent system within the city region. The most important issues of physical design are:

- ▶ Walking distances should be as short as possible when changing vehicles.
- ▶ Elevators and escalators are required for comfort and speed when a change of level is required.
- ▶ Visibility between main destinations inside the interchange improves orientation and safety.
- ▶ The accessibility needs of disabled and elderly persons (and passengers with luggage, prams etc) should be a prime concern.

- ▶ Weather protection, natural and artificial light and cleanliness and good maintenance are important factors for the users’ feeling of comfort and safety.

Smooth and integrated operation of services is just as important (perhaps more so) than proper physical design and layout. There is strong evidence that short transfer and waiting times are crucial for passenger satisfaction with an interchange. Linked schedules and short waiting times are more important to travellers than generous services and shopping facilities. Seamless travel requires harmonised schedules of all modes, through ticketing, flexible and multimodal handling of system interruptions.

Telematics are important in improving the inter-connection of transport operations, management and information services, but they should not be seen as solutions in their own right. First, one should get the transport system right, including prices. Second, one should get the infrastructure right, and only then get the telematics right. Then information reliability is the key to success. Information must be accurate and believed by the customers, so that they are able to act on the information.

To provide seamless travel to the customer, according to Keller et al (2000), it is necessary to have strong regulation (legislation), forcing all transport operators to closely cooperate. Also the financing of interchanges is a cardinal question. Having a public authority owning all infrastructure and private operators paying for their use leaves flexibility in operations and control over the quality of the infrastructure.

Define the main network that is wanted in the long term

Finding the best possible solutions in a particular city and its surrounding district will always be a practical planning task. Best practice must always be developed through a combination of sound theory and good principles based on research and reasoning, and local information, understanding and good judgement.

It is good practice to make a thorough analysis of the market and the public transport development strategy every 4–5 years as part of the regular regional transport and land use planning process that is quite common in the Northern European Countries. This process should lead to a recommended long term network strategy plan. This can serve as a guide for medium and short term development of the public transport system, as well as a framework for land use and transport measures.

To create such a long-term network plan, the following pragmatic approach is suggested:

- ▶ Find the main corridors of transport demand in the region; today and in the future.
 - ▶ Analyse and predict demand volumes in order to define the capacity needs and the possible alternative modes and service levels that might be considered in the different corridors and travel routes and sections.
 - ▶ Analyse existing rail infrastructure and its possible future capacity.
 - ▶ Evaluate the possibilities of market development, new urban development and service improvements being able to lift existing public transport demand to a level that might merit the use of a rail-based system on certain sections of the network.
 - ▶ Consider also an upgraded bus system in the same corridors, and on other sections of significant future demand.
 - ▶ Study how regional and local services may most efficiently be differentiated and integrated.
 - ▶ Draw up sketches of the total network with different groups of lines on all modes available, and try to cover all main origin-destinations with as few, and as direct lines as possible.
 - ▶ Draw up local feeder lines and non-radial, cross-city lines that might have sufficient demand to be part of the main travel network of the region.
 - ▶ On sections and in districts with too little demand to allow for high frequency services, consider developing services with pulse timetables and even demand responsive services where this might give most value for money.
- ▶ Look at the consequences of this preliminary network for terminal and interchange locations, and see if there are any needs for new infrastructure, traffic regulations or other improvements in these places.
 - ▶ Restart the drafting process if this procedure runs into heavy conflicts of interests, or if new ideas have come up during the planning process.



2 The institutional context for network planning

2.1 Understanding the role of planning in different settings _43

- Understand the role of public transport _43
- Recognise the imperfections of the market _43
- Strong or weak market regulation _45
- Four different types of public transport frameworks _47
- Network planning is more important in the public service approach _47
- Combine integrated planning and market competition _50

2.2 Learning from institutional reforms _51

- Limited success of on-the-road competition in the UK _51
- Lack of bus and rail integration in Tyne and Wear _52
- Off-the-road competition is the dominant trend _54
- UK experiences with tendering _54
- Scandinavian experiences with tendering _55
- Limited continental experiences with tendering _56
- Create an organisation fit for dynamic change in an open society _58

2.3 Being aware of the institutional factors behind good practice _60

- Key factors of success and good practice _60
- Push and pull strategies must work together _60
- Lessons from France and Germany on light rail development _63
- Interaction with public policies outside transport _63
- Regional body important for integration _65
- Propensity to fund public transport expenditure _68
- Trends towards off-the-road competition _70
- Gross Cost or Net Price contracts? _71
- Incentive schemes _71
- Multi-modal integration – a key to good network planning _71
- Route or network tenders? _73
- Regulation and co-ordination still good practice _74
- “Soft” public transport measures _74

2.4 Gaining support for public transport development _76

- Deserve trust and show confidence _76
- Understand the role of local politics _76
- Co-operate with local stakeholders _77
- Create alliances with local interest groups _78

What constitutes high quality public transport is defined by the objectives of the decision makers and the institutional regime they are working under. The first section of this chapter gives an overview of the rationale behind the different types of institutional contexts public transport planning must adjust to in the HiTrans cities and elsewhere. The second section takes the institutional context as given, as it is for operational purposes at any one point in time, and sums up research on how the different settings affect network planning and the development of public transport. The last section synthesizes conclusions from studies of barriers and stimulations to the development of successful high quality public transport. This gives a lead for the direction of change that should be followed if and when the institutional structure may be changed.

2.1 Understanding the role of planning in different settings

This section considers public transport service planning in a broad international context. For public transport network planning to be successful, it is necessary to have an understanding of the organisational structure, of the interplay between institutions and the urban transport market, and of the dynamics of the public transport sector.

Understand the role of public transport

In general terms, urban public transport can be treated as being fundamentally a public service or subject to the competitive market (Van der Velde 1999). The objectives of public transport vary between countries and cities. This has very important influence on planning, regulation, tendering, organisation etc.

In the case of the public service approach, public transport is provided on “command” of the relevant authority as a core service to the citizen. In such cases, the public transport service is typically one of many services under the control of the municipality and supported as necessary from the public purse. Usually the operations are carried out by public sector entities, although they may be contracted out. The main point is that only the political authority has the right to determine or to change the offered services.

In the case of the market approach, public transport is considered as an activity that is naturally provided by entities interested in engaging in trade and carrying risk in the pursuit of profit. In some cases the market functions well; there is profit to be made by commercial operators, and the primary interest of the public authority is the regulation of the market in the public interest. In other cases, the market has ceased to function well (for example, due to the services becoming unprofitable) and the public authority has intervened through mechanisms such as planning, direct operation, support financing, and co-ordination in order to meet urban and societal objectives.

The two different perspectives are often reflected in discussions of public transport policy and organisation. In reality, both approaches are mixed, and it is not unusual for the public sector to behave in many

ways as though they were in the public service scenario, even if they want to base the policy on market initiatives. Conversely, the results of the market are often considered unacceptable, so political control is reintroduced by various types of regulatory mechanisms.

Recognise the imperfections of the market

An analysis of the theoretical conditions for a well functioning market shows why one should not rely entirely on the market approach for the development of the public transport network. As is shown later in this chapter, the experiences from attempts to practise free access and market competition on the road, show that this creates inefficient use of resources and complex networks that are very difficult for the public to perceive and use.

The following conclusions may be drawn in relation to the free market approach to urban public transport (Seip 2004):

The market for urban public transport is so special that “truths” about other types of markets should not be taken for granted. In particular, the concept of economies of scale makes the idea of on-the-road competition potentially difficult in practice. For reasons of efficiency – and especially passenger understanding – there is a need to co-ordinate lines and services.

There is a need for economic incentives in certain fields of public transport. But such instruments should be used with care, and only after thorough analysis of the likely effects.

There is a need for several types of services and different modes of transport to cater for various groups of users and journey purposes.

Due to the limited scope for competition in public transport, there is a clear risk that the actors in the market will make a strong effort to secure monopolies instead of concentrating on serving their customers efficiently.

There is a need to create incentives to the operators to make better connections to other lines, operators and modes. Without such incentives, each

Theoretical conditions for efficient competition – examples of real practice

Theoretical requirements	Reality, examples from urban transport
Preconditions for efficient competition	Public transport will always be subject to competition. Usually there are alternative modes of transport, or other destinations, available, with the private motor car as the dominant competitor.
Many or several participants or operators	<p>Experience from both free market on-the-road competition (e.g. in UK outside London) and off-the-road tender competition (e.g. Scandinavia) show that oligarchies of a few strong, often international, companies take over the market. In small markets (and small cities) competition is often weak.</p> <p>On rail systems (particularly single track systems) it is very difficult to achieve real competition between different operators. Competition for franchised monopolies is one possibility.</p>
No market failures in the form of public goods that everybody have access to	The marginal costs of alternative car use seldom reflect the consequences of different mode choices. The transport market in urban areas is characterized by significant market failure, e.g. roads that are free to use, adverse environmental effects.
No external impacts whose costs are not paid for by the actors	In urban areas there are often important indirect effects that the travellers, car user and operators do not have to consider when they make their choices, e.g. congestion, delay or pollution that is forced upon other users of the transport system and surroundings.
No natural economies of scale that encourage monopoly operations	Urban public transport has structural properties with low barriers to entry and the potential for some economies of scale and scope. These benefits are exploited by high capacity lines with large units and trains, and create the need to co-ordinate lines and services that serve different parts of the market with interchanges and with division of work between different modes. The trend to oligarchies is noted above.
Small transaction and administrative costs in order to establish competition	Public transport is supplied in lumps (a bus, a tram) but sold by the seat. The product on offer is really a 'place on' each departure on a line, and it is not possible to auction this offer separately.
The prices must be "right"	
The prices must reflect the marginal cost, i.e. the extra cost of a new user	This requirement is almost impossible to fulfil in practice, since it is difficult to measure cost variations and adjust prices accordingly. By way of example, a new passenger over a critically loaded section of a line in a peak period costs much more than a new passenger travelling a longer distance on a section of the line with many unoccupied places. The introduction of 'off peak' pricing models shows some movement towards the theoretical requirement and, of course, the use of season tickets which give discounts for frequent peak travel can be very deleterious to the use of capacity.
The prices must reflect both direct and indirect costs of the producer and the indirect costs of non-users	The social demand for the inclusion of non-user costs of congestion and pollution creates a need for public charges and taxes, as well as a rationale for subsidy of public transport.
If the revenue from the fares under marginal cost pricing do not cover all costs, other sources of public transport finance must be found	<p>In practice, public transport fares, at least outside peak periods, are normally too high in relation to the marginal social cost of producing the service. Major reasons for this are economies of scale and that the public will not pay for all the social benefits and because the competing car use is not properly priced to cover all costs.</p> <p>Free buses to specific shops are an example of a benefit (higher sales volume in the shop) that the private company (for example, IKEA) is prepared to pay for. This can make the bus service a profitable undertaking.</p>

Source: Based on Seip (2004) and Rothengatter (2000)

operator will sub-optimize the system in order to keep passengers and revenue for itself.

When contracting out services, security against bankruptcy of operators and the maintenance of acceptable quality can be a challenge.

Strong or weak market regulation

The two polar extremes of public service versus the market can be described in terms of different degrees of public regulation. For a specific country, city or urban region various mixes of ownership, access to the market, control over planning and operations, regulation of fares, subsidy levels and systems of financing are in use. The picture is even more complicated by the fact that the institutional settings are not static but are evolving.

In practise the institutional frameworks for urban bus transport are more differentiated than those of urban rail-based transport. Rail-only-based networks in urban areas are rare. In mixed mode urban networks the institutional arrangements for the rail based element have not generally changed as much as for public transport on roads. Rail networks are more likely to be towards the public service approach end of the spectrum since they are expensive to provide and normally require at least some element of public funding.

The ownership of vehicles is generally private in least controlled regimes and public in the most controlled environments. However, in many controlled environments sub-contracting to privately owned operators is common. There are a few instances of semi-publicly owned companies with either a minority private sector shareholding stake or public sector status reduced to that of a minority shareholder (ISOTOPE project, EC 2000).

Non-vehicle infrastructure (excluding depots) is likely to be publicly owned in all environments, with some privately owned infrastructure in the least regulated environments. Quality licensing is imposed to a varying degree in all European market environments, in order to maintain standards of safety for passengers and employees. Fares regulation is present in most environments. The more regulated

environment, the less freedom is left to the operator to change the fare structure.

The nature of access by the operator to the market is highly regulated when the size and location of routes are protected from other operators. Free entry, with no limit to the number of operators per route, describes the least regulated open access situation.

A highly regulated level of planning occurs when routes are allocated (planned) by a public authority, e.g. the national/local government or their appointees. Conversely, routes offered by the operator to be confirmed or acknowledged by the relevant public authority are unplanned events occurring in markets with little regulation. A fixed network of spatially connected routes run by a single operator is found in a highly regulated cities and regions, whereas routes that are licensed individually are typical of less regulated environments. An operator may run several of these single routes as a package.

In highly regulated cities operators will run a service of one or more routes as an historical entitlement. This is typical of former eastern bloc countries. A less regulated alternative is renewable tender whereby an operating contract is subject to regular renewal (the time scale varies between countries), usually by the process of competitive tender.

Lastly, subsidies are flexible and highly regulated if they are paid for by deficit funding, but are least regulated when they are determined in the allocation of route(s), usually by competitive tender.

In practice these characteristics rarely exist in the polar form but can be combined to give rise to a spectrum of different market classifications from absolute public service to absolute free market.

Indeed, different regimes can exist in the same location for different modes, e.g. long-term franchises or public monopoly for rail-based mode, with more competitive market for bus and paratransit. Also, there may be an unofficial or unregulated market for paratransit in parallel to the formal network for conventional public transport vehicles.

Explanation of some key market characteristics of bus services under different degrees of regulation

Characteristic	Market Environment	
	Highly Regulated	Least Regulated
Type of ownership	Public State/local authority ownership of vehicles and infrastructure. Some sub-contracting to private operators.	Private Private ownership of vehicles. Infrastructure likely to be publicly owned.
Quality licensing	Similar standards on for example safety regulations in all market environments.	
Fares regulation	Restrictive Detailed regulations designed to protect passenger interests.	Limited Little fares regulation, e.g. no regulation or prescribed maxima only.
Access by Operator to market	Protection Size and location of routes are protected from other operators	Open Access Free entry with no limit to the number of operators per route.
Level of planning	Planned Routes are allocated by government.	Unplanned Routes are determined by the operator, to be confirmed / acknowledged by the relevant public authority.
Regulatory Mechanism	Fixed group of routes Fixed collection of spatially connected routes, run by one operator.	Single route Routes are licensed individually. Operator may run several routes as a package.
Entitlement	Fixed entitlement Operators have a legal/historical entitlement to route(s).	Renewable tender Operating contract is subject to regular renewal (time scale will vary between countries), usually by the process of competitive tender.
Subsidies	Flexible Amount of subsidy is flexible, being paid by deficit funding.	Fixed Subsidies are determined when routes are allocated, usually by competitive tender.

(Mageean et al 1998)

Four different types of public transport frameworks

Whilst the classification of market type is useful, it mixes the three issues of regulation of the market; market type, market access and means of procurement.

Finn and Nelson (2002) note that in the past decade, there has been a very clear trend towards an open market for the provision of (urban) public transport, characterized by:

- ▶ Restructuring of the institutional frameworks
- ▶ Clear separation of the planning and operational functions
- ▶ Opening of the markets to allow new entrants to offer services
- ▶ Procurement of supported services through market processes
- ▶ The transfer to ‘arms length operation’ of formerly public-sector operating entities – i.e. the re-structuring as companies with separate corporate, governance and accounting principles
- ▶ Privatisation, joint-ventures and other means of modifying the ownership base
- ▶ Making public assets available to both public and private sector bidders
- ▶ Mobilising private investment for public infrastructure and services to create public-private partnerships

Taking these trends into account, it is possible to provide more simple classification of four distinct regulatory and market frameworks:

- ▶ **Public sector entity:** The responsibility for the transport services are vested in a public body which plans and directly operates the services. This is the old-style public sector model, e.g. Vienna.
- ▶ **“Light-touch” regulation:** The transport authority considers applications from operators (of any form of ownership) and grants licences or other permissions, based on relevant criteria, e.g. Finnish regional cities.
- ▶ **“Off-the-road competition”:** The transport authority retains the initiative, and allocates the right to operate and any associated financing through an

evaluation of available interested operators, e.g. Copenhagen, Helsinki and Adelaide.

- ▶ A “deregulated” market: An open market is established in which operators can choose what services to provide, as best suits their core objectives, e.g. Great Britain outside London.

It should be noted that the choice of institutional frameworks can have an influence on production costs. Benal (2003) found in a comparative study that the open market were the cheapest per bus km, the franchise system the most expensive and the regulated market falling in between. There are of course, many factors other than institutional factors, that affect costs of production. Overall viability will depend on the relationship between production costs and revenues from passengers which is not examined in this study.

Network planning is more important in the public service approach

The institutional setting in relation to the transport market defines the degrees of freedom available for network planning. The power of the responsible agency, normally central, regional or local government, will determine the extent to which network planning is possible from an integration, funding and spatial context.

The co-ordination between the various bodies will have an impact on the success of network planning. Clear objectives are identified as fundamental to the optimal functioning of a public transport network and these are linked inextricably to good management techniques (Armstrong 2001, Catling 1995).

The different categories of market environment have distinct consequences for the scope of network planning. For example, a totally free market, although unusual, would give no place for network planning.

A common situation is to have a free market for profitable services with the ability to buy in services not provided by the market. If all services are provided by the market, network planning can still be important because it is the total package that

encourages the use of public transport. Network planning here could include:

- ▶ The provision of passenger information at a number of different levels from static to real-time, from pre-trip to in-trip.
- ▶ The provision of supporting infrastructure in terms of facilities at multi-modal interchanges, single mode stops or stations. Planning should cover issues related to the whole travel and waiting environment with the view of minimising the interchange penalty.
- ▶ The maintenance of appropriate safety level where competition provides a level of service unsuitable for the spatial environment.
- ▶ Broadly identify what is provided so as to ascertain the gaps in service provision.

Public provision is the key to overall network planning where services must fill in gaps provided by the market. Funding constraints will mean that the services provided by public funding will be determined by a set of rules established by the responsible agency. These can vary between the provisions of services. For example:

- ▶ For journeys to work
- ▶ For concessions to elderly, school travel, mobility impaired etc.
- ▶ For other social objectives, e.g. to increase social inclusion.

The degree of network planning will determine the form of public provision. This will normally be a form of tender. The form of the tender will have implications for network planning and this is discussed later in this chapter.

Network planning must consider the degree of integration and co-ordination between those services provided by the market and those which are provided by public provision.

A somewhat different situation occurs with licensed routes allocated to operators with monopoly rights. In this market environment, in contrast to the free market, there is often an obligation for operators to provide marginal services in return for the potential higher return achievable on routes where the

operational security and economic return is inflated by monopoly status.

The network planning role will therefore encompass the services identified as able to be provided by the free market and in addition include taking a view of the extent to which licensed operators are fulfilling their contractual obligations and contributing their monopoly surpluses for the good of public transport provision.

In a franchise market environment, network planning is a clearly defined role of the responsible agency. In addition to the tasks identified for the free market and licensed route environments, the responsible agency must define:

- ▶ The spatial area for each franchise, which can vary from a small part of an urban area to entire region.
- ▶ The level of service to be offered
- ▶ The density of service to be provided
- ▶ The degree of integration, both within and across franchise boundaries.
- ▶ The availability of funding.

These elements substitute for the role of the market. Thus network planning assumes a strategic function as well as covering all the subsidiary issues under all the above sections.

In a public service market environment, network planning takes on a central role and is able to govern the pattern of public transport provision. This is likely to be associated with public ownership, in contrast to the franchise market environment. Financial constraints are not usually so binding and a commitment to social provision of services is prevalent. The network planning agency will be responsible for the full delivery of all public transport links within its spatial boundary.

Network planning in this context is likely to include the provision of services with good value for money so as to show that public money is responsibly used.

This market environment does not suffer from the artificial boundaries introduced by franchising, nor by the need to include the private profit requirements of private operators in the budgetary

Overview of the advantages and disadvantages of market competition and integrated planning

	Advantages	Disadvantages
<p>Market competition</p> <p>Not a goal in itself, but a means to achieve some other benefits</p>	<p>Can result in better service to the market, in accordance with the demand.</p> <p>Efficiency in the production of services due to the competition between operators.</p> <p>More focus on the development of new products and services.</p>	<p>Is likely to result in large differences in service levels between areas and corridors: A concentration of services to strong, well established markets to/from the city centre, where the competition from the car is weakest, due to congestion, few and restricted parking places etc. Weak coverage by public transport in large areas with heavy car use.</p> <p>Many operators in the same market often lead to complex and almost incomprehensible network of lines and services.</p> <p>May lead to proprietary information and ticketing systems and strongly segmented marketing and branding, even to the extent that users pay more for the service than they have to.</p> <p>Excess capacity and overproduction as a result of several parallel services, without taking advantage of economies of scale, with low profitability as a consequence.</p> <p>The flexibility and market adjustments lead to a less stable service that weakens the basis for the development of heavy infrastructure.</p>
<p>Co-ordinated planning</p>	<p>It is possible to develop an integrated network as a full, attractive and understandable travel alternative to car use.</p> <p>May exploit economies of scale when designing an integrated network, in the scheduling of routes and in the choice between different means of public transport.</p> <p>Can form the basis for long term planning of infrastructure and land use.</p>	<p>There is a risk of developing an inefficient monopoly of planning with weak market orientation and too little focus on efficient operations and service product development. There is also the possibility of ignoring the transfer penalty perceived by passengers.</p> <p>May create a system with inherent cross subsidy so that it is difficult to identify which routes are viable in their own right.</p>

framework (as in all of the other market environments). Thus network planning is to be carried out at a strategic and practical level and will include all the actions outlined above.

- ▶ The transaction costs are often significant when using economic incentives in urban transport. Therefore Rothengatter recommends simple, pragmatic solutions in preference to more ideal solutions according to economic theory.

Combine integrated planning and market competition

The major institutional challenge for creating success in urban public transport is to combine the benefits of market competition and tendering in relation to market orientation and efficient service production, with the benefits of service co-ordination, network integration and the potential of public transport's economies of scale. At the same time the challenge is to avoid the negative aspects of the two principal solutions.

Rothengatter (2000) has expressed the following viewpoints on the balancing of the two principles of competition and co-ordination:

- ▶ In order to succeed in the urban transport market, the public transport system must offer a network of lines that ideally integrates all modes and lines for both intra-urban and inter-regional travel.
- ▶ Lines and their stopping places, timetables, fares and ticketing systems and information systems must be integrated to form a single, understandable, user friendly and efficient system.
- ▶ In order to exploit the synergy effects of a transport network, one has to have a single, strong regional body to co-ordinate all actors in the system.
- ▶ Competition for the operations of the network can be achieved by two different approaches; often a middle way is used in practice:
- ▶ Separate tenders for small parts of the network, even single lines. This will make it possible for many small operators to compete for the market.
- ▶ Large sections, or even the whole network in the region, are put out for tender. Then the operator must do all the work of coordinating lines in the network, in addition to the task of operating the lines. This alternative tends to exclude small operators, and thus reduces competition.

2.2 Learning from institutional reforms

A review of public transport markets around the world shows some clear trends emerging. In both the developed and the developing economies, there has been a greater role for the private sector in the provision of urban transport services, although the motivation for doing so may differ greatly. The transport authorities have typically retained the initiative for the planning of the network, integration of services, and specifying the quality of the transport product. There has been a very wide range of options for specifying services. To illustrate the experiences from institutional reforms and the implications for public transport network planning, the cases of “on” and “off” road competition are explored.

Limited success of on-the-road competition in the UK

On-the-road competition has been implemented in a number of urban bus environments, most notably in the UK and South America, but the initial heavy competition has typically been followed by consolidation and a reduction of innovation. This has led to authorities re-entering the regulatory framework, at least to ensure the fundamental network, integration and quality of service.

“On-the-road” competition allows operators to compete directly with each other for customers, with or without restrictions. This is the closest that public transport comes to a totally open market. In practice, while open competition exists in the coach and private hire markets, it has been rare in the urban sector in developed countries. Even where the market is deregulated, there are often restrictions imposed in the public interest (such as safety). This section is discussed within the UK context.

Scheduled bus services in the UK outside of London have operated in a deregulated environment since 1986. Operators are free to enter/exit the market through a registration process (no route licence needs to be granted) subject to having an operator’s licence and meeting safety restrictions. This has led to a totally open market with direct competition based on service volume, pricing and quality.

Following deregulation, operating costs and subsidies were initially dramatically reduced, and there was a general reduction in the volume of the passenger market. After a period of intense competition among established and new players of different size and ability, the market has settled (White, 1997). This period of consolidation has been associated with the emergence of the five large private companies that dominate the entire UK market. However each of these generally does not try to compete in the others’ recognised operating areas and there are few direct competitive battles.

Until now, the Transport Authorities and their Passenger Transport Executives (PTEs) in the larger conurbations of the UK have only been allowed to intervene in the market by providing financial support for routes (or unprofitable times on commercial routes) which is considered necessary but not offered by the market. This means that the instruments of network development and integration have not been available to the PTEs, and many commentators argue that the market has failed to provide a quality service. The resulting trends in patronage for the PTEs have been worse than for London, where open competition is not permitted.

In October 2001, the UK Government granted powers to local authorities to specify quality standards for local bus services (e.g. via Quality Contracts) and to take remedial action to contract out bus services that have failed to deliver (DETR 2000). The Transport Act (2000) also empowers local authorities and private bus companies to work together via public private partnerships to deliver services according to agreed quality standards. It would appear that these powers are available as a last resort to local authorities and are not an indication of a return to regulation. In 2004 in the UK, there is an increasing trend for bus operators to enter into non-statutory partnerships with local authorities whereby they commit to investment alongside the local authority as a way of increasing their patronage.

Trends in bus patronage in the UK, 1982=100%

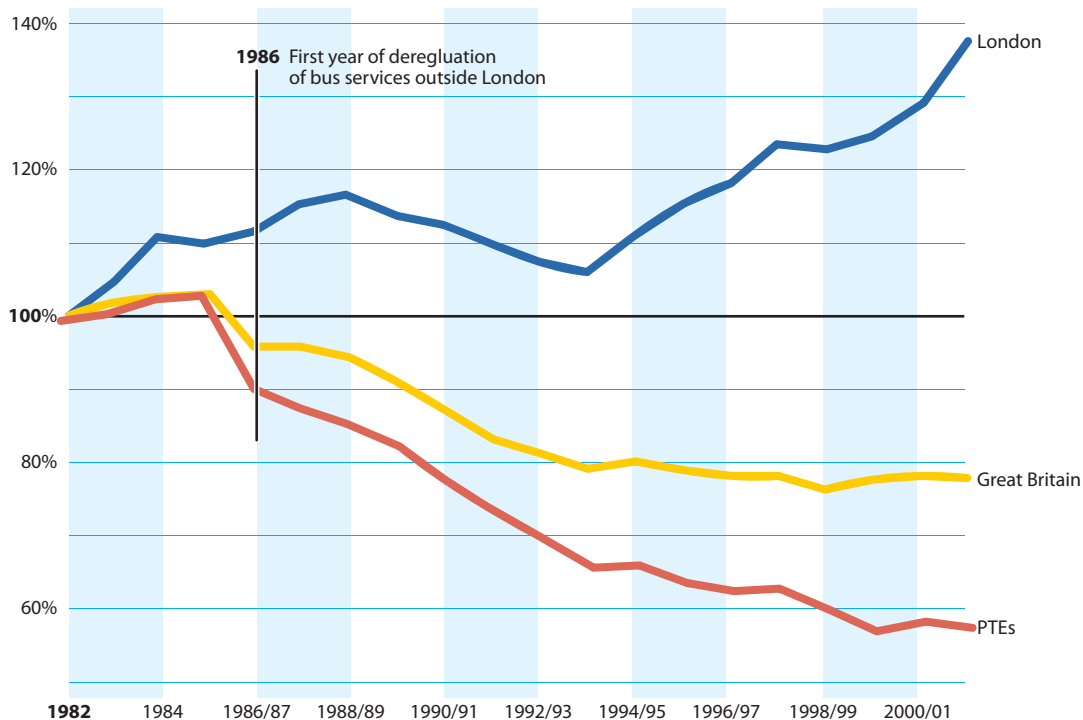

Trends in bus patronage in the UK

The main urban regions of the passenger transport executives outside London, with deregulated bus transport from 1986 compared to the trend in the London region without on the road competition of buses. (Source: PTEG 2003a and b).

Lack of bus and rail integration in Tyne and Wear

Prior to deregulation Tyne and Wear, UK, provided a showcase example of an integrated transport network of bus, Metro and ferry. Some areas not served by the Metro were served by public transport before deregulation of the buses, due to through-ticketing, although others suffered inconvenience from enforced transfer. Since the buses have become less integrated with the Metro, the catchment area of the latter has been effectively reduced to the area within walking distance from the stations. Additionally, competition from buses charging lower fares has hit Metro patronage badly, to the extent that redundancies were necessary.

In the case of the Sunderland Metro extension (opened in 2003), a fall of 12–15% in bus patronage over the area is estimated by the operator to have occurred in the first year. This is a serious loss given the three-way modal split including heavy rail, and it has destabilised the local bus network without generating enough Metro usage to be viable in itself. Duplication of routes between bus and Metro had led to inefficiency, causing losses to both.

From a passenger perspective, the lack of integration of light rail with the bus network is seen as the least attractive aspect of light rail development. In the UK, in contrast to mainland Europe, it is the institutional framework of deregulation and the distinction between commercially operated bus services

Superoutes in Tyne and Wear: An example of partnership in a deregulated institutional environment

The Superoute concept is to deliver frequent, high quality services along key routes. It is created by investing through partnership between bus operators and local authorities to add value to the quality of service and to facilitate transfer between the buses and the Tyne and Wear Metro.

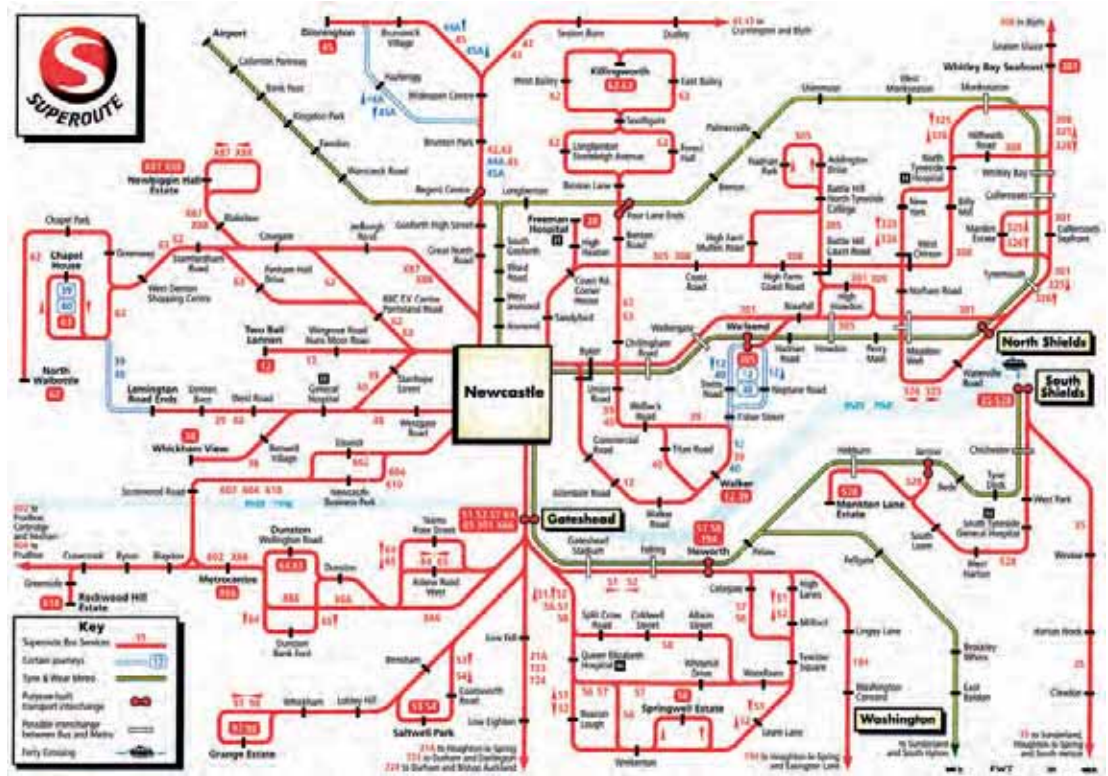

(over which the planning authority have no control) or tendered services (which are provided under the banner of socially desirable services not provided by the market) which prevents further integration (National Audit Office 2004).

However, the greater commercial freedom has been seen as liberating the bus operators who claim that services are now seen to be more financially viable and responsive to passenger demand than was previously the case.

The case of Tyne and Wear allows a number of conclusions to be drawn (Veeneman 2002):

- ▶ The focus on the free market has made it hard for public and private actors to co-operate, leading

to a rather passive public role for the responsible authority in public transport provision.

- ▶ Co-ordination between operators at the level of scheduling becomes focussed on individual market share rather than on collective market coverage.
- ▶ Risk aversion and market control can limit the operators' customer orientation.
- ▶ A free market does not guarantee a competitive bus market.

Off-the-road competition is the dominant trend

Off-the-road competition is by far the dominant form of market participation by the private sector, mostly through competitive tendering and to a lesser extent through negotiated contracts. Competitive tendering has shown that it can achieve the objective of providing a viable public transport network, although this requires good preparation, clarity, commitment, well-developed procedures and appropriate skills. It also requires a sufficient pool of potential competitors who have the incentive both to participate and to continue to deliver quality services in the interest of the consumer.

“Off-the-road” competition is arguably the strongest emerging trend at a European level, giving rise to a greater number of examples. It also offers the greatest complexity from the perspective of the authorities, of organisational frameworks, and of the legal/regulatory frameworks.

Despite the increased workload for the authority, the benefits over on-the-road competition arise from being able to influence (to a greater or lesser degree) the type, quantity and degree of integration of the transport services. At the same time, stability in the provision of the services can be given, and wasteful or destructive competition can be avoided.

Some element of planning is involved as this requires the authority to take the lead in specifying the service attributes, although this can be at the strategic level, leaving the detail to the operators. It is also necessary to establish and implement a mechanism for inviting potential operators and selecting among them, to establish and control the basis on which the services are provided, and to decide how to intervene over time as required.

A wide variety of instruments are available to select the preferred operator. Within Europe, authorities are increasingly required to have transparency in the allocation of both operating rights and public finances. An increasing number of cities are using some form of open competitive process with clear requirements and evaluation procedures. This can be broadly classed as competitive tendering.

UK experiences with tendering

The bus regulatory framework in London, UK, differs from the rest of the country. There is still a very strong regulation, with Transport for London (formerly London Transport) having complete responsibility for the public transport. However, it is still required that the market mechanisms are used to the full.

Thus, a Bus Tendering Unit has been established within London Transport Buses (LTB) to manage the competitive tendering process. This unit fully specifies the services to be provided, as well as all aspects of the operations and support services. The operator has virtually no freedom with regard to the product, but has complete freedom in terms of the means of production (subject to compliance with national labour and other laws) provided that the quality assurance framework is met.

When tendering was introduced in 1987, the original London Bus divisions were in the public sector and retained much of the network, leading to some concerns about whether cross-subsidisation was still being used to frustrate the true competitive process. By the early 1990s, London Buses had been sub-divided into separate corporate entities. These were transferred fully to the private sector so that all services are now provided by the private sector in true competition with each other. Contracts are “gross cost” – in other words, the contractor is paid for the output irrespective of the actual patronage, and all revenue accrues to LTB.

The tendering process in London is almost completely focussed on best-price for a highly specified product, subject to output quality and reliability (Kennedy 1995, Toner 2001). Total costs for bus services in London have been reduced by almost 30 percent in the period 1986–1999, and costs per service kilometre have reduced by 46 percent.

Total patronage in London has increased over the period in contrast to the rest of Great Britain outside of London. This is a result of economic growth in the London region, coupled with a growing policy preference towards public transport as well as the unique role that public transport plays in London vs.

other British cities. Of course, it might also be due to the contracting regime, which is different to the rest of Great Britain.

Scandinavian experiences with tendering

Sweden changed from a regulated market, where operators had a monopoly, to a competitive tendering system in July 1989. Ten years later 80–90 percent of the Swedish bus market was tendered. Most of the bus operations are based on gross cost contracts in which the transport planners are responsible for the design of the network (including timetable and fares), but the operation of services is put out to tender (Carlquist and Johansen 1999).

In the first round of tenders in Stockholm (for about 20 percent of routes) the state-owned Swebus won 79 percent of the operations. In the second round (for another 20 percent of bus routes and two underground lines), the municipal company SL Buses won 98 percent. Between the rounds, SL Buses had undergone significant rationalisation, including some 10 percent wage reductions (although still paying higher wages than private competitors). The Swedish results are no doubt due to the concentration of operators in Sweden and the way in which very small packets or single routes are not put out to tender. Jansson (1996) reports that a substantial cost reduction took place in Sweden in advance of competitive tendering through rationalisation.

In Denmark, tendering was introduced as a tool for privatising Copenhagen Transport (HT, Hovedstadsområdets Trafikselskap), which operated buses in Copenhagen and large parts of Zealand. In 1989 the national parliament passed a bill for the Copenhagen area creating a framework for public transport development in the area. Copenhagen Transport (HT) became the regional transport authority with a number of tasks: Definition of bus services, tendering of services, organisation of marketing and sales, provision of travel information and the integration of ticketing and pricing. Due to regional reorganisation, HT was later replaced by HUR (Hovedstadens Udviklingsråd) with similar public transport functions.

Outside the capital region, 8 of the 11 county councils in Denmark have established companies that carry out the council policies for public transport (Carlquist and Johansen 1999). Traditionally the bus operations have been handled through negotiated contracting, but since 2002 all services must be tendered. In 2004 a large reform of local government in Denmark was decided by the Parliament, which will significantly reduce the number of local authorities (communes) and give them larger responsibilities for local public transport. Also the Copenhagen region will be reorganised once more.

In Norway, the responsibility for local and regional public transport, but not the railway system, is in the hands of the county councils. In 1991 the Transportation Act introduced competitive tendering, but the county councils have had the freedom to choose other contractual forms. In 1999, only 3 percent of route production was operated on contracts obtained through competition (Carlquist and Johansen 1999). But a combination of significant reductions in subsidies due to cuts in the public budget, stronger negotiations and the use of incentive contracts has produced significant cost reductions and improvements in efficiency. The threat of more competitive procedures has had effects without being put into action.

In Finland, restructuring of the bus industry and operations has been somewhat slower than in the rest of Scandinavia. But in the Helsinki region bus operations have been tendered since 1994 (Antilla 2004). During the first five years (1994–99) significant improvements in efficiency were achieved: 25–33 percent cost reduction on regional bus services and 15–20 percent on city bus routes.

But the competition led to the same type of industry restructuring that has been observed in all countries that have introduced competitive tendering for bus operations: many small operators have gone out of business or become sub-contractors to the few big remaining operators. In later years (2001–2003) the tendered costs of bus operations in the Helsinki region have tended to increase again,

from 5 percent up to 20 percent in the worst cases (Antilla 2004).

The conclusion of Carlquist and Johansen (1999) in their study of the effects of tendering in Scandinavia and UK is that the introduction of competition and privatisation has opened “large windows of opportunity” for companies willing and able to invest in the bus industry, nationally and internationally. In Scandinavia, tendering seems to have had a direct cost cutting effect of 10–20 percent per vehicle km. In UK the reported cost reductions have been larger, partly due to a greater acceptance of redundancies and wage cuts. However, comparisons of cost developments over a period are often very dependent on the period chosen for study. For instance, in Norway significant gains in efficiency were achieved through the threat of competition and tendering – before tendering had been put into use.

On the other hand, an important driving force behind the improved efficiency of the public transport production in Norwegian cities in the period 1986–1997, was a significant cut in public subsidies. This led to fare increases, loss of passengers and substantial negative external effects from increased car traffic (Norheim and Carlquist 1999).

Furthermore, tendering has accelerated the restructuring of the bus industry in the UK and Scandinavia, which has changed significantly within a few years. The number of commercial operators in the market has been cut down to a few, large companies, many of them international “giants” compared to the traditional, small scale, local and often public ownership up to the middle of the 1980s or later.

There seems to be a consensus in the industry and among researchers that there is limited potential for further direct cost efficiency in the deregulated and reorganised markets Carlquist and Johansen (1999).

Better practice in Scandinavia and UK (i.e. the HiTrans partners) will in the future be more strongly connected with a clear focus on customer satisfaction (market efficiency as opposed to production efficiency) and political visibility and relevance to social goals.

Veeneman (2002) identifies a number of lessons from the change of organisation from a traditional government-supported service to a public transport authority. These include the observation that operators will often neglect quality aspects of the service not mentioned in the tender and in response to this public transport authorities have introduced quality incentives. However, it is recognised that service evaluation is a huge task. In addition, there are potential problems with the availability of drivers and vehicles for the free entry and exit to the market. There is evidence that drivers do not wish to change companies at the end of a concession and the procurement of vehicles may also take longer than the period of the concession.

Limited Continental experiences with tendering

Carlquist and Johansen (1999) has summarised some aspects of the situation in Continental Europe. In Germany, Europe’s largest market for public transport, the bus market has been strongly regulated. At the beginning of the 21st century competition has been introduced on a very modest scale. However, tendering is growing in parallel with gradual privatisation of municipal bus companies. The national railway system has been reformed (Karl, not dated) through liberalisation (“Bahnstrukturreform” in 1994) and regionalisation (“Regionalisierung” in 1996).

As in most other countries, the German market share of urban public transport in relation to car travel has fallen, although less than in other countries. According to Puscher (1998), the relatively small decline may be attributed to regional co-ordination of public transport services, which has greatly enhanced the quality of public transport in Germany. The regionalisation of the railways is one important aspect of this.

Some pilot tendering schemes of bus services have revealed that there might be a significant potential for improved efficiency of production in German cities. Tendering of 24 different bus lines in Munich in 1996–99 has been reported to have reduced operating costs by 26 percent at the same

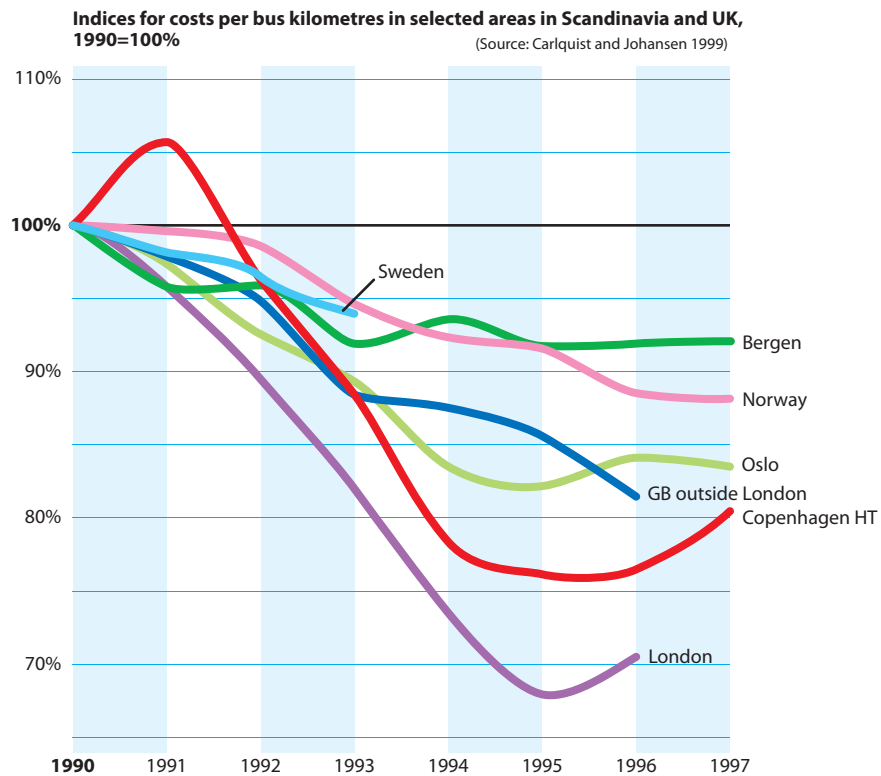

time as service quality has been improved (Wieser 2002).

While competition for local and regional public transport services is as yet limited, public transport must, as elsewhere, always compete with the motor car. A recent study of the contemporary situation in the German local public transport market concludes that there still are “enormous boundaries which hinder an attractive and modern local transport”. Recent European activities aim at further legal and other reforms that will achieve more competitiveness in this market. “But the particular German structures and a decided resistance especially by some local authorities and the majority of the public transport companies against the reforms make it very unlikely to realise the targets in the near future” (Karl, not dated, summary abstract).

In Switzerland a legal reform in 1996 focused on regionalisation at the Canton level the need for a

clearer distinction between the purchasing and the operational functions of public transport. Regionalisation was associated with large cuts in the government subsidies to the national railway company SBB. In Austria, regional organisation was strengthened through an institutional reform in 1999. But still, the statutory prerequisites to ensure effective tendering have not yet been introduced in Austria. Large parts of the transport services are protected against competitive tendering and there are few incentives to improve cost efficiency (Wieser 2002).

In France public transport is under strong governmental control. Still, a substantial part of the market is contracted to large private companies, which may be seen as one of the reasons for the strong French expansion of operations into the international market. ISOTOPE (1998) notes that the French system is based on management contracts with some incentives. It classifies the system as “limited competi-

tion”, but different from the tendering and licensing systems of Scandinavia.

In the Netherlands and Belgium most of the bus market is under public control, with government or municipality-owned companies operating on management contracts. Some commercial companies are operating as subcontractors, and pilot tendering schemes have been introduced. Thus the experience of tendering is still limited, but tendering systems are gradually becoming more common. In the Netherlands, the plan is to reduce the market share of state-operated companies to 40 percent by 2005 (Carlquist and Johansen 1999).

Create an organisation fit for dynamic change in an open society

Experience suggests that in any one country, the institutional context is not static. Examples of change are those in the UK with respect to Quality Contracts and Quality Partnerships, provided under the Transport Act 2000.

New developments bring with them new problems and private finance in the public provision of transport may well lead to institutional compromises over policy. For example, private involvement in the development of a light rail scheme may make it difficult to introduce new policies such as congestion charges, if this may adversely affect the private investor’s return (Jansson 1996).

The changes in the means of planning, procuring, managing and integrating the transport supply, coupled with changes to the regulatory, market and financing instruments – often following big institutional reforms – create new challenges for transport authorities.

Many of these authorities have divested themselves of operating divisions, and have to create new relationships with private operating entities, with associations of operators, and with new public agencies. Activities must be done in a transparent and accountable manner, conforming to procurement regulations. At the same time, the transport authorities have a more visible responsibility to define the service provided and the service quality in terms

of the needs of the citizens, and to assure that the operators who are either sub-contracted or awarded franchises/licences can deliver a safe, reliable and appropriate service.

A Dutch study of public transport organisation and management has looked at the experiences in four different European urban regions; Zürich, Tyne and Wear, Copenhagen and South Limburg (the Maastricht region) in the Netherlands (Veeneman 2002). As a generalisation, the study concluded that there are five different types of rationalities behind the institutional frameworks and organisational reform in urban and regional public transport:

- ▶ “Conceive the customer”
- ▶ “Manage the market”
- ▶ “Schedule the service”
- ▶ “Produce the policy”
- ▶ “Maintain the metropolis”

The rationales represent different professions that may contribute to public transport development but also the issues that dominate discussions of organisational questions.

The organisational challenges of public transport will be most efficiently and appropriately dealt with if the organisation is able to include all five different professional perspectives in the organisational set-up and in the daily business of running and developing the public transport system. Single-perspective organisational reforms are unlikely to succeed in the creation of high quality public transport.

2.3 Being aware of the institutional factors behind good practice

Different cities have different levels of perceived and actual problems with their current modal split between public and private transport, but they share a desire to lower the proportion of urban trips undertaken by private car. The motivation for their efforts to provide good quality urban public transport is not only to provide a 'better' service for existing travellers but also additionally to trigger modal shift away from private transport. The following sections describe institutional and policy factors that influence the likelihood of success in the development of a competitive, high quality public transport service.

Key factors of success and good practice

Overcoming institutional and organisational barriers has, for some time, been recognised as one of the biggest challenges to the implementation of sustainable urban travel (see for example a study of 154 cities by ECMT (2002)). There is much literature on the institutional context of the planning and operation of urban public transport (Denant-Boemont and Mills 1999, Davis and Leach 1991, Gwilliam, Kumar and Meakin 1999, Regional Environment Centre 1999, Colin Buchanan and Partners 2003, Vigar et al 1999). This section addresses the elements of success in the empirical studies of cities exhibiting 'good practice' in their delivery of public transport.

A study of best practice in predominantly European cities (Colin Buchanan and Partners 2003) identifies a number of key points for better practice.

A combination of policy measures is necessary in order to secure overall transport policy objectives. Public transport network improvement must be seen in the context of the propensity to invest in infrastructure or public subsidy and the existence of integrated fares and ticketing. And public transport policy must be coordinated with and supported by other transport policy and planning measures.

Better practice seems to be more likely when a regional body exists as part of the structure to manage transport matters (although this is likely to be linked to other factors discussed below).

Irrespective of the nature of the operation of the public transport in terms of its competitive orientation, a number of key factors emerge. Empirical evidence suggests that good practice seems to have four interrelated factors in common. These are:

- ▶ **Regional organisation:** The existence of some kind of regional structure is the element that many authors have argued as essential.
- ▶ **Funding:** A willingness to commit funds to both operations and infrastructure by relevant stakeholders is a pre-requisite and by itself would appear to be able to generate public transport patronage, but not modal shift from car.
- ▶ **Supporting policy:** Complementary policies that reinforce the underlying transport policies in their achievement of modal shift.
- ▶ **Land use and transport co-ordination:** Successful co-ordination between land-use policies and transport policies in recognition of their conjoint spatial attributes.

These issues are discussed in more depth in the following sections.

Push and pull strategies must work together

The HiTrans Partner Study (2004) results confirm the findings of a number of empirical studies (Van der Maas (1998), Colin Buchanan and Partners (2003, July), Denant-Boemont and Mills (1999)) that transport policy objectives are similar in all cities that have been examined. The objectives that occur most often (in no particular order of importance) are:

- ▶ Reduce car use in order to moderate congestion and reduce the environmental impact of car traffic
- ▶ Increase public transport use
- ▶ Increase social inclusion
- ▶ Increase cycling
- ▶ Increase walking
- ▶ Reduce journey times for all modes
- ▶ Reduce journey times for sustainable transport modes
- ▶ Reduce accidents
- ▶ Reduce total person kilometres
- ▶ Increase accessibility for the mobility impaired

A summary of success factors in the provision of transport services in 11 cities

Of a total of 20 cities, Madrid, Barcelona, Jönköping/Sundsvall, Berlin-Brandenburg, Copenhagen, Helsinki, Stockholm, London, Munich, Zürich and Vancouver were considered to exhibit good practice in sustainable transport policy. The total number of success factors mentioned by officials and planners interviewed was calculated by identifying each factor as “very important” (a score of 3), “moderately important” (a score of 2), “slightly important” (a score of 1) and “working against success” (a score of -2) and adding over all cities. This is a crude measurement of success since each factor is weighted equally for each city, but it identifies a number of key points for better practice.

Success Factors	Total score
Structural or political factors	
Existence of a regional body	28
Existence of political consensus	9
Existence of public support	9
Existence of a political ‘champion’	7
Existence of central government ‘steer’	4
Existence of stable policy delivery	10
Transport policies important in achieving overall objectives	
Investment in infrastructure or subsidy	29
Existence of tendering of operations	19
Existence of parking restraint policy	9
Integration of land-use and transport policy	16
Existence of low public transport fares	13
Existence of integrated ticketing	32

Source: Adapted from Colin Buchanan and Partners (2003)

- ▶ Increase transport affordability
- ▶ Increase economic development and participation in the labour market
- ▶ Improve air quality.

In practice, measures to restrain car traffic are seldom (at least by politicians) considered as an important complementary means to the promotion of public transport. In some cases one can even identify a willingly supported competition between the policy lines of road capacity expansion and public transport improvement.

However one may conclude from looking at those public transport projects that have a high return on investment, that a push and pull policy that favours public transport whilst grasping the nettle of restriction of car traffic, can be of great utility. Indeed, Colin Buchanan and Partners (2003) note that where mode shift is sought parking restraint and road space reallocation are required.

The EC-funded TRANSECON project has explored the long-term impacts of investment in major public transport. The overall objective of the project was to provide definitive evidence regarding the social and economic impacts of urban transport investments and policies in a European-wide context. The project linked information from 13 case studies, covering a range of city and intervention types in terms of geographical distribution, city size, transport policies and investments.

The TRANSECON case studies were: Athens Metro, Bratislava Tram and Trolleybus Extensions, Brussels Metro Line 2, Delft Bicycle Network, Helsinki Subway, Lyon Metro Line D, Madrid Metro Line 6, Manchester Metrolink, Stuttgart–Singen–Switzerland corridor, Tyne and Wear Metro, Valencia Tram and Light Rail, Vienna Underground Line U3 and the Zurich S-bahn. By drawing on existing data supplemented by stakeholder interviews in the study cities, the project has yielded much useful information about the provision of high quality public transport in urban areas.

In the Zürich Canton case study, for example, it was observed that voters for many decades have refused to give approval to heavy road investment; the Canton government has thus had to concentrate on

Barriers to the wider light rail take up in the UK

Poor financial performance	This discourages interest in supporting new schemes and the overall viability of potential schemes is declining as a result.
Raising the capital	Local authorities are concerned about securing funds so as to promote a new system and pay for its construction.
Time Lags	A long period of time is taken to secure the necessary legal powers (through Parliament) to allow local authorities to run light rail schemes and this has a detrimental effect on funding opportunities and decisions.
Insufficient experience in design and planning	Local authorities do not have the experience in their staff to develop new schemes and the investment in such staff is hindered by uncertainties in funding. This is not helped by a lack of commitment from the Department of Transport in terms of funding.

(National Audit Office 2004)

the S-Bahn project in order to maintain a good level of mobility. In Lyon policy-makers felt that better levels of public transport services allow the progressive renewal of the infrastructure for cars.

The transport operator of Valencia blamed the local traffic authorities for not having taken traffic control measures to improve the tram service. The programming of traffic signals favoured private car traffic and prevented the tram from reaching higher speeds and achieving a more regular and better service. In Bratislava there is, for the time being, no political scope for a car restraint policy to support the use of public transport.

In Helsinki one can discern polarised arguments between parties who defend the cause of the metro project and those in favour of widening highways. The metro project was mainly advocated by the socialists, supported by the less wealthy parts of the Helsinki population living in the area of the metro project. This contrasts with the example of Zürich however, where road investment projects have repeatedly been turned down by popular vote. Public

acceptance of car traffic restraint, high parking costs and very high levels of public transport priority characterise the situation in Zürich (Veeneman 2002).

In Delft, it was important that the cycle network project was not seen to be linked with car restraint measures in its planning stage. Experience in The Hague had shown that impeding car access could cause political difficulties, and this was avoided. In Delft efforts were made to convince the public that car traffic would not suffer; otherwise motorists and other groups such as local businesses might have been antagonised, as occurred in The Hague. One point worthy of mention is the consultation process carried out as part of the planning stage; this avoided potential conflicts at the implementation stage. Particular care was taken not to upset the motorists' lobby, although the greater respect generally given to cyclists by other road users in Delft may have been a positive factor in this. It is also worth mentioning the cultural aspect of this; a positive attitude towards bicycles was identified in Delft which could have been important in gaining acceptance for other, non-related, car restraint measures. The new cycle network may be a factor in this; it was said that an effect of it was to put the bicycle "between the ears" of civil servants. This may not be the case in other countries with less sympathy towards non-motorised modes.

Less good practice occurs where there is no integrated transport policy to assist public transport priority.

Better practice in the delivery of transport policy tends to be associated with periods of stability in their policy and delivery – typically policies have been in place for at least 20 years. In turn this implies an extended period of political stability or, at the very least, a degree of political consensus in the approach to transport policy which does not change when there is a change of political masters.

Better practice is found when a range of policies are implemented which use push-pull measures to increase the usage and share for public transport. This means policies designed to push away from

private cars and pull towards public transport. Zürich is a good example of good practice in this context.

Better practice is to have a strong public transport policy complementary with policies to restrain parking policies to restrict the road space allocation to private cars by dedicating space to cyclists, public transport and pedestrians. Evidence is limited, but cities that have been successful in achieving a higher modal split for public transport (for example Zürich, Stockholm and Munich) have combined public transport improvements with car traffic regulation and parking restraint. Oxford (UK) is another example of a city which has promoted a “balanced” transport policy of public transport promotion and traffic restraint – even in the context of deregulation and privatisation.

Better practice in achieving modal shift towards public transport comes from strong links between the land-use and transport policies. Whilst modal shift towards public transport is, in the pursuit of good practice, a desirable objective, it is likely that increasing ridership on public transport is more achievable than either reducing car traffic or reducing the modal share of private cars.

Lessons from France and Germany on light rail development

The experiences of France and Germany highlight three issues where continental experience is very different from that of the UK (National Audit Office 2004). These are:

- ▶ Design feature differences
- ▶ Revenue differences and
- ▶ Patronage differences.

In terms of design features, light rail outside the UK is typically segregated and given priority over other forms of traffic, particularly at junctions. Light rail systems form an integral part of the public transport system so that all public transport modes are integrated. In new systems in France, the provision of the infrastructure is associated with an upgrade of all streets used by the light rail so that the environment associated with the new system is enhanced.

UK light rail systems have not been successful in meeting the targets for revenue that were part of their investment evaluation. This is partly due to a shortfall in predicted patronage but also because UK systems have had economies in construction imposed as a way of ensuring that new systems keep within their original budgets. Two particular economies identified by the Audit Office Report (2004) are the low provision (or absence in some cases) of park and ride schemes, which have affected patronage; and the lack of CCTV/security at stations, which has hindered the enforcement of fares.

Light rail in mainland Europe tend to have highly subsidised fares in contrast to the UK where light rail systems are assumed to require no operating subsidy. Perhaps more importantly, light rail systems in the UK are competing for their traffic from a much smaller public transport pool of demand. This is partly due to the way in which European cities tend to have higher population densities close to the city centres and light rail stations. The patronage pool is also affected by the quality of service and the European systems typically have more stations and more vehicles than their UK counterparts. Finally, in terms of the increased patronage pool, the European systems are normally planned to connect centres of social and economic activity whereas the tendency in the UK is to utilise disused railway lines which may be more remote from where traffic can be generated.

Interaction with public policies outside transport

It is obvious that the effectiveness and efficiency of public transport is dependent not only on the relationships governing the operational control of the public transport agencies but also on developments outside these organisations. The impact on good public transport of policies governing the environment in the widest sense need to be understood. Policies can enhance the role and functioning of public transport and can work against it. Not all policies are necessarily in the control of the urban public transport planner.

Veeneman (2002) identified some broad links be-

Tasks and functions of a passenger transport authority

	Task	Functions
Organisational	Ensure that it has the structural, personnel and financial capabilities to carry out the assigned tasks, and does so within prevailing laws and accounting principles.	Administration, reporting, capability, legal
Financial	Secure, allocate and disburse the finances required for all authorised activities.	Budgeting, sourcing/securing finance, allocation of funds, disbursement, capital expenditure
Policy	Develop, adapt and articulate transport policy, including in relation to land use and other urban policy.	Transportation policy, urban public transport policy, coverage / service parameters, quality parameters.
Regulatory	Establish and manage the processes for regulating the supply of passenger transport.	Develop regulations, assess applications, issue licences, control licensed operations, control unlicensed operations, manage licences.
Planning	Develop the accessibility requirements for the area of coverage, and determine the implication of these in terms of a passenger transport network: routes, detailed timetables and/or service parameters for all modes covered by the entity.	Information gathering, quantifying accessibility needs, high-level network design, detailed network design, forecasting, integration.
Fares	Establish the framework for the fare system and tariffing levels for the public transport offer.	Set or regulate tariff levels, determine fare structure, integration and fare products, and establish systems for ticketing, sales and distribution, revenue collection, clearing and revenue protection.
Procurement	Develop and manage procedures to procure the planned or alternative transport services in accordance with pre-determined objectives.	Develop procurement strategy, develop procurement procedures, prepare tender documentation, administer tender process, negotiate tendered contracts, negotiate non-tendered contracts, manage contracts and re-bid process.
Intervention	Plan and implement intervention measures to align the transport service with organisational objectives.	Stimulate competition, determine appropriate barriers to entry, adapt contracted services, monitor and correct the services, plan and carry out investments in infrastructure and deal with emergency issues.
Promotional	Promote the public transport modes in political, image, operational and informational terms.	Provide traveller information, customer-facing services and travel demand management, specific marketing and general market positioning.
Political	Establish and manage interfaces and discussions with societal stakeholders and government decision makers..	Political lobbying and the development of relations with customers, local communities, businesses and non-governmental organisations.

Source: Finn and Nelson (2003)

tween policies and their effect on public transport. In particular the following policies will interact and be enhanced by consideration within a public transport policy framework:

- ▶ Social Policy
- ▶ Urban Planning
- ▶ Environmental Policy
- ▶ Economic development
- ▶ Traffic Safety

Close co-operation between transport and land-use authorities is also important. Van der Maas (1998) identifies supportive land-use policies as a vital component of transport policy implementation. This is shown, for example, by the different experiences in Helsinki and Bratislava by the TRANSECON project. In the former, much of the metro project passed through land owned by the local authority, which could then promote public transport friendly land uses without the need for partnership with the private sector. This was also true before 1990 in Bratislava where development could be focussed on project corridors. However, the prevailing paradigm favoured single land-use, which resulted in unnecessary and inefficient trip making.

Other examples with strong local and regional government structures, such as Stuttgart, Vienna, Lyon and Zürich, were only partially successful in encouraging land-use beneficial to the transport projects, as they required good collaboration with private interests.

In Bratislava urban renewal and re-conversion of old industrial zones is occurring along the corridor of the tramway extension. The transport company is participating in the preparation of a new shopping and business zone. In the corridor of the bus extension there is urban renewal on a somewhat smaller scale.

Land-use planning in France was, in the period of the so-called Plans d'Occupation des Sols, orientated towards the definition of the main axes and the reservation of land and alignments for infrastructure. This was the case for the new metro line in Lyon. With the Transport Plan of 1995, however, a reference document allowed for higher levels of

land-use all along the main transport lines to provide a good level of usage and attractiveness of urban transport. Yet a majority of Lyon respondents who were consulted think that car use is more important for land-use and structural modifications in a region. In the case of the metro line D, the extension to the western district of Vaise, associated with a new part of the ring road, was linked with a deliberate action by the public transport operator, the local authority and some private investors to breathe new life into the old industrial districts, in terms of residential, office and high value-added business developments.

The best outcomes occur when there are supportive land-use and traffic restraint policies, as opposed to a lack of land use policies that discourage the use public transport, such as zoning that specifies only one land use.

Best practice occurs when there are open planning policies that involve actors at all levels, from local people to national government. To maximise the economic potential of transport activities, close co-operation needs to be encouraged between transport authorities on the one hand and land-use authorities, developers and private businesses and investors on the other. Private businesses may require positive incentives to locate near public transport rather than a cost burden for not doing so.

Regional body important for integration

A well argued solution for public transport organisation is the establishment of a single organisational entity with responsibility for all public transport within the urban region (city and hinterland). Ideally, this regional body should not only ensure institutional co-ordination between different levels of public transport, but also with other agencies concerned with traffic (e.g. parking and pedestrians) and urban planning more generally (e.g. traffic calming). Experience from the numerous public transport regions in Germany show that many different organisational set-ups can be chosen within a given national legal framework. However, whatever the organisation is called, the success for public transport depends on the functions carried out by this body.

The empirical evidence suggests that the best outcomes have occurred in cities within a regional body structure, but there are also regions with a regional structure which for some other reason have not achieved good practice outcomes. This suggests that whilst a single regional entity may help, it is not necessarily the solution by itself.

Most European countries have a tier of government between national and local which is regionally based. Exceptions are the UK and Finland, where there are typically two tiers of government (national and local) and countries such as Belgium, Italy and France, where there are four.

In the typical case, the regional transport bodies have control of public transport and have been specifically set up for this purpose. In some cases they also have responsibility for other functions at the regional level. In Copenhagen and Helsinki the regional body has some influence over road planning, and in Belgium the regional government has responsibility for public transport and regional roads.

Regional bodies are usually associated with giving direction in transport matters. For successful public transport however, they also:

- ▶ Facilitate cross-border integration of services, and
- ▶ Make the provision of integrated ticketing schemes a reality.

These two characteristics appear to be driving increased public transport ridership, leading to the exploitation of potential economies of scale and consequential lower subsidy requirements. However, whilst a regional body is not required to provide these attributes, the empirical evidence is such that these two crucial elements of successful delivery of transport policy do not occur without the existence of a regional body.

Better practice would appear to need a regional body, although this does not guarantee success in terms of key public transport planning attributes. In the UK, whilst the Passenger Transport Authorities (established under the Transport Act, 1968) do have region-wide responsibilities, the process of deregulation removed the power to provide integrated services. Their responsibility is to provide essential services

not provided by the market. Even where region-wide tickets exist, they are expensive because they need to reflect commercial rather than subsidised fares.

Less good practice occurs when there are conflicts between the different tiers of government, particularly when there are conflicts of policy between different local interests or between local interests and the regional body. In addition, fragmentation of decision making, such as occurs in Dublin, can act as a barrier to successful implementation of policy.

Less good practice also occurs where there is a lack of integration between bodies responsible for transport within and between tiers of government. For example, in the UK there is a badly defined relationship between the current (although soon to be wound up) Strategic Rail Authority (which has responsibility for the overall strategic direction of the UK rail network and whose remit includes the letting and managing of passenger franchises), the Greater London Authority (which has responsibility for strategic transport planning) and Transport for London (whose responsibility is to put the strategy determined by the GLA into practice).

Less good practice occurs where there are too many bodies responsible for the delivery of transport policy. In Lisbon, there are more than six different public bodies responsible for delivery of public transport, with no co-ordinating regional body.

In the Oslo region the responsibilities for public transport operations are divided between two counties and the state that is responsible for all railway services, even local trains. In addition, public transport infrastructure is catered for by several central government agencies, the counties and more than twenty local authorities which also have a monopoly on land-use planning. (Nielsen and Ringquist 2004).

Better practice occurs when there is an open planning process involving all levels of government which positively interact with local interest and pressure groups. In many cases an open planning process can be used as a way of overcoming the difficulties caused by the division of responsibilities between the different tiers of government.

Better practice occurs where the regional body

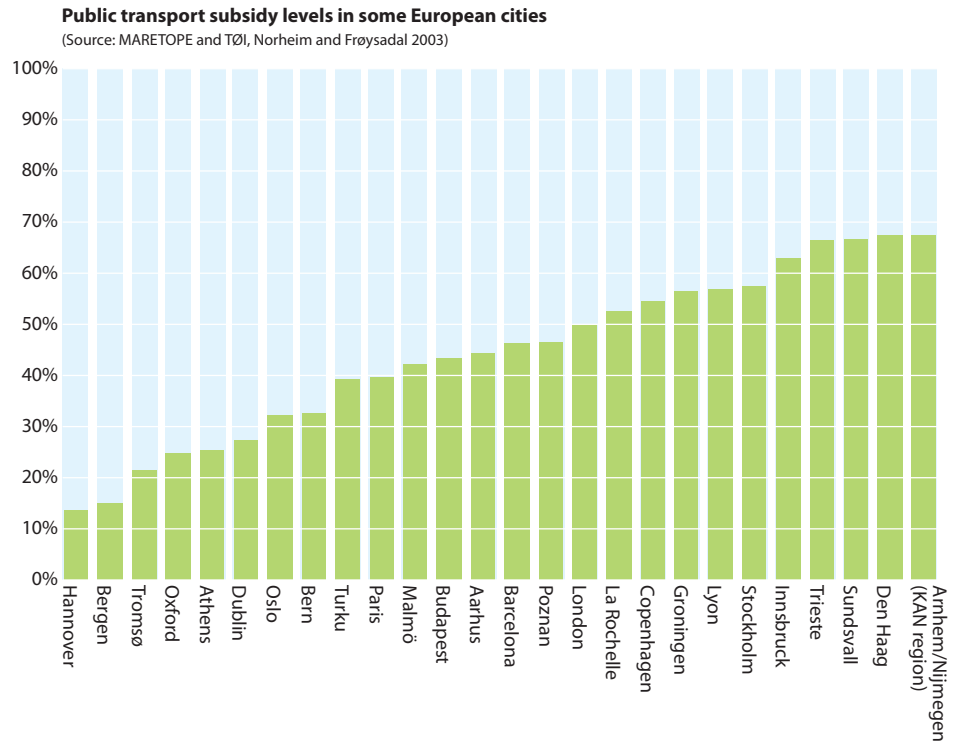

Financial comparisons between some European cities

	Population (1000)	Subsidy per head of population (£)	Public Transport Investment per head of population (£)	Single Fare (£)
Madrid	5600	53.57	5.36	0.65
Barcelona	4228	16.56	0.59	0.65
Copenhagen	1800	111.11	4.58	1.00
Helsinki	1200	70.83	40.00	1.50
Stockholm	1500	141.33	100.00	1.20
London	7000	28.57	42.86	2.00
Munich	2500	72.00	200.00	1.20
Zurich	1200	125.00	16.67	1.50
Edinburgh/Lothians	700	58.57	21.42	1.30

Source: Adapted from Colin Buchanan and Partners (2003)

The parameters of competitive tendering

- ▶ The basic network structure
- ▶ Detailed route design
- ▶ Detailed timetable design
- ▶ Fare structure and ticket types
- ▶ Price levels for basic fares and for specific fare products
- ▶ Vehicle types and capacity
- ▶ Vehicle characteristics (emissions, safety, accessibility)
- ▶ Operational characteristics
- ▶ Service quality
- ▶ Degree of integration
- ▶ Customer support services (ticketing, information)
- ▶ Freedom for innovation or adaptation by the operator
- ▶ Inclusion of societal or other goals

Source: Finn and Nelson (2003)

effectively integrates and markets public transport services (operations and infrastructure) and provides an integrated ticket and fares policy. The provision of an integrated passenger information service is another essential element of good practice.

The regional body should also consider the infrastructure requirements together with service planning. For example, there is little point in developing accessible vehicles if stops are not similarly accessible.

Better practice occurs when there is a clear organisational structure that identifies the roles of each body and provides mechanisms to prevent barriers to co-operative working. It is important that a regional authority exists with sufficient financial

and executive powers to implement infrastructure projects of regional benefit. This should ideally cover all centres of population which might usefully be served by the transport activities. The importance of this body is to provide an integrated service, ticketing and fares system which functions across local boundaries.

The market environment and its consequential characteristics demand that the transport planner clearly understands its role. By defining the functions of a passenger transport authority in generic terms, the full set of potential actions can be identified.

Propensity to fund public transport expenditure

The funding of public transport falls into two categories: capital funding and revenue funding. In the main, funding comes from a mixture of central and local government, with major infrastructure being funded by central government through loans or direct grants and smaller infrastructure projects being funded by local taxation and revenue support for public transport from local and sometimes national taxation.

Some regional authorities, such as Stockholm, have the ability to levy local taxes. While this is not the norm, other regional authorities can raise money for specific projects using the taxation policies of their constituent local authorities when this has been agreed to.

Innovative approaches to funding can be made. For example, learning from industry, the leasing of capital items such as buses, metro rolling stock, LRT and suburban rail can transfer these from a capital to a revenue item.

Revenue raised by the use of specific taxes for the funding of public transport (hypothecated taxes) is rare but extensively used by a few cities. In French cities a payroll tax ("versement transport") is used to predominantly fund the revenue support for bus and metro. In Germany an important source of public transport funding is the national fuel tax earmarked for public transport infrastructure (earlier also for rolling stock), catering for some 70–85 (earlier)

percent of the approved project costs in German cities. In general, regional transport bodies are reliant on their local authorities or central government for funding as they have no individual revenue raising capabilities.

Within Europe, London and the biggest Norwegian cities have local taxation, national funding (in terms of block or project grants) and road user charging as potential or actual sources of funding. There is little evidence of public-private partnership in the funding.

Funding levels vary enormously between different cities. Lack of funding for revenue support appears to affect the take up of public transport by travellers whilst lack of capital funding can retard (or in the worst case, prevent) the achievement of transport policy objectives.

There are very large differences in subsidy levels between European countries. UK (outside London), the only truly deregulated country, has a low level of subsidy. The partly regulated countries that have introduced tendering, like the Nordic countries, have subsidies in the middle range. Regulated countries have high levels of subsidies (Carlquist and Johansen 1999; based on ISOTOPE 1998 and Norheim and Carlquist 1999).

But even within countries there are big differences in the level of subsidy in different regions and cities as shown by the MARETOPE project and Norwegian studies (Norheim and Frøysadal 2003). This reflects differences in political priorities and financial abilities of the authorities responsible for subsidies and public transport policy. The subsidy levels also reflect different geographical conditions and hence the perceived need for public transport, as well as varying opinions of the effectiveness of a low fare policy for the achievement of public transport objectives.

Clearly linked to the issues of the existence of regional bodies and funding is the importance of integrated fares. In all cities where there is an increase in public transport ridership and/or an absolute decrease in private car travel, there is an integrated ticket system. This is also substantiated by other

The unique system of public transport funding in France

The funding of public transport explains much of the development of rail-based public transport in French cities.

By legal regulation from 1982 local authorities may impose a special payroll tax on businesses and public bodies with more than 9 employed persons in urban areas. The revenue may be used for public transport infrastructure and operations, pedestrian and bicycle facilities and for environmental upgrading of streets and public places in the cities. The maximum level of this taxation is 0.55 percent of the wages in cities with a smaller population than 100,000 and 1.0 percent for larger cities. In order to stimulate the development of public transport based on rail, cities that choose to have rail systems are allowed to charge up to 1.8 percent of the wages.

The philosophy is that businesses and other organisations located in the cities benefit from improved transport and urban environment, and therefore should help to finance the necessary public measures. The beneficial effects of rail systems are perceived to be greater (as indicated by their effect on land and property prices), and this justifies the higher rate for this purpose.

The funding of urban public transport in France looked like this (both investments and operational costs) in 2000:

- ▶ The transport tax: 41 percent
- ▶ Local government support: 17 percent
- ▶ Central government support: 7 percent (taken away from 2005)
- ▶ Loans and other resources: 17 percent
- ▶ Income from the fares: 18 percent.

Source: Aas 2005, based on information from the French Directorate for Land Transport.

studies (Fairhurst and Edwards 1996). These two issues are linked because there needs to be a body 'above' the local level that is able to look at cross local area border issues.

Better practice in achieving modal shift from car to public transport in cities like Stockholm, Munich and Zürich (Buchanan and Partners 2003) seem to come from spending significantly more on subsidy per head of population and from having lower fares. However, these success factors are also linked to the implementation of land-use and parking constraint policies. For instance, Adelaide has higher subsidies than any of these (at least as a % of operating revenue), yet still has very low public transport use.

Trends towards off the road competition

"Off-the-road" competition is arguably the strongest emerging trend, and the one with the greatest complexity from the perspective of the authorities, of organisational frameworks, and of the legal/regulatory frameworks.

This requires the authority to take the lead in specifying the service attributes (although this can be at the strategic level, leaving the detail to the operator), establishing and implementing a mechanism for inviting potential operators and selecting among them, establishing and controlling the basis on which the services are provided, and intervening over time as required.

Competitive tendering encompasses a broad cluster of mechanisms used to obtain services through the open market, while maintaining a desired level of control over key attributes of the service. In the specific case of the bus market, it allows the transport authority to use the market mechanisms to choose among potential operators across a range of factors including price, quality, quantity, degree of innovation and capability of the operator. Hence, competitive tendering can range from procuring a single operator to design and operate the services for the entire area through to all attributes being specified in detail (effectively sub-contracting production tasks). This variety of contracting possibilities applies so far only to buses. The range very

much reflects the objectives of the authorities, and the culture in the host environment. There are no instances of partial rail-based tendering.

Jansson (2002) examines the effects of competitive tendering in terms of cost reductions, ownership of assets and vehicles, specifications of quality, principles for tendering and contracts. Tendering of public transport services has, in all reported cases, been associated with a reduction in the subsidy required for the provision of an equivalent service. Overall cost reductions have been identified ranging from 40–60% in San Diego and Los Angeles and 45% in Gothenburg. These cost reductions come from reductions in the wage rate to drivers, reductions in administration, reduced workshop staff and more intensive use of the workforce (Jansson 1996).

A wide variety of instruments are available to select the preferred operator. As authorities are increasingly required to have transparency in the allocation of both operating rights and public finances, an increasing number of cities are using some form of open competitive process with clear requirements and evaluation procedures. This can be broadly classed as competitive tendering.

In a competitive tendering regime, the authority will determine the degree of control it wishes to exercise. This can include some or all of the attributes identified by Finn and Nelson (2002). Thus, competitive tendering is a broad cluster of mechanisms used to obtain services through the open market, while maintaining a desired level of control over key attributes of the service. In the specific case of the bus market, it allows the transport authority to use the market mechanisms to choose among potential operators across a range of factors. Competitive tendering has been shown to be a steep learning curve for some operators and tendering authorities with major changes in costs occurring between successive rounds (Jansson 1996).

Obviously, the more attributes specified by the authority, the less freedom remains for the operator, and this influences the nature of the bidding process and the allocation of risk. It also requires an increasing level of input and expertise on the part of the

tendering authority, although some of this can be bought in through consultant firms or secondments.

There are also issues of infrastructure ownership, particularly in the development of public/private partnerships. Evidence suggests that the greatest efficiency is afforded if vehicles are wholly owned by the operators (whether leased or directly owned) whilst the evidence relating to other infrastructure such as depots, is more mixed.

Gross Cost or Net Price contracts?

Alongside the specific elements of the tender discussed above, there are a number of practical issues that are important in the context of tendering. How is the subsidy paid, how are the routes packaged for the authority to tender and how long is the tender period? In this context, there are two main variations of tendering: contracts can be let on a Gross Cost or Net Price basis.

In a Gross Cost tender, all the fare box revenue is kept by the tendering authority. In a Net Price tender, all the fare box revenue is kept by the operator. Gross Cost tenders are therefore always higher than Net Price tenders, but the actual subsidy paid to the operator can actually be less in Gross Cost tender than the Net Price tender if the service is successful in terms of fare box income. From the tendering authority's point of view, a Gross Cost tender has a number of advantages for services that are thought to have a latent demand which with appropriate servicing, could produce a healthy level of fare box income, which in turn means less subsidy. Against this, a Gross Cost contract leaves little incentive for the operator to develop the service.

With a Net Price tender, the operator receives a static subsidy payment and even if the service is very successful in terms of fare box revenue the operator receives the same subsidy payment and therefore all the benefit is enjoyed by the operator and not the tendering authority. Against this, the operator has a higher incentive to develop the service as they receive the benefits from any higher patronage.

Incentive schemes

Innovative payment methods for supported services in Norway (Carlquist 2001) introduced in 2000, have linked payments to the bus operator through an incentive scheme that pays for results (i.e. increased patronage) rather than shares the costs of provision.

A similar scheme has been introduced in New Zealand (Wallis and Gale 2001) where funding has been based on a kick-start funding and a patronage incentive. Economics based research in Australia (Henscher and Stanley 2002) has argued that, as a model of supporting local passenger services, this is superior to the process of competitive tendering.

However, tendered gross contracts for bus services in Oslo include both specific incentives and penalties (Aas 2004). A basic service level is defined in the contract, and the total contract sum may be increased or reduced by up to 3 percent per year depending on the actual quality delivered by each bus operator. The fulfilment of the specified service requirements is monitored by a mix of passenger interviews and the authority's inspectorate reports, based on some 1000 inspections per month.

Multi-modal integration – a key to good network planning

Institutional practices are also important for the co-ordination between different modes of public transport. There is a wide experience of co-ordination between tram/light rail and bus systems for a mixture of ownership and control regimes. Ensuring co-ordination in the urban public transport system as a whole is the key to good network planning. This is informed by an understanding of the institutional contexts, the lessons from big institutional reforms, a minimisation of the institutional barriers and good use of the incentives that can be employed by government.

Better practice occurs when there is co-operation between all transport providers, whether under public or private ownership. To this end, it is helpful that authorities are not seen as giving preferential treatment to one or the other. National anti-monopolistic legislation may need to recognise the particular advantages of public transport integration.

Quality contracts for bus and light rail operations in Oslo

	OS-bus	N-bus	S-bus	OS-tram	OS-metro	All
Percent of passengers that are satisfied with their trip						
General satisfaction	88	86	82	87	82	85
Punctuality	84	82	82	78	81	82
The driver's style of driving	81	74	71	85	–	80
In-vehicle cleaning	67	73	70	64	45	59
Percent of inspections where contract requirements were fulfilled						
Punctuality (delay under 4 minutes)	86	82	74	73	88	84
Style of driving	84	74	70	87	–	80
Announcement of stops	66	32	34	89	79	68

Quality monitoring is carried out through regular market surveys among the passengers, and through surveys made by quality inspectors. Five operators of bus, tram and metro in different parts of Oslo have their quality results openly published, and the results affect directly the monthly payment for the services provided in the Oslo city bus network. The monitoring is also directly reported to the operators' personnel, so that a quality culture is encouraged in the entire organisation and all operators.

The table gives an example of some of the results of the different operators in the period May–September 2004. The results indicate areas in need for improvement by the different operators.

According to the contracts for the bus tenders, the operators must pay a fine for each case the inspectors register as being below the specified service level.

5000 NOK (in 2004 some 610 Euros for each case) must be deducted from the monthly invoice for:

- ▶ Leaving a bus stop ahead of schedule
- ▶ Missing or incorrect ticketing
- ▶ Use of wrong type of bus (or bus colour)
- ▶ Exhaust particle cleaner not working

3000 NOK (some 360 Euros) must be deducted for:

- ▶ More than 2 minutes late departure from a bus stop
- ▶ Missing or incorrect destination and route information on the bus
- ▶ Defective or partly defective stop signal
- ▶ Bad cleaning and maintenance

1000 NOK (some 120 Euros) must be deducted for:

- ▶ Missing announcement of next stop
- ▶ Missing timetable leaflets and folders about fares and customer service quality guarantee
- ▶ Prescribed uniform of driver not used

Source: Aas 2004, based on information from Oslo Public Transport Ltd

Route or network tenders?

In the UK, deregulation of buses was accompanied with provision for the competitive tendering of 'socially desirable' routes awarded by means of a competitive tender. In the UK context, competitive tendering in London was unique in that it more closely matched the franchise approach with area networks being put out to tender. This is in contrast to the rest of the UK where competitive tendering is on a route by route basis (with the potential for grouping routes in bids).

The flexibility offered by the network approach means that planners are able to restructure services more effectively than on a route by route basis in particular to introduce a mix of bus sizes in the operator's fleet.

It is nevertheless important to remember that there are learning costs when moving from one regulatory regime to another when particular operators benefit from having superior information. This means that deregulation or other structural changes could be associated with short term instability until such time as the information gathering and strategic behaviour of other operators catches up to restore an equilibrium in the market (Henscher and Beesley 1989).

In the UK, the Transport Act 2000 has taken this one step further with the potential for Quality Bus Partnerships, where minimum quality standards are identified in return for additional infrastructure benefits for buses. For example, the local authority could implement further bus lanes or bus priority at traffic signals or real-time passenger information at bus stops and allow any operator meeting specified quality standards in, for example, type and age of bus to use them. This contrasts with the new Quality Contracts in the UK (also made permissible under the Transport Act 2000) where specific standards are agreed with an operator for a particular route and the contract grants that operator a monopoly over that route. In both cases, however, there is likely to be a concentration on key corridors at the expense of area-wide coverage of services.

Within Europe more generally, with the preponderance of regional bodies that plan transport networks, tendering is associated with the letting of contracts on an area or franchise basis. This has the benefit of giving transport planners the responsibility for the design of the network (including timetable and fares) but securing the operation at lowest cost.

Finn and Nelson (2002) note that network planning is about more than just the lines and timetables. It determines the resources used by the services, and hence the cost. It also determines the quality of service offered to the potential users, and hence the potential revenue base. As network redesign often happens prior to tendering out, there are substantial risks that need to be fairly allocated. However, it is not easy to allocate the risks in such a way that the operator is given the freedom or incentive to develop the network and its services. A solution might be to offer contracts whereby an incentive is given for network development.

In South Africa and in the demonstration of competitive tendering in the Netherlands, external consultants were used to plan the network and the operators bid for these revised services. It is not yet clear whether the demand, revenue and cost forecasts are robust, and hence whether either the bidder or the authority has accepted a risk which they have not adequately priced.

There needs to be clear mechanisms to adapt the services either in the early phases or over the contract life. In Adelaide, the responsibility for the network planning has largely been transferred to the operator, and it is a requirement that they regularly review the network. This places a substantial skill need on the operator, but also requires a good working relationship with the authority and both the mechanisms and the willingness to allow operator proposals to be implemented.

The length of the contract will be a trade-off between having as short a cycle of re-tendering as possible (to ensure the keenest prices) consistent with allowing operators to have a sensible investment policy. In turn, a 'sensible' investment policy

will depend on the mode and the length of life of the asset.

Better practice comes from area or franchising routes if the network is properly planned for this. When a new network structure is planned, a fair allocation of the risks must be made between the operator and the tendering authority.

In this regard, the best outcomes result from a realistic assessment of whether a route is likely to have a latent demand and thus whether the operator or the tendering authority should take the risk. In this context, tendering should seek tenders in both formats for full information.

It needs to be recognised that structural change can give rise to information asymmetries which in turn can give rise to instability. Major changes in networks and/or regulatory frameworks should therefore be associated with shorter contract durations.

Different modes have different economic lives and so the length of contract should be related to a period that allows operators to make sensible investment decisions.

Regulation and co-ordination still good practice

National authorities can be significant players in local transport projects through the legislative environment they create.

This is a notable influence in the UK, where privatisation of the bus industry and pro-competition laws make integration of urban transport services difficult. Such legislation may also restrict the fares that a subsidised operator can charge. Tyne and Wear retains some benefits of its formerly highly integrated system despite deregulation (although in effect the Metro now operates as a free-standing railway), but the newer Manchester LRT system has not yet been able to achieve facilities such as through ticketing between bus and LRT services other than for single combined mode journeys.

Close co-operation between local and regional levels of government and the formation of a regional transport authority or association are important conditions for providing a product that satisfies the



BETTER PRACTICE

Better practice emerges from regulation which allows co-ordination, while less good practice appears to be associated with full deregulation.

public transport needs of inhabitants as well as economic interests. Under such an umbrella competition among transport operators can more easily be successfully initiated.

The Stuttgart and Zürich cases demonstrate this. In the latter case and in Madrid, costs are shared between these two levels. In Valencia, an initial lack of co-ordination between the local and regional authorities gave the Metro project a less favourable operating environment, as the local government failed to integrate other public transport services and promoted car-friendly policies in the central area. However, a new regional investment authority has since improved the co-ordination, in this case to fulfil objectives of urban regeneration.

No literature which has been concerned with identifying good practice in any area of transport policy has selected a city in which road-based urban public transport is deregulated: a public body of some kind is in control of fare levels and service specifications.

“Soft” public transport measures

So-called “soft” public transport measures have been increasingly recognised as an essential aspect of the public transport planning process. “Soft” public transport measures complement the “hard” (more engineering-based) measures such as the provision of actual public transport infrastructure (e.g. a bus lanes, LRT tracks or public transport interchange) as well as rolling stock. A wide variety of measures are recognised including:

- ▶ Integrated tariff schemes
- ▶ Marketing
- ▶ Branding (e.g. of specific routes)
- ▶ Passenger information (including timetables), and
- ▶ Public transport awareness raising campaigns.

The concept of “seamless travel”, which has been prominent in policy statements of national governments (e.g. the UK government’s Ten Year Plan 2000) relies heavily on the widespread deployment of appropriate “soft measures”. The “penalty of transfer” – a major impediment to public transport use – can be eased by provision of passenger integrated ticketing, customised information, user-friendly waiting environments etc.

The provision of high quality, accurate and reliable information is a typical example of a “soft” public transport measure whose impact has been documented widely (see for example IHT 1995). Passenger information may be provided in dynamic (i.e. real-time) or static forms, depending on the requirements of the traveller and the availability of supporting technologies. Mulley and Nelson (2000) have highlighted the potential of transport telematics to support the information requirements of travellers.

“Soft” measures can play an essential role in the delivery of high quality public transport systems. The disintegration of the integrated public transport system of Tyne and Wear as a consequence of deregulation and privatisation of bus services following the Transport Act (1985) generated a clear (and urgent) need for comprehensive area-wide passenger information but created an operating environment in which it was very difficult for operators to engage in the necessary co-operation.



BETTER PRACTICE

Better practice occurs when “soft” measures are considered from the outset of the public transport planning process rather than an addition after service implementation.

2.4 Gaining support for public transport development

In democracies the development of high quality public transport is only possible with strong political support. Managers and politicians responsible for public transport must demonstrate the ability to achieve good results, and create alliances by exploiting the positive external effects from high quality public transport solutions.

Deserve trust and show confidence

The basic condition for gaining support for public transport development is to deliver results that satisfy the expectations of the customers, the voters and the politicians. But developments must be realistic and recognise that there are some developments that are not possible in the short-term because the boundaries are fixed by existing legislation or organisational structures, while other, more long-term measures might need a change in attitude, for example, by increasing public participation or a change in the legislative framework.

Those responsible for public transport must first do their “homework”. In particular, the service must function in accordance with the timetables announced, the system must be felt to be reliable and safe, and the state of maintenance and general appearance must be of a reasonably high quality to satisfy the general expectations of the citizens. Good management control over the economics of the system and absence of strong industrial conflicts are also basic requirements.

Understand the role of local politics

Many public transport projects are born out of political initiatives. Colin Buchanan and Partners (2003) note that political consensus is an important component in many of the cases they considered.

Some analyses, such as in the two TRANSECON UK case studies (Tyne and Wear and Manchester), have suggested that bus-based solutions may be more cost effective than metro or light rail, but the latter type of system is often preferred by politicians as a matter of civic pride or image. The emergence of a new generation of guided buses (e.g. in Leeds and Bradford in the UK) has, however, helped to inject a light rail type image into bus services.

In some of the TRANSECON case studies, there was a significant interplay between political parties in public transport decision making. Generally, parties on the left have supported public transport investment, but in Helsinki, Tyne and Wear and Zürich, they were opposed in some measure by right or centre right parties who preferred better road infrastructure. This did not prevent collaboration in Zürich, although the right wing canton government rejected some complementary measures restrictive to car traffic outside the urban area. In Helsinki and Tyne and Wear the political competition was greater, and a certain amount of political intrigue was said to have surrounded the local administrations that implemented the LRT/metro projects. In Stuttgart and Valencia on the other hand, consensus between main political parties was helpful to project approval.

In France many of the tram projects, for instance in Grenoble, Strasbourg and Montpellier, have played a significant role in local politics and election victories of strong mayors. This is connected to the fact that the city mayors have very strong powers, both financially and political in the French political system.

The importance of trade union support has been stressed in certain cases. In Tyne and Wear the unions were key actors in the planning and approval stages of the Metro, although that has much to do with the political climate of the 1970s. The Metro was a product of the creation of the then Tyne and

Wear County Council in 1974, over which rail unions used their influence to push for a rail-based public transport system, to heavy rail standards. However a subsequent dispute with the authorities over working conditions set the tone for much of the industrial relations difficulties which were to follow. On the other hand, the bus workers union was worried about possible redundancies in the bus industry. Additionally the bus industry felt that the amount of local funding the Metro attracted was disproportionate in comparison with the bus. Nowadays however the unions are more likely to be in dispute with the Metro over the financing of its operational deficit, which they say requires a “massive injection of public money”.

Restriction of car traffic can be one of the main reasons for political opposition to some projects. Zürich and Manchester found this to be one of the few contentious issues, whilst the Delft cycle project learned from a previous experience in The Netherlands that motorists needed to be reassured that their road space would be maintained.

Local democracy has been shown to be in some cases significant. In Tyne and Wear, public transport policies, including the Metro, were a major issue in electing the first council of the newly-established metropolitan county in 1974. In Zürich, the project was put to popular vote, which significantly proved the citizens’ preference for public transport over better road infrastructure. Additionally Zürich voters have had an important influence on the type of project implemented, having twice turned down underground solutions for public transport. Instead they preferred an S-Bahn system on the regional level and for clear tramway and bus priority on the urban road system.

Better practice occurs where there is political consensus and a long-term commitment to particular transport policies.

Co-operate with local stakeholders

In the early days of public transport systems, land use exploitation and land development was an integrated activity that attracted many public transport companies. New transport connections by rail or bus created accessibility to undeveloped land and the profits from increasing market prices for urban land could in many cases provide funds for the building of the new transport infrastructure.

After the motor car became the dominant means of transport and as cities have stopped rapidly expanding into the surrounding countryside, opportunities are far less common. Generally, there are few examples reported of private sector co-operation in public transport project planning and implementation, apart from in the financing and construction aspects.

Of the TRANSECON case studies only Manchester and Zürich give examples of private businesses supporting project approval. Vienna had the co-operation of local retailers in some detailed aspects of project design. In Helsinki, local traders partially funded a new station, although this was not a success due to an economic downturn. A property developer in Tyne and Wear is planning to do likewise, but this has not yet been implemented.

The TRANSECON case studies provide only one example of transport authorities working closely with private investors to maximise development potential of a project area. In Brussels, one land-use planner went so far as to state that “the public transit operator is not supposed to be involved in real estate operations”. The exception mentioned is Lyon, where the public transport operator co-operated with investors and the local authority to develop the former industrial area of Vaise as discussed below. In general this function is left to the real estate market.

However there are a few examples where either the transport operator or local government have taken the initiative with private real estate investors for site development. More often one finds efforts for co-operation between transport and land-use planning within public administrations. Such interaction can lead to a controlled increase of density, more

efficient urban regeneration processes, a counterbalance to urban sprawl and thus a better outlook for the public transport market. This means that synergistic effects can be promoted in an appropriate way.

In Bratislava (pre-1990) and in Helsinki, the local authorities themselves had responsibility for areas adjoining the LRT/metro project and could develop them. This echoes the situation in Hong Kong and Singapore where, according to Fouracre, Allport and Thomson (1990), land-use authorities were able to develop areas around metro lines to maximise patronage and justify the transport infrastructure. Although private developers are now becoming important in Bratislava, the state-centred thinking is slow to change and there is much administrative inertia inhibiting their efforts.

In the other cities, it was generally left to the private sector to develop different areas according to their own perceptions of accessibility. Vienna and Valencia are examples where development, particularly of housing, has been influenced by the projects studied. However, in Zürich and Tyne and Wear, it was stated that many developers preferred other areas with good road access. On a more positive note, Zürich has seen an interesting experiment in collaborating with local investors and businesses to encourage development around certain S-Bahn stations, providing useful services and restricting car parking.

Van der Maas (1998) reports that implementing public transport improvements as part of wider economic regeneration policies can pay dividends.

In the city of Oslo, the building of the new ring metro line has been possible due to close cooperation between the city of Oslo and the developers of Nydalen former industrial area, which is to be served by the new line.

Better practice occurs when public transport improvements are implemented as part of wider economic regeneration policies, or to open up new areas for development.

Create alliances with local interest groups

Many of the TRANSECON projects studied were fortunate in that they could be implemented without significant opposition from interest groups. Generally, projects were perceived as being beneficial, or at least non-harmful, to most sectors. In Valencia, Manchester, Stuttgart and Tyne and Wear, this was helped by the fact that existing railway lines were converted, minimising disruption of new construction. In Vienna and Athens, the high proportion of underground construction minimised externalities. Local opposition was limited since fewer people were directly affected by the building projects. In Vienna little participation was seen as necessary at first, although it is now standard procedure.

The example of the Delft bicycle network policy particularly brings forward insights. The project was largely adapted to a very specific local context, and its development was characterised by sensitivity to local interest and clever avoidance of confrontation. Consultation exercises with local people and interest groups about local transport problems were taken into account in the project design, which was an important factor in the positive public attitude and the subsequent success of the cycle network. In Valencia, the authorities claimed a high level of consultation in the project planning stage, although this was not always perceived by residents.

As far as participation in the operation phase is concerned, few examples have been identified. In Tyne and Wear, a cycling pressure group has had limited success in getting the Metro to improve its cycle facilities, and some environmental improvements requested by local residents have also been carried out by the Metro.

Better practice comes from involving wide participation at all stages of development, from a project's conception to its operation phase.



3 Network structure design

3.1 Combining structural stability with market adaptability _81

- A stable structure that can influence urban development _81
- Stability requires robustness _81
- Adaptability through demand-sensitive frequencies _82
- Supplementary services for access and small market segments _82
- A network structure open for future developments _83

3.2 Exploiting the network effect _84

- The importance of high frequency _84
- Understanding the network effect _84
- Challenging low demand situations and infrastructure restrictions _89
- Some lessons from Zürich – the benchmark city of public transport _89

3.3 Defining the main elements _94

- Simple lines with stable routes and fixed stopping patterns _94
- Flexibility within classes of frequencies _97
- Try to obtain optimum frequency _97
- High quality transfer points and interchanges _100
- Quality access routes for everyone _101
- The bicycle can increase the catchment area ten times _101
- Access by car _102

3.4 Creating the basis for a simple high frequency network _104

- Concentrate resources – be careful with new lines _104
- Strategies for dealing with peak period capacity demand _104
- Avoiding unnecessary transfers between lines _106
- Public transport is ready-to-use, not tailor-made transport _106
- Many direct lines create a complicated network for users _106
- A complex, multi-line network is difficult to operate _108
- Choosing between direct and feeder lines _111
- Create high quality trunk lines or corridors _115

3.5 Finding strategies for the weaker markets _116

- Common trunk line sections in small cities _116
- Pulse timetables for low frequency services _116
- An integrated approach to small town quality bus systems _117
- Reliable services and interchange design are key elements _118

3.6 Developing an efficient line structure _120

- Find the right length of lines _120
- Pendulum lines are often favourable _120
- Reduce uncoordinated parallel services _121
- Integrate different concessions of operation _122

3.7 Travelling as fast as possible _124

- Define the basic, acceptable walking distance _124
- Consider the effect of stopping intervals on travel speed _124
- Try to improve all factors that determine travel speed _128
- Appropriate interplay between local and regional lines _131
- Route alignment can make the difference between failure and success _133

Designing the public transport network is a complex task. Conflicting objectives and interests must be reconciled. The right balance must be found between the need for flexible adjustment to the changing demands of the transport market, and the need to define a long-lasting network structure for decisions on major infrastructure projects and land use planning. This chapter gives advice on how to develop the network to serve the users and the market in a best possible way, while still taking account of the always restricted amount of resources available for the operation of the public transport system.

3.1 Combining structural stability with market adaptability

The public transport system should be able to adapt dynamically to the changing demands of the citizens and the economic circumstances of public transport operations. At the same time, long-term stability of a high service quality is required for the public transport system to influence urban development and create more sustainable transport patterns. In order to succeed in the market competition with the motorcar, most of the resources of the public transport system must be directed towards the main transport corridors. But such a concentration of resources in an urban region can easily run into conflict with the need to provide a minimum transport service to all citizens irrespective of car availability, physical abilities and area of residence. The following section outlines some basic principles for public transport network planning which can help to balance these conflicting aims and interests.

A stable structure that can influence urban development

To be successful in the long term, the public transport system must form the backbone of urban structure and development and have a stable and high quality service over many years. This stability, more or less guaranteed by the public transport and land use planning authority of the area, is a precondition for influencing urban property development and land use and creating an urban structure that supports public transport as a major mode of transport in the area. Long term stability is necessary for achieving the much demanded high quality and increased market share for public transport in our urban regions.

In order to influence the urban structure and transport demand, the main feature of the public transport system should be to establish a geographical network structure so strong and robust that it can stay more or less unchanged for many years. The long term effects of rail infrastructure and transport systems have been well known for many years. Indeed, much urban development in the first half of the 20th century (and earlier) was

GOOD PRACTICE

Stability

Zürich tramway network:
100 years of 6-minute service headway

GOOD PRACTICE

Stability

A major bus line with a timetable frequency that varies according to time of the day, week and year and over the length of the line, while the main route of the line remains the same

based on the accessibility provided by new railways, tram lines and metro systems. In the early days of buses and motor cars, even bus lines created a similar interactive effect between land use and public transport supply and demand. In today's urban areas, with much stricter competition from the motor car, the strength of the basic public transport structure is more important than ever before.

Stability requires robustness

The request for network stability can only be satisfied if the network is robust enough to incorporate the need for short term adjustments in frequency, capacity, connecting and disconnecting lines and branches. The network should also have the ability to be extended into new areas of urban development without having to redesign large parts of the old structure. Even conversions of transport corridors between bus and rail should ideally be possible without completely altering the network structure of the urban region.

The required robustness is most easily achieved when the public transport system is built up as a simple network of as few, simple and easily defined lines

as possible. The network of only a few lines for each mode of public transport has a number of advantages compared to the much more complex networks that very often characterize our urban regions today, for historical, institutional and other reasons. The robust simplicity will provide a public transport service that is easier to perceive and remember for the users, easier to market, brand and sell, and simpler to plan and operate. All this will support the aim of making public transport more efficient and decisive in the development of new infrastructure, urban development and land use planning.

When the emphasis is on network structure and long term stability, the focus is on the main, “heavy” parts of the public transport system. In order to be of structural importance for urban development, a public transport line must both be stable over time and have a minimum level of service frequency and operation time over the day, week and year. The main line network will cater for a strong majority of public transport users, will normally have the highest use of vehicle capacities, and the highest potential for fares covering the costs of operations. The need for public funding will, however, be influenced by the operating circumstances and the minimum service levels (if any) that the system is required to satisfy.

Adaptability through demand-sensitive frequencies

While offering a stable, geographic structure, the main network must also have sufficient flexibility to adjust the line frequencies and the detailed format of lines to the changing market demand and the economic resources available for the transport operations.

The optimum service levels and frequencies in different parts of the network cannot be decided several years ahead. Through market analyses, transport modelling and operational considerations it will, however, be possible to roughly estimate the frequency levels and capacity requirements detailed enough for long term planning. This is sufficient for making strategic decisions on the overall concept for the network structure.

When making decisions on annual budgets, detailed operational questions, and considering costs and benefits of specific infrastructure projects, more detailed analyses of costs and fare revenues should be made. The detailed optimisation of the public transport supply can only be made during the regular, running of services from day to day and year to year. But it is important that the overall network structure allow for flexibility in the setting of frequencies and service variations over time on particular lines. With a very rigorous concept of standardized service levels, e.g. a 15-minute headway on all parts of the network throughout the working day, an optimum use of resources will be impossible to achieve.

Supplementary services for access and small market segments

Lines that are only serviced a few times per day, and lines that do not follow fixed routes, should not be included in the main line structure planning. This means that areas with little public transport demand should have other transport solutions to give access to the stops, stations and interchanges of the main public transport network. Local access may be provided by various forms of low frequency bus lines, demand-responsive services, service lines, minibuses, taxis, school buses and special transport services for the elderly and disabled.

Obviously, local access will also be provided by walking, cycling and passenger cars.

Even special solutions such as night buses, work buses and other market-adjusted services will supplement the main public transport network. But the idea behind the development of a strong, attractive transport network open to all members of the public and designed for universal accessibility, is to make special, tailor-made solutions less in demand. Some special services may divert resources from the task of creating a good public system. However, special services may also be used to test new markets, thus giving impulses to the further development of the regular public transport network.

 **GOOD PRACTICE**
Rufbus Wunsdorf

In Wunsdorf in the Hannover City region, a flexible, demand responsive service (“Rufbus”) has been in operation for many years as a feeder system to the rail system in a relatively low density suburb. PHOTOS: GUSTAV NIELSEN

A network structure open for future developments

The main network structure should be as open as possible for new developments without having to re-design large parts of the system. Some examples of possible developments that one should try to have in mind when drawing up the main network can be mentioned: Extensions of rail or bus lines outwards from the central urban area to reach existing or new developments with significant transport demand, or for the purpose of connecting to regional main line interchanges. The cutting up of existing, long lines into two or three separate lines may improve punctuality and improve capacity utilisation at the expense of more passengers having to change between lines. The opposite, connecting two lines to one, may often save operational resources while offering more direct travel opportunities. Switching line connections on radial lines through the city centre or other transport hubs may result in more efficient and market-conducive operations. Changes in the locations of stops along specific sections of lines should also be possible without altering the main line structure.

All these examples add flexibility in addition to the opportunities that are incorporated in frequency adjustments on every line in the main network. The rest of this chapter in the guide will show how it might be possible to combine this flexibility with the demand for a strong and stable network structure for the main lines of the public transport system.

3.2 Exploiting the network effect

The aim of HiTrans is to stimulate the creation of public transport systems that can be a real competitor to the motorcar for travel in urban regions. Then two crucial qualities of the system are short waiting times between departures, and an integrated network of services between all areas of significant transport demand. This section explains the network effect and how closely it is connected to the ability to create integrated and high frequency services.

The importance of high frequency

A line in the main public transport network should not only be a line on the map. It must provide a significant travel service. There is a general demand for higher frequencies. This has been revealed through market studies in many places, and is also the conclusion from comparative studies of different cities. However, the level of frequency that is accepted as good enough differs a great deal according to what the public has been used to; for instance between a person living in the central part of a large city versus a suburbanite or inhabitant of a small town. The time of the day, journey purpose and length of the journey also affects the experience of frequency and acceptable waiting time. When the policy objective is to attract people away from the use of cars, a high frequency service level is important.

The relationship between frequency and demand is complicated. Usually the average demand elasticity in relation to service frequency is calculated to be well below +1,0. This means that doubling the frequency might only result in some 20–50 percent increase in the patronage. The average, long term, linear relation between frequency and operational cost means that, from a business point of view, the costs of increased frequencies will in general not be covered by increased traffic income from the fares. The benefits of higher frequencies will be reduced waiting times for the public transport users and the indirect effects of new journeys being made, and of any reduced car use. The benefits that do not result in increased fare income must be paid for through public support.

There is, however, one aspect of frequency and network design that tends to be overlooked or not fully understood: high frequency lines can create a high frequency network, and this is especially important for the public transport system's competitive ability towards the motor car. With adequate service levels on both radial, centre-oriented lines and orbital, suburban lines, the public transport system becomes a more realistic and attractive alternative to the use of cars, or at least to the users of the second or third car in family households.

Understanding the network effect

The importance of the network effect for the planning of public transport networks is so significant that it is necessary to fully understand what this concept implies. A theoretical example illustrates how it is possible to circumvent the problem of diminishing returns in relation to demand when frequencies are increased.

Many studies of urban public transport have found relatively small effects on demand of increased supply through higher frequencies. But the low demand elasticities cited in the literature are usually based on analyses of incremental changes in supply, normally measured in terms of vehicle- or train-kilometres per year in the area under study. The "Squareville" example shows that the growth in demand from increased supply will be much greater if the extra resources are used to create new travel opportunities by making old and new services work together to form a network of lines.

The network effect depends on the assumption that travellers are willing to transfer between lines. In cities and places where both the line network and the transfer points are designed to accommodate this, such changes are being made in large numbers. Unfortunately, much of the research on willingness to transfer is based on hypothetical, stated preferences by users of systems where transfers between lines are unattractive and complicated.

The network effect for the users of public transport

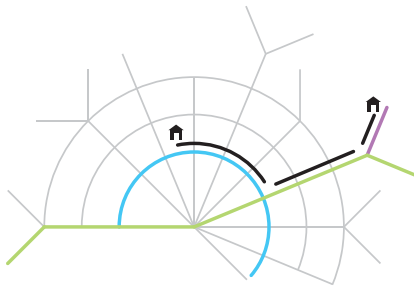

Low frequency network

A collection of lines that function separately if you are willing to plan your journey in detail. The area you can reach by a simple journey is restricted to those places that are within walking distance from the line that passes the place where you are. Change of lines where they cross each other is not very attractive. Waiting times will often be long, and you will need detailed information about more than one line. Transferring is perceived as a large barrier, and these crossing points are seen as being of little value. In reality, it is misleading to call this collection of lines a network.

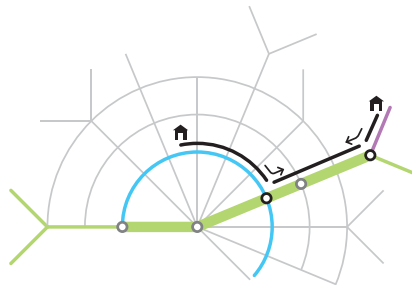

Network with some high frequency lines or sections

The service is good along the lines or sections with high frequency. Transfer is more attractive at places with such a service, but only in one direction, towards the high frequency section. The total number of origin-destination combinations that are given a better service is limited. Even very high frequencies on the best sections will not change this general picture.



High frequency network: Network effect

When all or many of the lines or sections have high frequency, the network effect is created. The network can be used by the public transport passengers in a similar manner to motorists' use of the road network. You may travel everywhere in the network, almost at the time of your own choice. Instead of being barriers to travel, transfers open up a large number of new travel opportunities. All lines and all modes of transport "feed" each other with traffic and increase each other's market share.

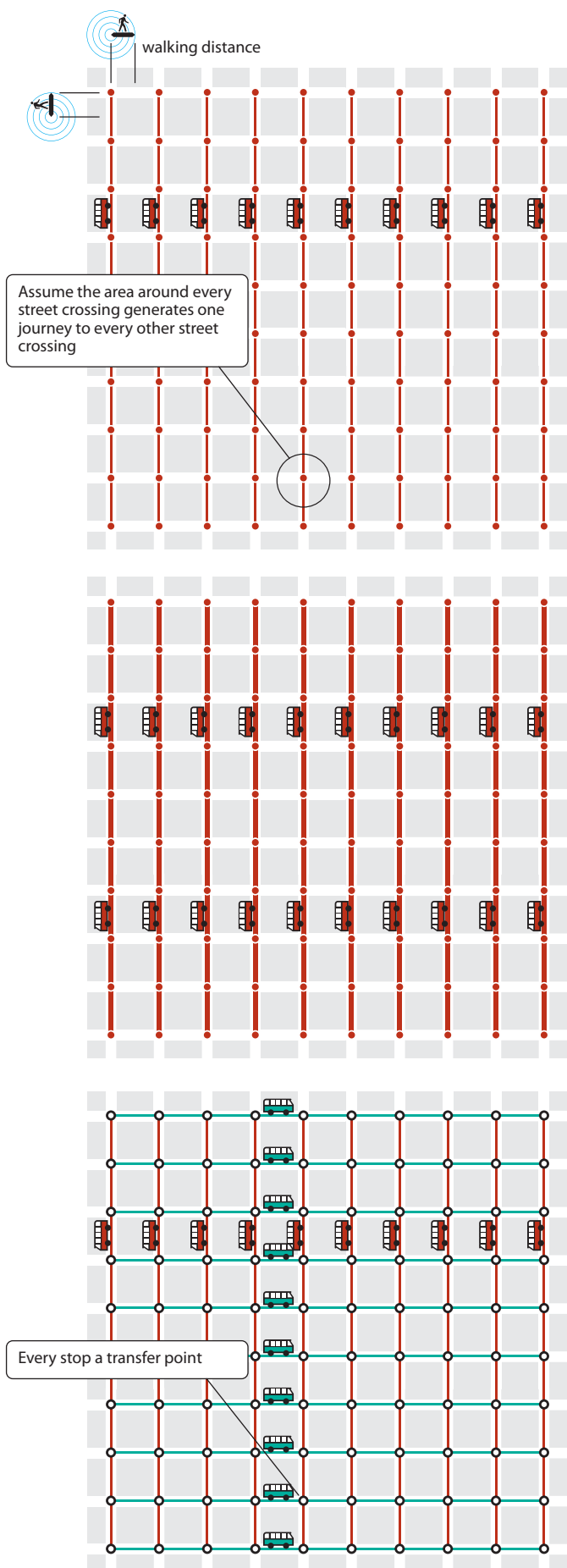

The network effect: the “Squareville” example

1 “Squareville” with ten bus lines running north–south

The hypothetical city of “Squareville” has a grid-iron street pattern. The streets are well suited for a bus service since they are 800 meters apart. “Squareville” is a homogeneous city with a travel demand that is entirely dispersed. Assume the area around each of the city’s street crossings generates one journey to every other street crossing; 9900 trips per day in total.

For the whole of “Squareville”, the ten bus lines can only serve 900 trips in the city, which is less than 10 percent of the total trips of 9900. Assume that the public transport service presently attracts one-third of the journeys it can theoretically serve. This gives 300 trips per day by public transport, which is a modal share across the whole city of only 3 percent.

2 “Squareville” with ten bus lines running north–south, double frequencies on all lines

Imagine that services on the existing bus lines are doubled in order to make more people in “Squareville” to use public transport. According to traditional transport demand modelling the elasticity of demand might be assumed to be some 0.5. This means that a 100 percent increase in service will produce a 50 percent increase in demand. The result will be 450 public transport trips per day and a modal share of 4.5 percent. Since the operational costs are likely to increase by more than 50 percent, the cost-recovery through fares is likely to fall.

3 “Squareville” with twenty bus lines running north–south and east–west

Imagine that the extra operating resources instead were used to run ten new bus lines in the east-west direction. This would create a grid network of twenty lines. The number of trips that are directly served would double to 1800; the 900 initial north-south journeys and the 900 new east-west journeys that can be made without transferring between lines. But if passengers are willing to transfer, then all 9900 trips between all blocks can be served by this network; 1800 directly and 8100 by transferring. Assume that the modal share for journeys involving a transfer is half of that for direct journeys, i.e. one-sixth of these trips that can be attracted to public transport. This gives a total number of 1950 public transport trips per day ($1800/3 + 8100/6$). The modal share has increased dramatically from 3 to 20 percent.

This gives an elasticity of demand that is 5.5, rather than the traditional figure of 0.5. Increased revenue from the fares should more than cover the extra costs of operation and vehicle occupation would rise.

(Adapted from Paul Mees, 2000).

The network effect is not limited to “Squareville”

- 1 The theoretical concept of Squareville: a grid pattern of high frequency lines where all journeys may be done with one transfer only. Very large cities and agglomerations may have the possibility to develop their public transport network according to this principle.
- 2 In many cities with a population of some 100,000–200,000 or more, the urban structure and travel demand might allow for one or two ring lines. If possible, the ring line(s) should have a frequency and travel speed that makes it attractive to travel across the city without having to travel all the way to the city centre. By developing high quality interchanges at strategic locations with a concentration of activities, a fairly attractive network may be achieved.
- 3 In smaller cities, including most cities under 100,000 inhabitants, most journeys are short, and the demand for public transport is insufficient to support a high frequency ring line outside the central parts of the city. Then all public transport journeys between different suburbs must be made through the city centre, either directly on a through running line, or by transfer in the city centre. A network effect may still be achieved if the service frequencies are high in all major corridors of the city region, and the interchange is a high quality one.
- 4 In smaller towns, the number of corridors with sufficient demand for high quality public transport are few, so here the coordination between regional and local lines will become more important for the possible creation of a network effect. The town centre is the only major interchange in the town in addition to the common stops of several lines in each of the transport corridors.
- 5 In even smaller towns and villages there is no basis for a separate local network. All public transport (except service lines, etc.) is based on the regional lines serving the rural district and connecting to the nearest larger town and/or transport hub. Here frequencies are so low that time table co-ordination is necessary to achieve a network effect in the regional system.
- 6 Time table coordination through the creation of integrated pulse schedules (see chapter 3.5) is even more important at bus or rail stations in areas where the frequency of services is low.

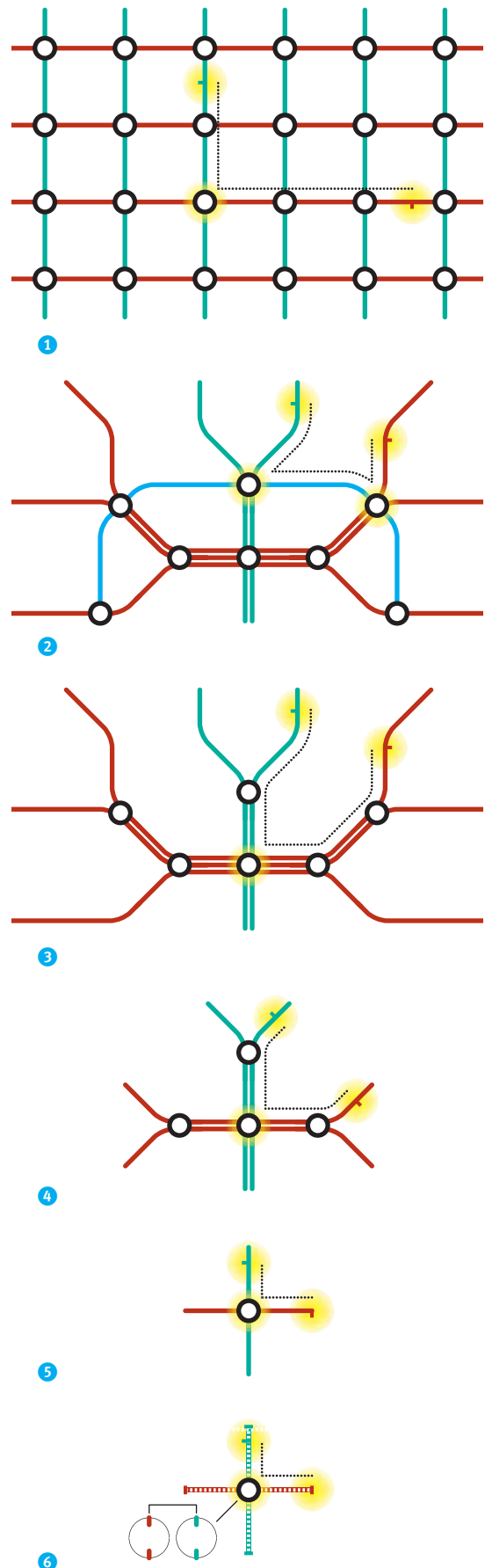

Comparing Good and Bad Practice: The cities of Toronto and Melbourne

A comparative study by Mees (2000) of the network structure in Toronto and Melbourne demonstrate the importance of network integration for public transport success. He has made a thorough study of the two cities' urban structure, transport and land use policies, urban densities, car ownership etc, in addition to comparing the public transport systems' infrastructure, service levels and patronage.

Some key figures from the two cities demonstrate that Toronto in the period 1960–1990 completely outperformed Melbourne in relation to public transport patronage, modal split and the changing market role of public transport and the motor car in the two city regions. This happened even as the car ownership developed at the approximately same rate in the two cities.

Mees studied the urban densities in different parts of the city regions, in particular the size of the population living near the (sub)urban rail systems, and the variations in public transport patronage in the different areas. By this he found that the main difference between the public transport patronage in the two cities was in the inner suburban areas of the city, and that the much higher patronage in these parts of the region had nothing to do with higher densities or better transport infrastructure. He studied the relative merits of the public transport net-

works and service levels in the two cities, and found that the main explanations for the relative success of public transport in Toronto, compared to Melbourne were:

- ▶ The high quality of bus services in the suburbs and their excellent integration with rail in Toronto, and the poor bus service and lack of integration with rail in Melbourne.
- ▶ The integrated system of Toronto also resulted in a much more intensive and cost-efficient use of the rail infrastructure, when compared to the more extensive Melbourne rail system.
- ▶ The bus and rail combination in Toronto proved more attractive to the population in Toronto than the more extensive park&ride facilities that had been developed in Melbourne, partly as a result of the poor bus and rail integration.

The conclusions were supported by the internal variations in patronage and service qualities in both urban regions.

The theory of the importance of the integrated, network effect for overall public transport patronage and competitiveness was shown to be a significant aspect in real world transport operations.

	Melbourne		Toronto	
	1980–81	1990–91	1980	1990
Population	2.7 m	3.0 m	3.1 m	3.9 m
Public transport journeys per capita	95	97	213	233
Change in p.t. journeys per capita 1960–1990	–56 %		+22 %	
	1964	1986	1964	1986
	Public transport share of all motorised trips	42 %	19 %	33 %
	1961	1991	1961	1991
	Car ownership, cars per 1000 residents	224	496	298

Challenging low demand situations and infrastructure restrictions

In practice, two different types of restrictions for the exploitation of the network effect are common.

In small cities, particularly in cities with less than some 100,000–200,000 inhabitants, the demand for public transport is often too little to support high frequency public transport services. At the same time, the problems of road traffic congestion and environmental problems are not (yet) perceived as serious enough to create a political will to use heavy public subsidy to finance high frequency services. A similar situation prevails in the outer parts of even bigger city regions, and in the rural hinterland of the cities.

In such low demand situations, it is crucial that the more modest services on different lines and modes are closely coordinated and integrated. Later in this chapter we will describe the pulse timetable approach as the major network strategy to follow. When the aim is to make a public transport system with ability to compete with the motorcar in the transport market, this type of approach is a “must”.

On the other hand, in some medium sized cities, e.g. with some 100,000–500,000 inhabitants, the high frequency requirements of several suburban corridors may cause congestion in the public transport system and require costly infrastructure building in central parts of the city. This has to some extent occurred in some European light rail cities where the capacity of the light rail system is restricted by vehicle and train size and street and track capacity, while heavy rail systems and underground tunnels are too costly for the transport demand in question. For instance, the success of the Karlsruhe tramtrain solution has led the city into heavy discussions of the building of a light rail tunnel under the city centre.

In larger cities and more densely developed urban regions the capacity problems of bus and light rail systems may be significant in the inner city and at infrastructure bottlenecks.

Also such capacity problems are most efficiently dealt with by integrated network development

where all modes and lines with their different capacities, infrastructure requirements and operational cost structures are considered.

Some lessons from Zürich – the benchmark city of public transport

In many international comparative studies, the city of Zürich stands out as the benchmark city of urban public transport in the western world. Both public transport supply and public transport demand are well above the typical European level for cities of a comparable size, structure and level of economic development (Vibe 2003, Schley 2001, Mees 2000, Apel and Pharoah 1995).

In 1998 the number of public transport trips per capita in Zürich was 531, which is almost 60 percent more trips than in the best German city, Munich, with 335 trips per capita each year (Schley 2001). In the central city, the citizens make more than two public transport journeys per day, and even in the suburbs more than 500 journeys are made per year. Zürich is reported to have the modern world’s highest rate of public transport usage after densely populated Hong Kong (Mees 2000).

Zürich is a city where even the affluent choose to leave their car and go by public transport. This is also reflected in a very high share of the transport market for motorised journeys made by the inhabitants of the city.

In most cities public transport has been losing in market competition with the car. In Zürich public transport has increased its position over the last 20–25 years.

There is an amazing difference in the development of transport demand in the two affluent cities of Zürich and Frankfurt. In Zürich, since 1970 per capita public transport demand has increased by 60 percent, which is more than the growth in motorisation. Public transport has increased its market share in the last 20 years. In Frankfurt, it is motorisation that has increased by 60 percent, while per capita public transport use has gone down by 14 percent (Schley 2000). A comparison of the development of car traffic in Zürich and Stuttgart in the period 1976–

Modal split in Zürich and some other cities

Public transport share of all motorised trips

Zürich	57 %	(1992)
Helsinki	40 %	(2000) "Huvudstadsområdet"
Frankfurt	39 %	(1998)
Munich	37 %	(1997)
Oslo	37 %	(2000) "Oslo & Bærum"
Freiburg	35 %	(1998)
Karlsruhe	27 %	(1992)
Gothenburg	24 %	(2000) "Göteborgsområdet"

Based on travel survey data among the inhabitants.

Sources: Schley 2000, Nielsen and Ringquist 2004.

Zürich vs. Frankfurt

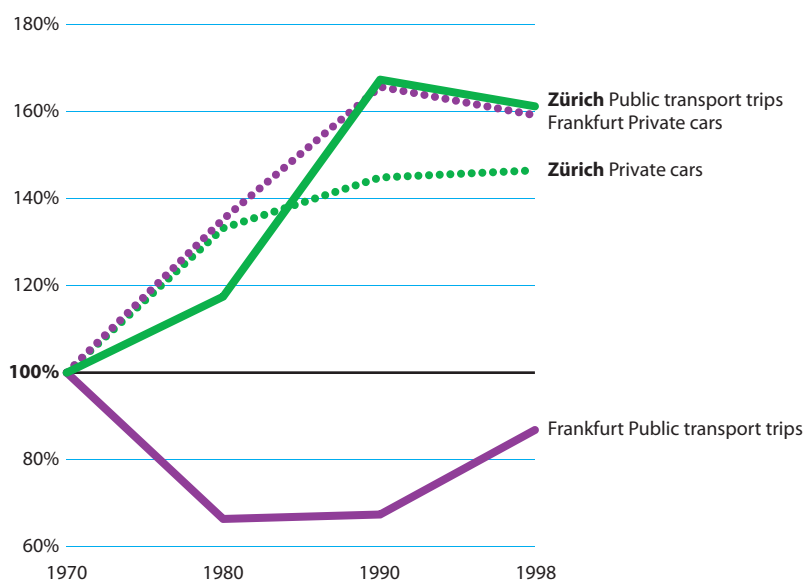

Changes in private cars per inhabitant and annual public transport trips per inhabitants in Zürich and Frankfurt 1970–1998.

(Schley 2000)

88 shows a similar difference between the Swiss and the German city (Apel and Pharoah 1995).

The increasing market share of public transport in Zürich is confirmed by the changes in the modal split of journeys to work for residents in all parts of the city region during the 1980s. Even when starting at a relatively high market share, from 1980 to 1990 public transport increased its share in the central city, in the suburbs, and in the outer parts of Greater Zürich (Apel and Pharoah 1995). This is contrary to the transport development in most other city regions in Europe, where suburban car traffic is growing much faster than public transport use.

The main explanation given in the literature for the competitive success of public transport in Zürich, is the city's (and region's) high quality of service and the insistence on keeping the high service level for many decades, and over the whole of the built-up area of the city. Some restrictions on car parking, pedestrianisation and little road building in the central parts of the city, may explain some of the difference in modal split compared to other cities. Also land use density, urban structure and topography are factors to consider. But it is more likely that the high standard of public transport provision is the major explanation for the results achieved (Vibe 2003, Schley 2001, Mees 2000, Apel and Pharoah 1995).

Analyses of the public transport network show

Access to public transport services in Zürich and Bochum

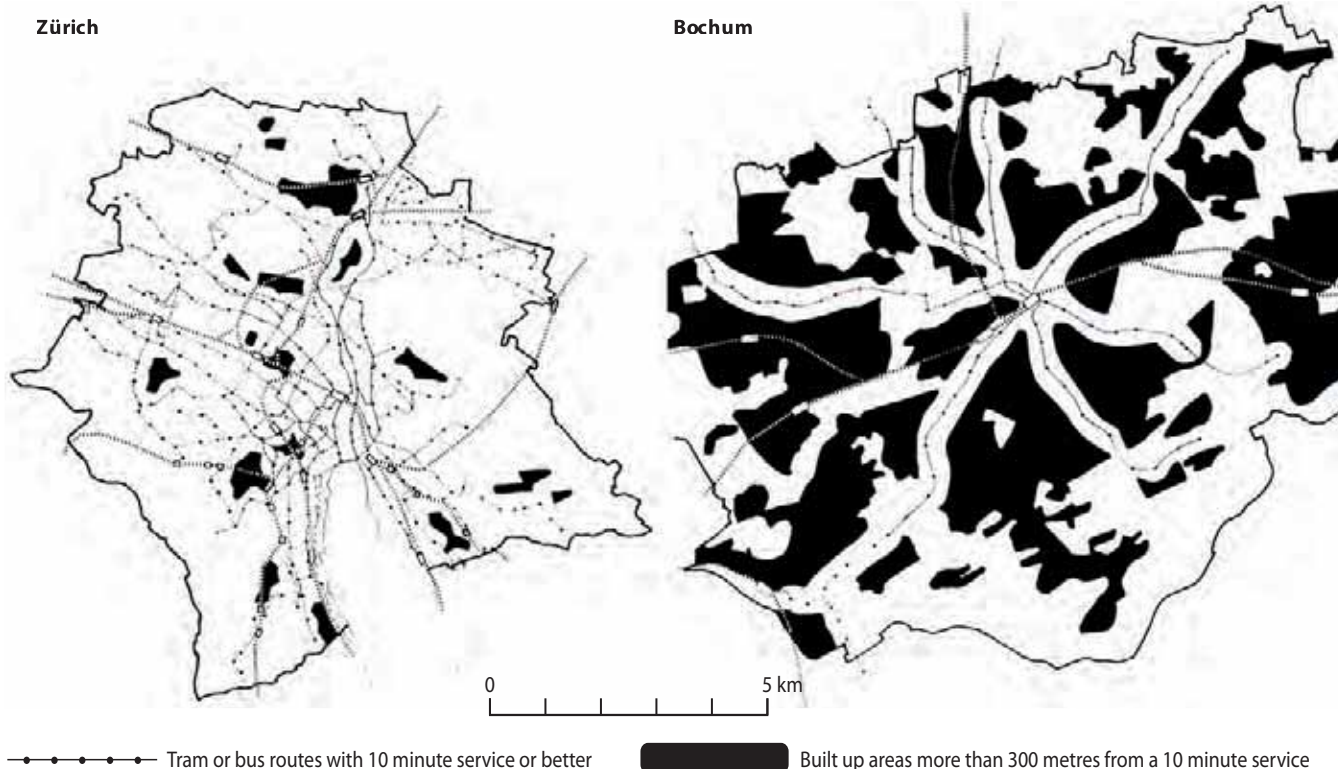

The maps compare the service levels of public transport in the cities of Zürich and Bochum, two cities of similar population and density. They show the extent of urban area in the two cities that is more than 300 metres from a 10-minute service or better. The service density indicators in the table show that the supply of public transport per unit of urban land in Zürich is more than three times that of Bochum.

	Zürich	Bochum	Unit
Network density	3.0	1.7	Km network per sq km
Line density	4.9	2.5	Km lines per sq km
Density of stops	5.6	3.8	Stops per sq km
Service density	2440	460	Departures from stops on weekdays per sq km
Total two-way service per hour			Average number of departures per stop
	408	92	- Peak hours
	294	85	- Off-peak hours
	177	41	- Late evening

(Apel and Pharoah 1995; maps courtesy of Willi Hüsler)

that the density of lines and the high frequency of services are key factors in the success of Zürich. The accessibility to high frequency public transport services is much better in Zürich than in other cities, as illustrated in a comparison between the public transport networks of Bochum (D) and Zürich. In Zürich more than half of the tram and bus lines run at 6 minute intervals, and this level of service has been in operation for 100 years.

Moreover, in Zürich the lines run in many directions, not only between a suburb and the city center. The lines form a proper network, and the high frequency means that waiting times at the large number of interchanges are short. In areas and periods where demand is too small to support high frequency services, the network is operated on an integrated "pulse timetable" ("integrierte taktfahrplan") where transfer time is minimised through the co-ordination of timetables of buses, trams and train services.

To achieve this, all modes must of course run according to the timetables. To achieve this, trams and buses in Zürich have full priority in the road system, and these priority measures have now been in operation for 30 years.

The speed of travel of buses and trams in Zürich is not exceptionally fast. But, as opposed to many other European cities, the reason for the relatively slow speed of operation is not delays and disturbances caused by other traffic, but the short distances between stops. In Zürich more of the operating time is used to serve the passengers with stops close to their destinations. In many other cities the same time is used to negotiate the inefficient traffic of the competing mode of transport.

A cross sectional, multivariate analysis of 43 different cities in the "Millennium database" of The International Association of Public Transport (UITP) confirms the view that Zürich (together with Bern, the other main city of Switzerland) has an outstandingly high service level in its public transport provision. But still, the city also has a reasonably high standard of provision for the use of motor cars, as measured in terms of road network qualities, driving

speed, parking provision in the city centre and costs of using a car (Vibe 2003).

The lessons from Zürich are:

- ▶ A high quality, largely rail-based public transport system can challenge the car as the dominant mode of transport in a public transport-minded city, even without having to introduce very strong restrictions or cost penalties on the use of cars.
- ▶ The main key to market success is the network qualities of the public transport system. It is the integrated, high frequency network with many interchanges, and the stable and reliable operations through several decades that makes the difference.
- ▶ Having retained and developed the tram and bus system in the streets of the city, and choosing not to build a far more costly underground system, is an important aspect of the success. But the full priority system for the trams and buses is an important precondition for this success.



The Zürich network 2004 (right) and legend (above).
Source: ZVV – Zürcher Verkehrsverbund: www.zvv.ch

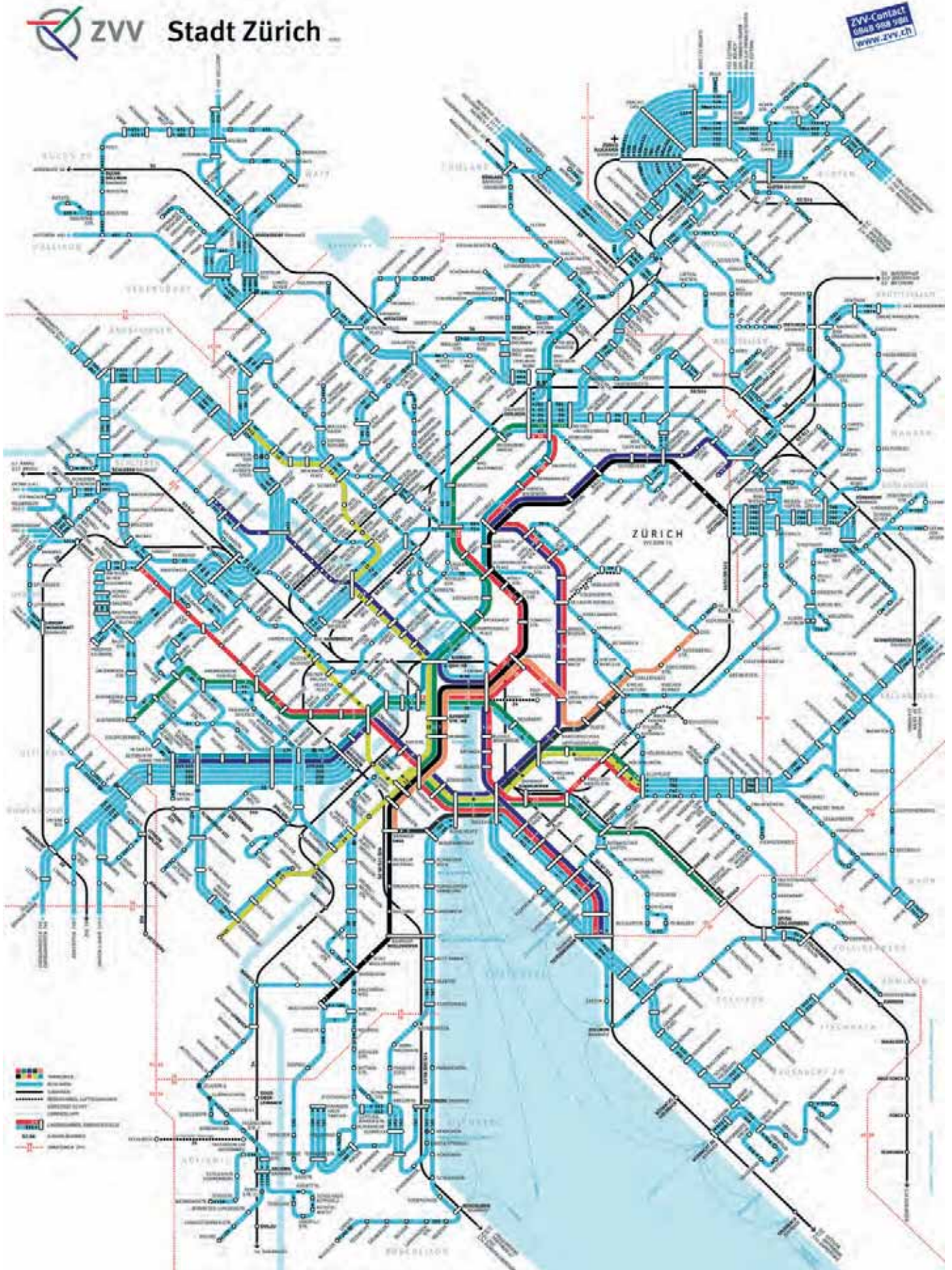

3.3 Defining the main elements

When designing the public transport network it is necessary to have some “rules” for the definitions of lines and the network of lines. These proposed specifications below are not absolute, and they may sometimes be in conflict with each other. The planner will deviate from them when it is necessary for practical reasons in local situations, and when there are clear and good reasons to depart from the principles. However, when there are no such reasons to make allowance for, the advice is to follow the “rules of the game”.

Simple lines with stable routes and fixed stopping patterns

Simplicity in the design of the main lines is a “golden rule” for the creation of a public transport system that is attractive and easy to understand and operate. If this rule is overlooked, as the case is in many urban regions, the system and its services become diffuse, and difficult to understand. The need for information about geography and timetables becomes a heavy barrier to users and synergies between different modes and operators are very difficult to achieve.

A line must have a timetable that should be as simple as possible. Under ideal operating conditions the driving and stopping times would be the same at all times. Then it will be possible to operate with fixed departure times at every hour during the service period. However, large fluctuations in demand, congestion and insufficient priority measures will in many cases force the introduction of peak and off peak running times. High frequencies will offset some of the disadvantage in the peak, but outside peak periods a fixed-minute (clock face) timetable should be the norm. Lines that are not operated in large parts of the general service period (peak services, night services etc) should not be included in the main network structure, but dealt with as a part of the supplementary access service.

“Line” vs. “Route”

This guide uses the term “line” and not the more commonly used English term “route”. By this we follow the GUIDE project (Tarzis and Last 2000) as well as the Scandinavian and Continental professional practice of distinguishing between the line as an operational element of the public transport system and the route that the bus or rail vehicle follows through the city. Normally in English, the terms route, operational route, service, etc. are used. But then it is easier to mix up our line concept with the other meanings of the word route.

Transfer, change and interchange

In this guide we use the verb “transfer” for the act of changing from one public transport line to another line that may be of the same or different mode of transport. Normally passengers transfer (or change) at a designated interchange. The noun “interchange” is used for all places in the public transport network that are specifically designed to facilitate transfers between lines and/or modes. Changes between vehicles may also take place at ordinary stops, but we designate stops as interchanges only when they offer clearly different travel directions and have physical facilities and information systems that support passengers when they transfer from one line to another.

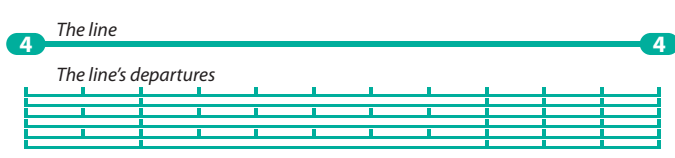
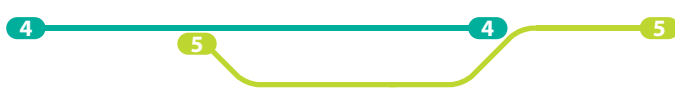
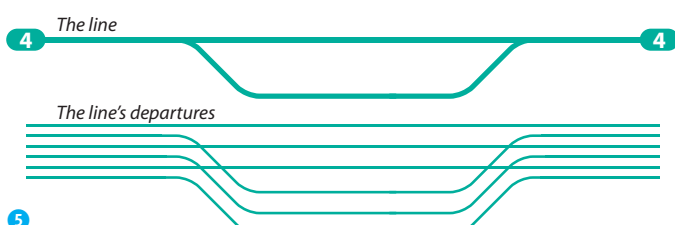
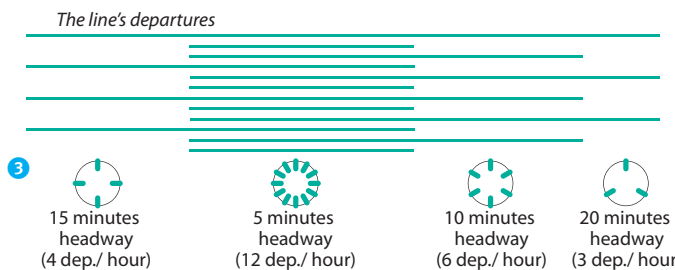
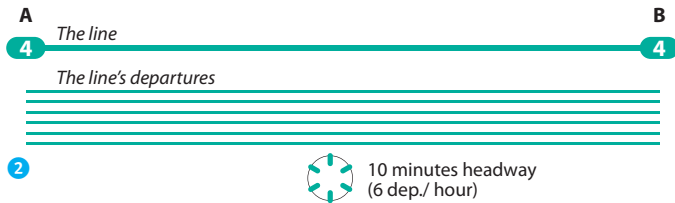

Properties of public transport lines

The line is the basic building element of the public transport network. Name, route, stopping pattern and timetables must be published in various forms. The line is the key to clear and concise information about what the public transport system can offer to the user, as well as the basis for operational planning of the service.

1 The line should have a name. The line should follow a defined route and have a fixed stopping pattern. The departures on the line should be according to a specific timetable.

2 **The ideal line** runs between A and B and all departures follow the same route and stopping pattern. In this example the departures on the line have a frequency of 6 departures per hour, with a 10 minute headway between departures.

3 **A line may have** different frequencies on different sections. This allows for the adjustment of capacity to varying demand along the line, without having to adjust or redesign the line geography.

4 If the market base along the route varies considerably, it will be better to divide the line into separate lines. Then the lines may be run by different types of vehicles resulting in more efficient use of capacity. Each line will then also have its own timetable, so that a section of the route may be without any service at certain periods.

5 **A line should not** follow different routes at different times or departures. The line becomes diffuse, difficult to understand by the public and difficult to inform about. Instead one should create more lines, for instance as illustrated here .

6 **A line should not** have different stopping patterns on different departures. The line concept loses its meaning, the service becomes difficult to understand. Instead one should create more lines with different stopping patterns. For instance, as illustrated here, line 4 is a full-stopping bus line serving all stops along the route. Line e4 is an express bus service with limited stops on the route.

Defining, naming and presenting lines to the public

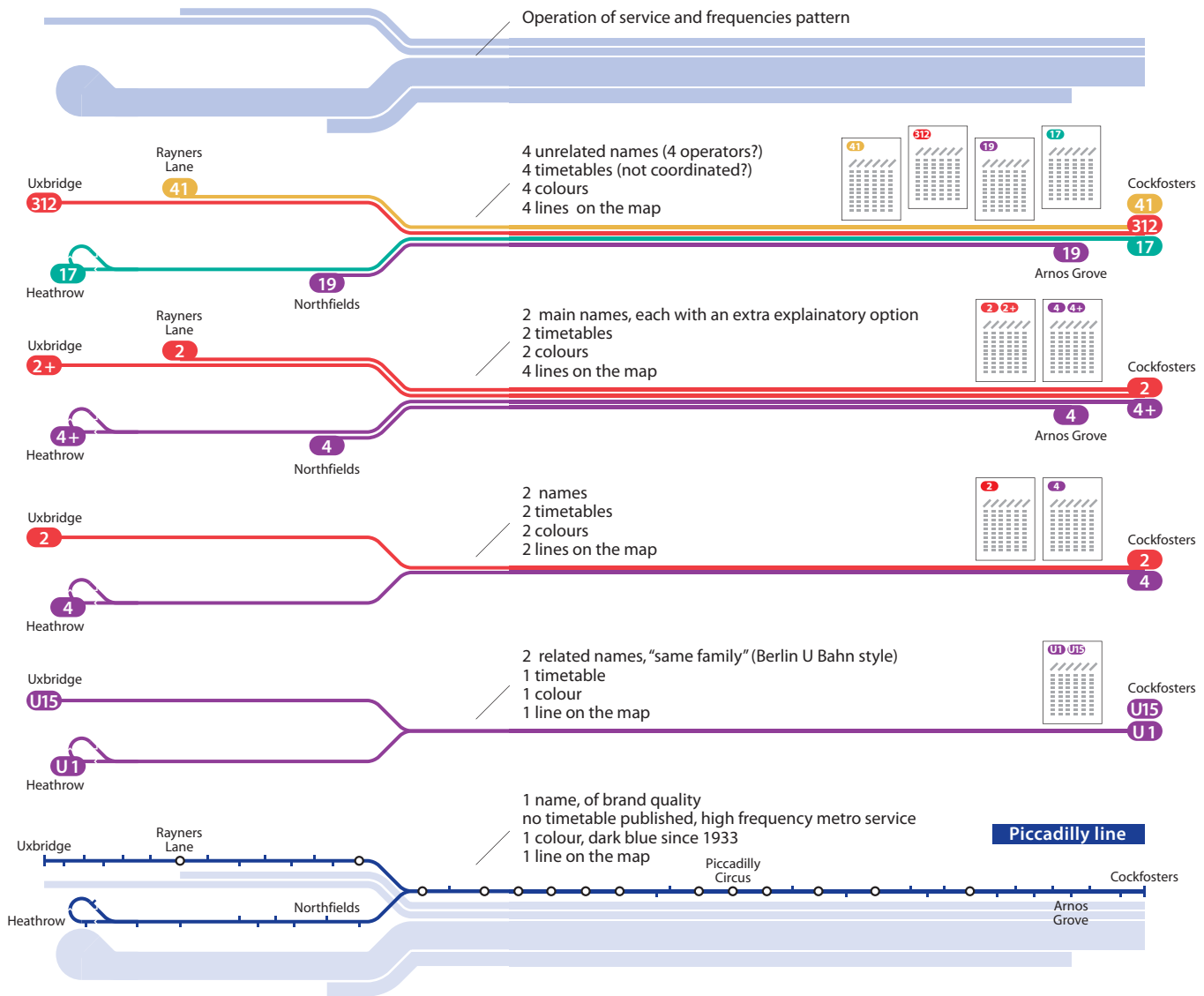

The actual operation of London Underground's Piccadilly line is presented here in four of many alternative ways. The examples – as well as the Piccadilly line itself – clearly demonstrate the

powerful options available within the concept of "a line" for presenting a service in a tidy, simple way which is easy to understand, sell and use. The example at the top shows the unsatis-

factory and quite common result of neglecting this. There is no real reason why simplicity and tidiness should be restricted to metro systems.

The use of frequency as a tool for flexible service adjustments

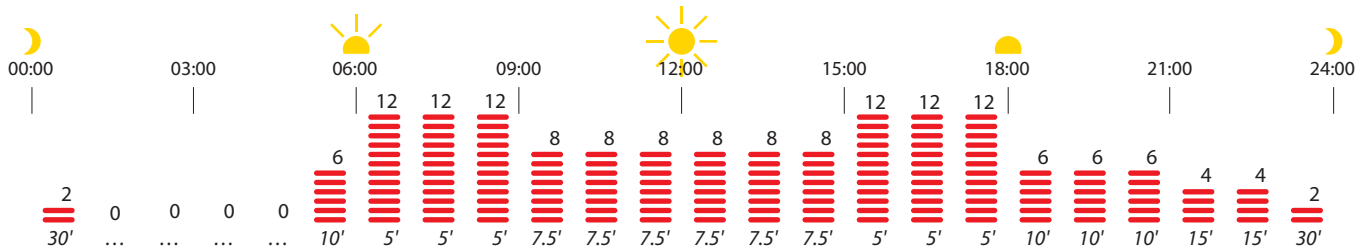

A tool for "fine tuning" supply

Frequencies can vary during the day, week and year. When departures are very frequent, there is little need for fixed-minute departure times. The user can freely take on their journeys with-

out checking the timetable. From an operational point of view, frequencies can be used as a means of adjusting the supply (and costs!) to the demand variations over time. This can most simply be done when the network is based on

the principle of "one line per route section". This is better than making adjustments in the line geography: "Line Y does not run after 18:00 and not on Saturday and Sunday", or "Line Z is suspended in the period June 20 – August 17."

Flexibility within classes of frequencies

The geography of the lines is the stable, structuring element of the public transport network. The frequency of the service on each line, above a defined minimum to be included in the main network, is the necessary, flexible tool for adjustments to demand variations and the level of economic support for the service that is available. And the frequency can vary both along the length of the line, as well as over time.

Despite the flexible approach to the frequency level, for long term network structure planning it will be useful to define specific "classes" of line sections in the network on the basis of their main frequency standard or service level.

The starting level for the classification might be the desired minimum service level that one is planning for in the long run. When two lines of that frequency level share a common stretch of route they will create a "double frequency" section if the two lines' timetables are coordinated. In parts of the region it is likely that demand density and economic support will not allow for more than "half frequency" in comparison with the principal objective for the service level. If necessary, this classification scheme can be extended both upwards and downwards.

One of the aims of the network planning should be to extend the area of the region that is served by full frequency services, and the number of inhabitants, work places and other travel destinations that can make use of "forget-the-timetable" feature of the public transport service. For this purpose several points about network design should be considered.

Try to obtain optimum frequency

Even if high frequency is an important prerequisite for market success, there is no need to "let the sky be the limit". There are clear limits to how many departures per hour one has to have in order to get short waiting times for the passengers. When we suggest 6–10 departures per hour at mid working daytime (and strengthened in peak periods) as a suitable frequency level to aim at for middle sized cities, this takes account of the fact that shorter headways would not radically reduce waiting times for the passengers. When this level of service has been reached in the main transport corridors of the city region, one should look for corridors of secondary importance that can make better use of the operational resources by increasing frequencies up the optimum level.

Capacity and local environment factors create another set of reasons for the setting of an upper limit

Three frequency classes – a simple planning device

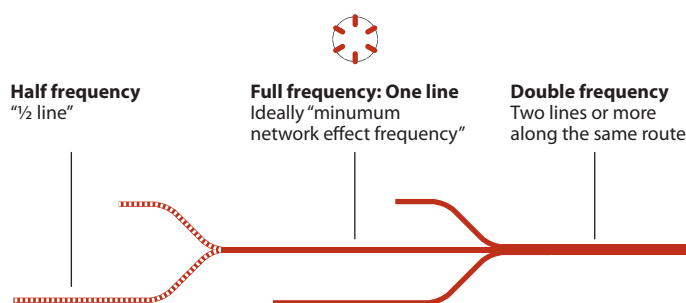

Full frequency: approx. 6 departures per hour as the basic work day service, i.e. headways of 10 minutes. These frequencies are strengthened in peak hours according to demand, if required only on sections of the lines carrying heavy traffic. This will be experienced by the users as a “forget-the-timetable” service. The time loss for transfers between lines will also be limited at this level of service, at least in peak hours.

Half frequency: Approximately half the number of departures per hour, i.e. headways of some 20 minutes. For these lines the users will prefer to know the departure times, and there is a clear need for timetable co-ordination in order to facilitate transfers between lines.

Double frequency (or better): This frequency will occur on sections of the network where two or more lines follow the same route. On these sections the users can forget the timetable most of the service period, and transfers can be made without much waiting time.

to public transport frequencies. Headways between trains, trams or buses often come down to 2 minutes or less in large cities and in networks with only one or two public transport corridors through the city centre. At this traffic density congestion starts to develop on rail lines and at stations, tram- and bus-stops. There are disturbances between vehicles, between boarding and ascending passengers and between buses, trams and pedestrians at level crossings. With separate right-of-way and segregation of

buses and trams in city streets, and strict traffic control in heavier rail systems, it is possible to operate the system at even shorter headways. But in general, long term planning should use design criteria that have some security margin for the occasional traffic fluctuations and small operational disturbances that will always be part of the daily operations of urban transport.

The normal strategy to deal with the congestion problems in city centres is to spread out the location of bus- and tram-stops. But this makes the system more complicated to use. The central interchanges, which have the best service level in terms of destinations and frequencies, become the worst places for the transfer of lines as far as walking distances, orientation, traffic and safety conflicts, etc. is concerned. Cities try to make heavy investments in their central interchanges, but very seldom manage to overcome the problems of a lack of physical space to incorporate the complex mixture of too many public transport lines and vehicles and people at the same time.

The alternative is to create a larger number of more moderate concentrations of lines and frequencies, and hence, a number of vehicles and passengers that are simpler to accommodate with style and comfort. This is likely to be a better alternative for the long term development of the public transport system in many large and medium sized cities.

The third factor that might help to define the upper limit for the optimum service frequency is considerations of the local environment and safety along the rail or bus corridors, mainly in the central parts of the city. These considerations may include factors such as traffic noise, local air pollution, traffic safety and barrier effects on crossing pedestrian and other traffic. For such reasons many cities try to limit the number of buses (and trams?) that are allowed onto the inner city streets, or they develop stronger restrictions on vehicle emissions than elsewhere in the region. In some cities, for instance Karlsruhe and Freiburg in Germany, such considerations have been decisive in the design of public transport systems

Desirable frequency – a balance between waiting time, congestion and costs of operation

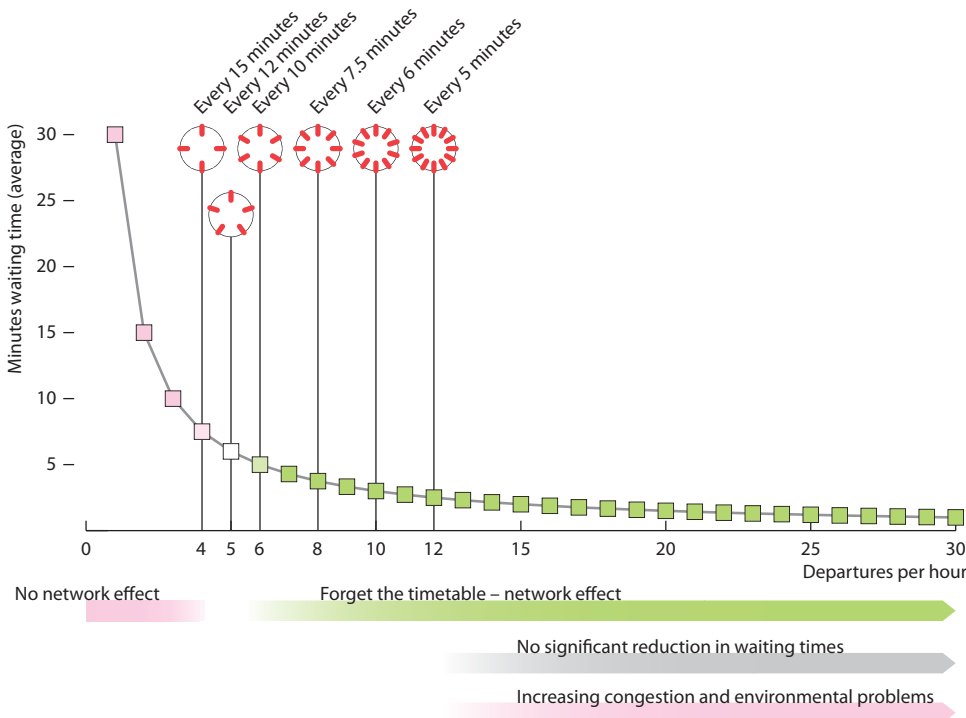

This diagram sets the average waiting time at half of the interval between departures. It suggests that a desirable service frequency for a major line would be approximately 6 departures per hour. Larger headways than this will give long waiting times, and a need to consult the timetable before the journey begins. Shorter headways will

cost proportionately more to run, but without giving significant reductions in waiting times. In addition, the tighter traffic may gradually cause increasing problems of congestion and environmental conflicts, especially if the line is operated by standard diesel buses in narrow streets in high density residential areas.

Too many buses can cause operational disturbances and environmental problems. Birmingham, England.

PHOTO: AXEL KÜHN

where there are almost no regular bus lines running through the city centre.

Improvements in the technology for vehicle power, fuel systems, and traffic safety and control, is likely to reduce several of the problems connected with high frequency public transport in city centres. The idea of the optimum frequency level will nevertheless be useful for the planning of the public network concept.

GOOD PRACTICE

Interchanges for "seamless" transfer in Freiburg



- 1 Main railway station.
- 2 Main junction in the pedestrianized city centre.

- 3 Suburban bus and tram interchange.
- 4 Park and ride interchange outside the inner city.

PHOTOS: GUSTAV NIELSEN

High quality transfer points and interchanges

The quality of transfer points is crucial for the creation of a public transport network that may function as a competitive alternative to car use in the urban regions, not only for the functioning of pulse timetable operations.

The difference in travel time, comfort and orientation effort between the really good and the far too usual, bad solutions at interchange point is very big. Therefore public transport users have very much to gain from high quality solutions at these points.

High quality interchanges at a large number of points is necessary to create the network effect that makes it possible to take full advantage of the simple line structure with few, but high frequency lines. If the critical transfer points do not function well, there will be a strong demand for more low frequency direct lines. This will result in a more fragmented, complex and continuously changing network of lines. The benefits of investment in rail infrastructure will be significantly reduced.

The strongest network effect will be achieved if well designed interchanges are developed at all places where two or more lines cross each other, so that transfers will create a number of new travel opportunities. Most of these points will be simple road junctions, so it is important that traffic engineering and management is strongly directed to take proper care of public transport users in the detailed design of urban streets and roads.

The largest transfer points will be major interchanges and meeting places between the public transport system and the urban land use structure. This will be regional and local centres of activity that combine the interchange function with being major traffic generators in themselves. These points will very often have high density concentrations of work places, commercial activities and public services as well as medium to high density residences.

GOOD PRACTICE

Safe and comfortable bicycle parking



Bicycle parking boxes for bike&rail in Strasbourg.

Bicycle parking and service at the station in Göttingen.

PHOTOS: GUSTAV NIELSEN

Quality access routes for everyone

In order to be competitive, the public transport system must provide a service that makes it possible for people to travel from all the way from origin to destination without hassle. The quality offered is no better than the weakest link in the travel chain. Therefore also the walking access mode to the public transport stops and interchanges must be seen as part of the public transport system.

The walking distance to the stops must be as short and attractive as possible. This is partly achieved by locating the stops at the right places near important travel destinations. It is also achieved by making the pedestrian routes accessible, safe and comfortable, protecting them from excessive noise, dust and air pollution, and leading the walking routes through interesting urban streets or beautiful parks, green corridors or natural environments. The more attractive the route, the longer distances people are willing to walk.

The requirement that even disabled persons should be able to use the public transport system cannot be satisfied by improving stopping places and vehicle access only. Also the access roads to the stops and on-the-road information must be without barriers and obstacles to wheel chairs, prams, those with reduced walking ability and impaired sight. The objective of universal accessibility for all users means that the details of the pedestrian network are important, including all year maintenance of the pedestrian network.

The bicycle can increase the catchment area ten times

For those with travel destinations more than a few hundred meters away from the bus or rail stops, the use of a bicycle or a car may cut down the total travel time.

The speed of travel by bicycle is 3–4 times that of walking. This means that, within the same access time to a rail or bus stop, the land area covered can be in the order of 10 times greater for a cyclist compared to a pedestrian. Comfortable and attractive routes for cycling to and from public transport

Interchange design principles recommended by the GUIDE project

Attribute	Principle	Commentary
Overall arrangement	Ideally locate services/ platforms where passengers can establish visual links from a number of different positions.	Easiest to achieve in surface/ elevated situations. Visual connections may be enhanced through use of glass walls/ roofs and similar materials.
	Locate facilities in logical progression for the principal user group.	Have facilities in sequence such as information/ inquiry desk, then ticket purchase, then service boarding point.
	Maximise sense of light and space, ideally using natural light.	Space is generally expensive, but floor area and/ or high ceilings create a higher comfort level for passengers than confined spaces.
Walk links	Minimise walk distances between service loading/ unloading points, platform entrances and street entrance.	But not at the expense of providing too little space for facilities such as waiting areas and the general comfort level for passengers.
	Minimise changes of levels, and avoid steps if possible.	Step-less transfer is difficult to achieve with multi-level interchange but provision of full wheelchair-access is expensive.
	Maximise directness of walking routes, avoiding changes in direction if possible.	Circuitous routes lead to passenger disorientation and anxiety ("am I going in the right direction"). Also security issues arising from "blind" corners.
Space management	Layout of spaces should facilitate efficient supervision by staff and maximise staff visibility to passengers.	Locate staffed points such as ticket barriers and information desks so as to maximise the area that can be supervised visually.

Source: Tarzis and Last 2000

GOOD PRACTICE

Cambridge Park & Ride



The city of Cambridge has had great success with a park and ride bus system for improved city centre accessibility. PHOTO: GUSTAV NIELSEN

stops will stretch out the catchment area of the system and make the bike-and-rail and bike-and-bus combinations more attractive as an alternative to the motorcar.

Safe and easy parking of bicycles at railway stations has been seen to stimulate the use of bike-and-rail. Many cities and countries are building bicycle service facilities also at light rail and major bus stops. To increase the use of bicycle infrastructure, they are also promoting bicycle use. This includes city bicycles and marketing activities to support more sustainable travel choices by citizens and organisations.

Access by car

Going by car is a well established access mode to and from rail and bus stops, and takes two basic forms:

- ▶ **Park and ride** is the usual term for journeys where the car driver (and accompanying car passengers) use public transport for at least one stage of the journey.
- ▶ **Kiss and ride** is the less used expression for another common way of accessing public transport services where the public transport passenger is collected and/or brought by a car driver in the family or elsewhere.

Park and ride require car parking places near the rail or bus stop. It is most successful in the market when a fast, frequent and high quality public transport service is combined with parking regulations and fees at the other end of the journey, normally in the city centre. Good access from the road system to the parking places is also desirable.

Often the park and ride facilities outside the city are provided free of charge to the public transport user (included in the ticket). But at stops in densely developed areas and more central locations, the cost of land and multilevel car parking will make this a less interesting option. A more cost-effective alternative may then instead be to use the area occupied by car parking to build more houses and concentrate transport-intensive functions near the stations.

Kiss and ride does not have the same large demand for parking space as park and ride, but

 GOOD PRACTICE

Houten – Transit town designed for cycling and walking



Houten outside Utrecht in Netherlands is a modern town designed to make public transport, walking and cycling the preferred transport alternatives for the citizens. Through town planning and conscious urban and traffic system design the planners have succeeded to create an urban settlement of some 28,000 inhabitants with 25 percent fewer car trips per inhabitant than average for Dutch suburbs (Meilof and Smit 1993).

The traffic system is created with short and direct routes for cyclists, no through traffic by cars, and the train station and town centre in the middle. A train-taxi service can be booked from an automat at the train station (top right), if the bicycle is not preferred as the main mode of transport to and from the station.

Source: Brochure from Gemeente Houten. PHOTOS: GUSTAV NIELSEN

generates approximately twice as many car trips per transferring public transport passenger.

However, when developing high quality public transport one wants to have as customers people with and without access to a car. Making car access a more attractive alternative must then be part of the total package of measures taken.

3.4 Creating the basis for a simple high frequency network

High quality and high frequency public transport networks cannot be developed without a sharp focus on the need for a simple and integrated network of high frequency services. This should be combined with a clear comprehension of the limitations of operational resources, vehicle- and man-hours in particular, and with an awareness of the network factors that affect the efficiency of operations. In the following sections, some main questions that must be dealt with for the design of the public transport network are discussed in this context.

Concentrate resources – be careful with new lines

When working on the improvement of public transport services from a user perspective, it is very easy to give a lot of attention to the lack of direct connections between different areas and destinations in the city region. Very often this leads to suggestions for a number of new lines as proposals for a better transport system – in addition to the existing services. However, it is important to take account of the fact that the resources for the operation of the public transport system are limited. A new line will very often require some reductions in other parts of the system.

It is necessary to balance the use of resources for the main line network against the need for serving local areas outside walking distances of the main network, and the need for solving the transport problems of the elderly and disabled that, for various reasons, cannot use the main line system.

The general network design “philosophy” advocated in this guide leads to the advice that the number of lines should be as few as possible in order to create an efficient, high quality main line system for the majority of public transport users. The expectation is that this will also leave more resources to provide an improved local access service system that is more sensitive to the specific needs of the elderly and disabled, and the people living in low density urban and semi-rural parts of the region.

Strategies for dealing with peak period capacity demand

The aim of offering a full-day high quality service means that one should attempt to have high frequencies over most of the daily traffic period. The strategies for dealing with the shifting demand, particularly in peak periods, will be different for the various modes of public transport.

Rail systems: In many cities capacity restrictions of the rail infrastructure limit the number of trains and the number of carriages per train that can be used to cater for the peak hour travel demand. The economics of the rail operations must be assessed in the specific, local circumstances. This assessment should consider, among other things, the extra costs of shifting the number of vehicles per train during the day and week, as well as the extra costs of urban land and rail infrastructure needed to stock and maintain a number of extra peak-period vehicles.

For rail systems in general it is desirable to make good use of the rail infrastructure and the relatively expensive rolling stock most of the service time. This means that frequencies should be high both in and outside peak periods, and that lines that do not have sufficient demand for a reasonable frequency should be converted to bus or a lighter rail system.

The traditional design responses to the capacity challenges in rail systems are longer or two-level trains and flexible seating designs of the carriages, to allow for extra standing and folding seat passengers in spaces that may be used for prams, bicycles, wheelchairs or luggage outside the peak periods. This strategy contributes to an improvement of travel comfort and service quality outside peak periods.

As long as the frequency and train lengths are fixed, there is very little extra cost per new passenger at off peak. Since demand elasticities are likely to be higher than at peak periods, this seems to be a commercially very sensible strategy. The combined effect of improved comfort outside peaks and the full-day high frequency service will be a more even demand for public transport over the day.

Bus systems: Even the bus systems can use a similar strategy in vehicle design, catering for more

Concentration of resources – a prerequisite for high frequency services

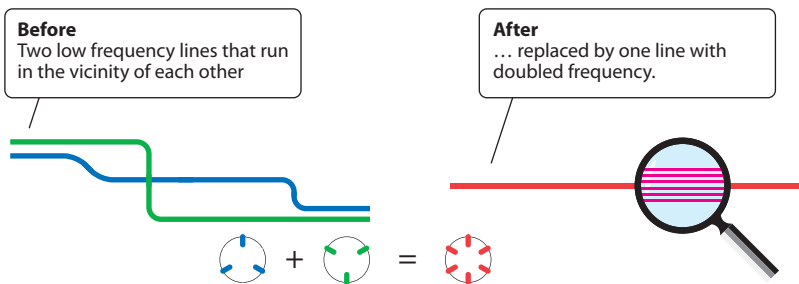

Lines that run at low frequencies in the vicinity of each other, serving much the same customers and travel destinations should be gathered together as follows.

Two lines with three departures per hour are replaced by one line with six departures per hour. The benefit is high frequency as well as a transport service that is easier to understand and remember, and simpler to use. The theoretical, average waiting time is reduced from 10 minutes to 5 minutes. The price the user must pay is increased average walking distance and a reduction in direct travel links.

The concentration of lines may, however, also create new opportunities

for improvements of the new main route. With the concentration of public transport passengers and vehicles, measures that speed up the journey, give priority to public transport at the expense of car traffic and improve the standard of stopping places, may become much more profitable. Together with the shortening of routes travelled this will both reduce running costs of the service and make the system more competitive.

The concentration of service to a single, high quality line is also conducive to the development of network interchanges that one cannot think of when the lines are dispersed.

standing passengers for short, local journeys in the peak hours. But this is limited to city traffic and local feeder services. For long journeys and buses running at high speed on motorways, standing passengers are not an acceptable standard for system design.

Due to the nature of urban and regional travel demand, not all of the peak traffic can normally be catered for by the above rail and bus vehicle strategies, even if one introduces more efficient peak period pricing for public and/or private transport. In small towns and regions that fix their general service frequency at a very high level, there might be sufficient capacity to take all peak travel demand without any extra resources, perhaps excepting school buses. But normally there will be an extra peak demand that must be transported by bus.

The marginal extra cost per passenger for the peak bus services will be less than what had been the case if they were run as rail services. Therefore, in many regions it will be suitable to run peak period bus services in areas that are also served by a rail service that is running at its capacity.

Increased frequency should be the main solution to the demand for more capacity on bus lines in peak periods, since this improves the service to the public. Doubling of departures (two buses running together) is a flexible solution for the adjustment of capacity to instances of fluctuating demand and operational disturbances in other parts of the transport network. Still, it is desirable that most of the supply is presented as regular services in the timetables and public information.

Avoiding unnecessary transfers between lines

When developing a public transport network for the whole urban region, it is necessary to make arrangements for easy transfers between different lines and modes. However, the need to change is a significant inhibitor to travel, and should be avoided if it is possible, bearing in mind the limited operational resources and other considerations mentioned in this guide.

The most important measure that can be taken to reduce the need for transfers, is to create long lines that connect important travel origins and destinations such as densely developed housing areas, local and regional centres, concentrations of work places, etc. By connecting two such lines in a well designed interchange, a significant additional part of the region can relatively easily be reached by one transfer only. Two groups of long lines crossing each other may in theory cover all origins and destinations in a region by a combination of direct journeys and journeys with one transfer.

In practice, the solution will not be so simple. Urban form and development, topography and infrastructure will force modifications of the network. The public transport system has several modes and lines with different stopping patterns to cater for the different demands of the short and long distance travellers. Very different capacity demands in various parts of the region also require the splitting up of the network into different types of lines and modes.

Public transport is ready-to-use, not tailor-made transport

The theoretically extreme use of the "direct line" strategy for network design would be to offer a direct service between all combinations of origins and destinations in the region. In practice, it is only possible to offer direct services between small selections of travel relations in an urban region. Public transport is a travel service where the basic idea is to make use of economics of scale by offering people a choice of travelling together on predefined transport services. Attempts to offer tailor-made transport

similar to the individual use of the motor car cannot succeed.

The initially very laudable idea of making as many direct lines as possible between all ("important") destinations in the region will in practice very soon come into conflict with another reality factor: the limit to the resources available for operating the public transport network. As we will show in the following sections, this means that the direct line alternative is not always the best choice for the users of public transport. The opposite is more likely to be the case.

It is more fruitful to look upon the role of public transport as similar to the role of the road network in the city: the task of public transport is to provide access to all parts of the city region for all those who cannot or prefer not to use their own motorised transport, at the time of their own choice.

Many direct lines create a complicated network for users

A comparison of the "direct line" strategy with the "one section – one line" strategy shows that the first principle tends to lead to a network that is more complicated for the users, more complex to plan and operate and more vulnerable to operational disturbances. As long as the operational resources are the same, these disadvantages are unlikely to be offset by the benefits of more lines that offer direct travel opportunities without change. In addition, the aim of a long term stable network is very difficult to achieve.

The theoretical example (right) looks from a user point of view at how one may operate two radial corridors crossing each other. In relation to waiting time, the only advantage of the "direct line" strategy is that diagonal journeys between certain branches of the network may be made without transfer, if the user is able to learn the timetables and adjust her/his activities to this. But this is achieved to the disadvantage of the high frequency for journeys between other areas at either side of the interchange or city centre.

In the real world, line structure and timetables will be designed so as to give the best direct and

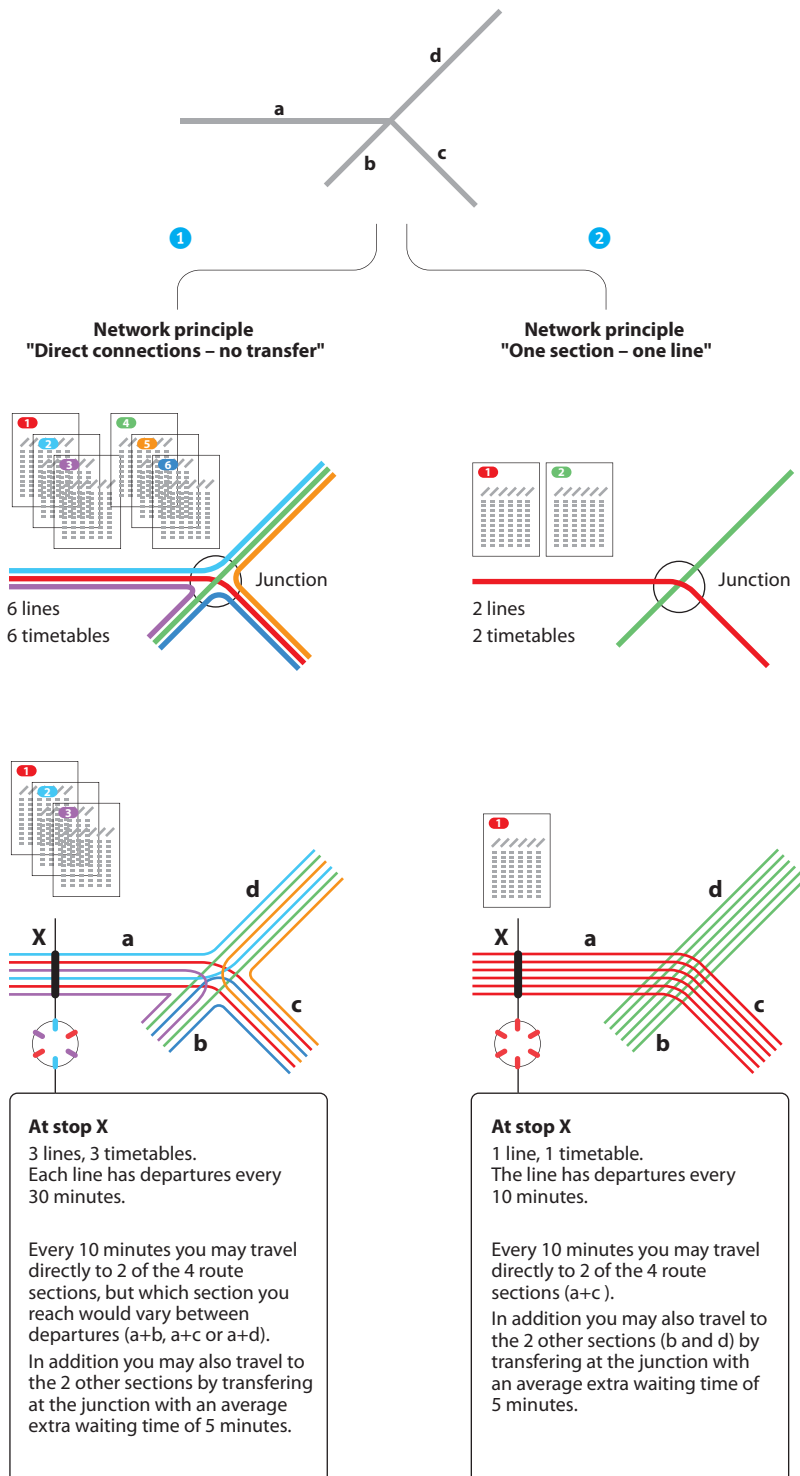

Two contrasting network principles

Few, high frequency lines instead of many direct lines

Example

Four areas (route sections a, b, c and d) to be served by two alternative network principles, 1 and 2.

The first principle is based on the idea that you should be able to travel directly from all sections to all other sections without transfer. The second principle is based on the idea that the network should be as simple as possible, and that transfer may be acceptable. The same operational resources are available for the two network principles.

1 "Direct connections - no transfer"

6 lines, 6 timetables.

6 lines with departures every 30 minutes.

2 "One section - one line"

2 lines, 2 timetables

2 lines with departures every 10 minutes

The only advantage of network 1 is that on diagonal journeys (a-b and a-d) you can travel directly without transfer if you are willing to study the timetables and plan your journey with the necessary adjustment in departure or arrival to fit the timetables.

However, this is achieved at the cost of the quality of the service on radial journeys (a-c and b-d), which have an increased frequency in network 2.

If you go along travelling without consulting the timetables, the average waiting times in the two networks are equal.

The example clearly indicates that the widespread belief of direct connections offering a higher quality service is not necessarily correct. It only favours the group of travellers who have much time to spare for journey planning and to adjust their departure and arrival times. It is unlikely that this group of travellers represents the majority of the market.

The "One section - one line" principle offers simplicity to all users.

high frequency services to the opposite travel corridors, so that transfers will only be necessary for the less likely combinations of origins and destinations.

This simple example does not take into consideration the extra burden for the traveller of having to transfer, which is significantly larger than the value of the extra waiting time for the second part of the journey. This topic will be further dealt with in a separate section.

However, when choosing between network strategies, there are also important operational considerations to make. After a brief study of this aspect of network design, we can see more clearly that the "one section – one line" network strategy has very real advantages in that it creates a much simpler and much more stable public transport network for the users. This is important to achieve the positive effects of the public transport network on peoples' long term travel and location decisions, as well as land use.

A complex, multi-line network is difficult to operate

One evident effect of the "direct line" strategy is that operational disturbances on one of the sections cause more disturbances in the rest of the network. When a departure on one line is delayed, this quickly affects frequency and passenger demand on other lines on the same section, which propagates further to other parts of the network. Since in practice all operational disturbances cannot be avoided, this happens very often in the real world urban areas with complex networks.

When route sections are served by several lines that run to different areas, there are problems of timing the departures on different lines. Even if there are many departures per hour on a route section, very easily big "holes" develop in the timetable for the common section. This results in longer waiting times for many passengers, and often uneven use of the capacity of different departures, i.e. less efficient use of the operational resources.

In bus operations, where the supplied capacity per departure is small, the uneven timetable on the

Network principle
"Direct connections – no transfer"

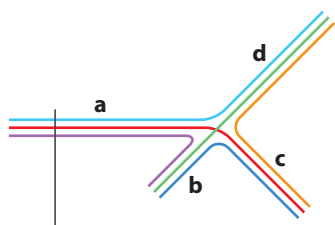

Desirable pulse timetable:
Intervals 10 –10 –10 –10 –10 on all sections, 6 departures per hour.

In practice the desired high and even frequency is very difficult to achieve, due to the dependencies created by the line structure. On section **a** Red line should be timed with Light blue and Violet line. But on section **b** the Violet line should also be timed together with Green and Blue, which in turn should be timed with Red and Yellow lines on section **c**, etc.

When the turnover time for the vehicles is different for each line operating on a common section, it will often be impossible to achieve equal headways between departures, even in theory. The result may, for instance, be 5–7–18–5–7–18 minutes.

With small delays on one line, this may easily lead to the creation of "convoys" of vehicles. Two departures will arrive at the stop at the same time. What should have been 6 departures per hour is reduced to 4, and they also come at irregular intervals, for instance 0–7–23–0–7–23.

Network principle
"One section – one line"

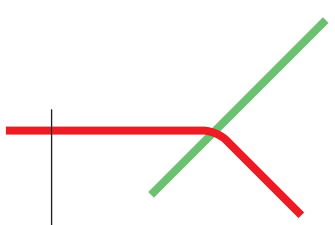

Desirable pulse timetable:
Intervals 10 –10 –10 –10 –10 on all sections, 6 departures per hour.

The desired pattern of departures is easy to achieve, because the frequency of the section is the same as for one single line.

Few, high frequency lines instead of many direct lines: Easier to plan and operate for high frequency and efficiency.

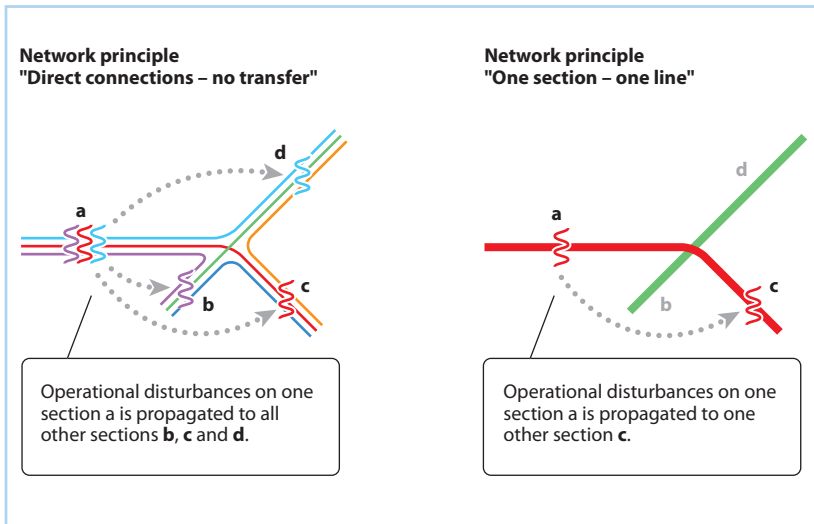

Few, high frequency lines instead of many direct lines: Less vulnerable to operational disturbances.

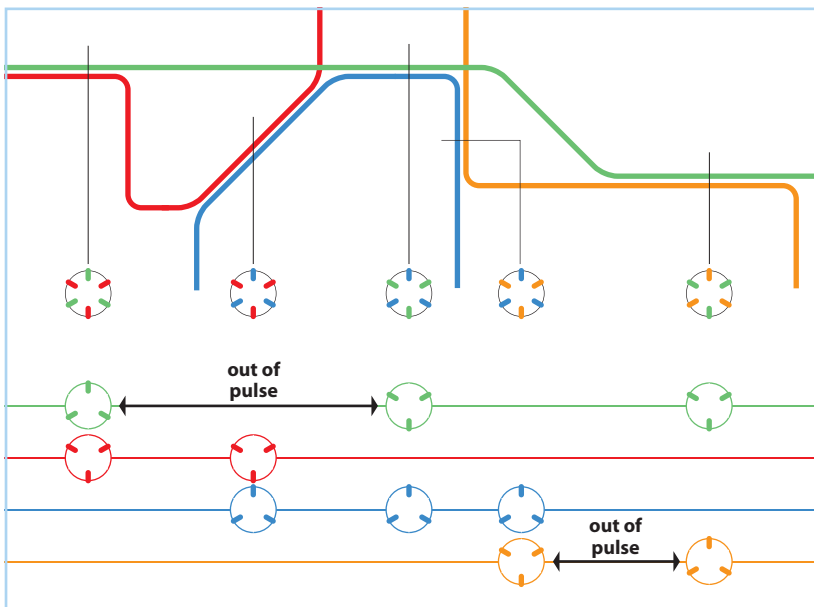

Many multi-line sections create interdependencies that are barriers against using operational resources to create proper high frequency services.

common route sections often lead to the creation of "convoys" of vehicles. This causes congestion and delays at bus-stops and often confusion among passengers about which bus to board, passengers running to catch the right bus, etc. This pattern is difficult to avoid when buses run from the same stops on different lines to different destinations. If there is only one line per route section and bus stop, it is much easier for the buses to assist each other through bypassing one or two stops. Normal operations can be much faster restored.

The problem with departure timetable pulse and stable frequency is not restricted to situations where there are many direct line connections, as in the example above. The more common route sections we make, the more interdependencies we have and the more difficult it will be to design a network where the operational resources can be used to produce real high frequency services. The long common route sections also make more difficult the fine adjustments of frequency against demand for each line that are necessary to optimize the use of operational resources.

The "one section - one line" principle is robust and flexible. Still, the use of this principle should not be exaggerated. It might lead to too many short lines, and this can result in too many forced transfers between lines as well as a less efficient operation. In many practical cases some common route sections for different lines will be the best solution, but only when there are some definite reasons for departing from the "one section - one line" principle.

Fewer lines on common route sections – more resources to the network

Example before restructuring of network

Six lines, each with 20 minutes headway and a common route section that has approximately the double length of each branch section.

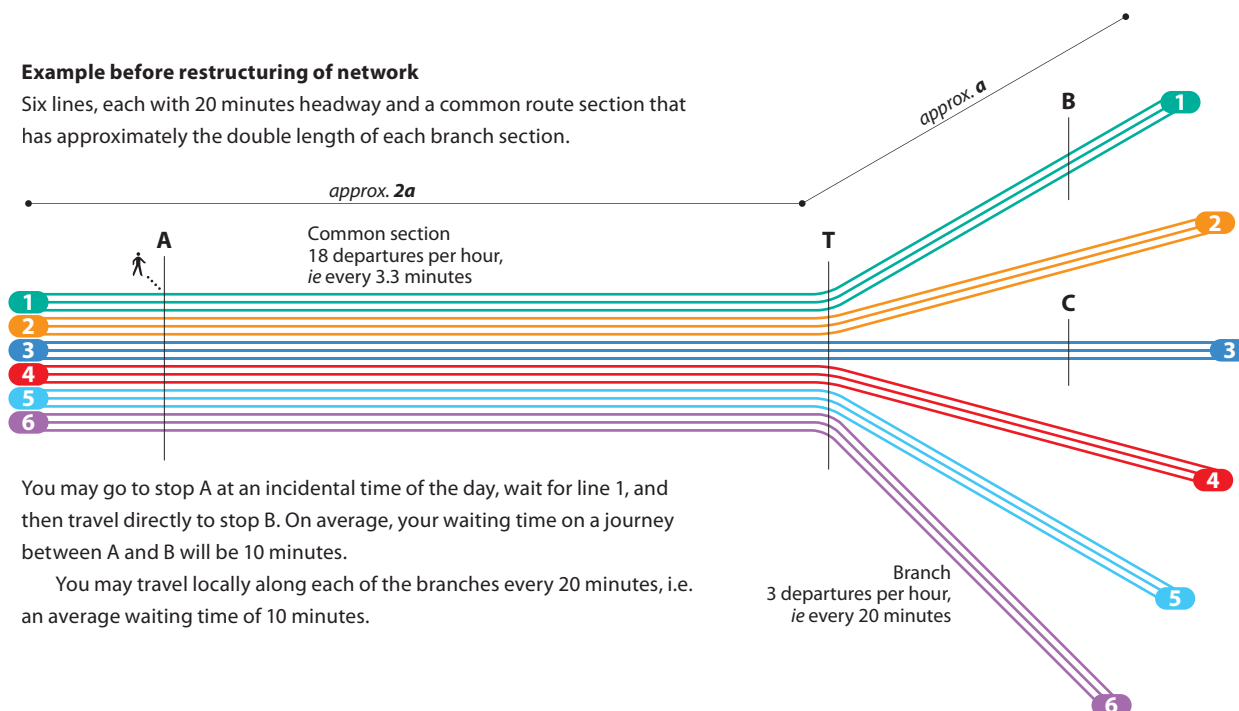

You may go to stop A at an incidental time of the day, wait for line 1, and then travel directly to stop B. On average, your waiting time on a journey between A and B will be 10 minutes.

You may travel locally along each of the branches every 20 minutes, i.e. an average waiting time of 10 minutes.

Example after network restructuring

Redesign the network structure and move the operational resources (vehicle hours and man hours) from the common section to the branches, but without increasing the resources used.

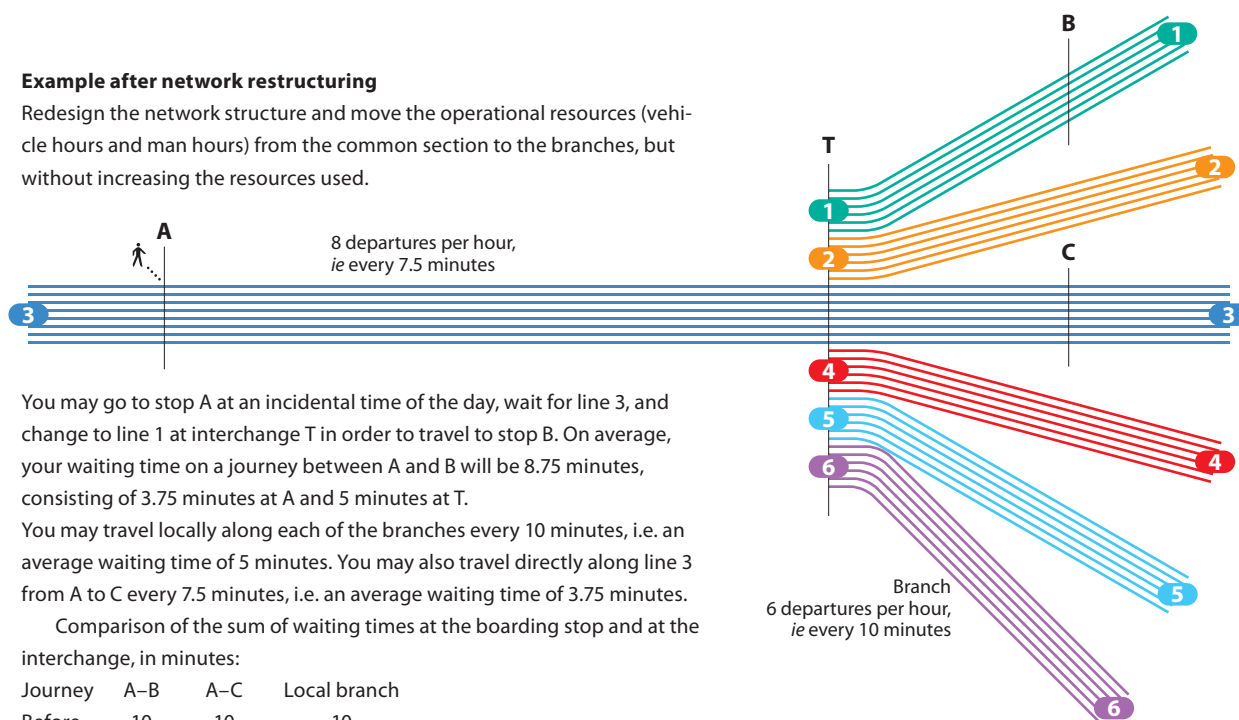

You may go to stop A at an incidental time of the day, wait for line 3, and change to line 1 at interchange T in order to travel to stop B. On average, your waiting time on a journey between A and B will be 8.75 minutes, consisting of 3.75 minutes at A and 5 minutes at T.

You may travel locally along each of the branches every 10 minutes, i.e. an average waiting time of 5 minutes. You may also travel directly along line 3 from A to C every 7.5 minutes, i.e. an average waiting time of 3.75 minutes.

Comparison of the sum of waiting times at the boarding stop and at the interchange, in minutes:

Journey	A-B	A-C	Local branch
Before	10	10	10
After	8.75	3.75	5

Even if one allows for any time (if needed) spent on changing platforms, this example suggests that total travel time does not have to increase, even if travellers have to make more transfers in the system.

Choosing between direct and feeder lines

A classic topic of discussion is the choice between direct lines to the regional centre or a combination of feeder and radial lines with interchange at a smaller centre or local hub.

The main argument normally put forward in favour of the direct line approach is that bus passengers have a strong resistance to transfers, due to the extra time and inconvenience of having to change modes in the middle of their journey. In many cases the introduction of a forced transfer will make the users switch to the car instead of travelling by public transport. Often it is also claimed that the direct bus solution is cheaper and more flexible to operate than a combination of local feeder bus and a rail service to the regional centre.

The normal objections to the direct bus solutions are that parallel running of bus and rail into the regional centre is a waste of resources due to under-use of train and rail capacity, that too many buses create congestion and environmental problems in the city centre, and that the journey by direct bus is slower and less comfortable than the alternative train journey on the main leg into the centre.

The main argument in favour of the feeder solution are that this system creates a more integrated network with better local travel opportunities by the transfer of operating resources from parallel bus and rail operation to a more economic division of roles between bus and rail. It is also pointed out that travel speed on rail is faster, more comfortable and more reliable than buses on the main roads into the city centre, and that the upgrading of the bus system in the corridors into the city centre is difficult and costly compared to the operation of trains on segregated rights-of-way. It is also claimed that feeder services are needed to make good use of the high capacity of the train system and support high frequency services in the main corridors. A feeder service can often provide a more frequent and useful local service and thus generate more local journeys if there is potential in the market.

Similar arguments may be used in the discussion of feeder lines to trunk bus services as to rail services,

Caveat:

What about the passenger capacity of the earlier common route section?

The restructuring in this example cannot be made without checking that capacity is sufficient in all parts of the network. In this type of network structure it is common that the critical capacity is not on the common section, but on the inner parts of each of the branches. The branch traffic determines the capacity need of each (branch) line, and the restructuring of the network reduces excess supply on the common section. The new structure also gives the option of running different classes of vehicles or different public transport modes on some of the branches. In the restructured example, line 3 might be run by trams or large, articulated buses, and the other lines with standard buses. Before the changes, the same vehicle had to be used for both the common section and the branch section of the same line.

GOOD PRACTICE

Jönköping's "KomFort" project: "Think tram – use bus"



Jönköping, on the southern shores of lake Vättern in Sweden, is a city with 81,000 inhabitants (including the integrated town of Huskvarna) and 120,000 in the administrative commune of Jönköping. In the summer of 1996 the city launched an initiative that reshaped the public transport system in the region through an integrated set of measures.

A completely restructured, modernized bus network was introduced. The network is now organised around three main pendulum lines that cross the urban area. All other lines have many connections with the main lines, which are the "arteries of the network".

The main routes (the "City buses") have been developed according to the principle of "think tram – use bus" by creating short, direct, fast and punctual bus routes all the way through the built up area. This is achieved through a consistent use of all available measures, such as traffic management, new bus only road links, dedicated bus lanes, signal prioritisation at street crossings, optimised locations of bus stops with

modern equipment and real time information to passengers based on GPS technology.

New, low floor articulated buses with four wide doors (two for embarking passengers, two for disembarking), electronic ticketing and a simple fare system contribute to the fast, comfortable and reliable travel by bus in Jönköping.

The fast and efficient operation of the main routes attracts so many passengers that the services are run with 5- and 10-minute intervals most of the day. This also induces many suburban passengers to make transfers between local and main line services for journeys within the city. Most of the local bus lines have two departures per hour most of the day.

Express and regional buses feed the main rail terminal and there is coordinated scheduling for the first and last daily departures. The fare system is integrated within the county. The integrated bus and rail terminal in the city centre gives all travellers access to transport and tourist



information services, waiting and cafe services. It also holds the city's local authority information centre. The design of the central terminal ensures close physical proximity between bus berths and rail platforms.

The results have been impressive. Patronage has increased by 15 percent (1996–2002) where it had been declining by a rate of –1–2% on an annual basis prior to the launch of the program. Comparable Swedish cities without a similar network restructuring continued their decline in the same period. The market share for public transport has increased from 19% to 22%. The level of patronage is higher than most comparable cities; 143 journeys per inhabitant per year is much more than most similarly sized cities in Scandinavia. The fare box recovery ratio is 68 percent (2000) compared to 32% in 1986 and up 13% since 1996.

Sources: Council of European Municipalities and Regions 2003, Marie 2001 and study visit by Civitas. PHOTOS: GUSTAV NIELSEN

but the argument tends to be more heated when the alternatives also imply that different operators are losing or gaining business opportunities in the market.

The importance of the network effect for overall public transport use has been stressed earlier in this chapter. But obviously the best answer to the problem depends on a number of considerations and local circumstances. For short journeys, the forced need to transfer is a substantial disincentive to use public transport. For longer journeys, the best solution for the user depends on a number of factors:

- ▶ Are there any time or cost savings or changes in comfort by choosing either the transfer or direct line service?
- ▶ How punctual and reliable are the different alternatives?
- ▶ How is the interchange designed? Is there a direct and coordinated five-step distance provided protection from the weather in a clean and nice environment? Or is it a more typical low status, uncomfortable and complicated interchange point, possibly also demanding the crossing of car traffic and the negotiation of stairs and lifts?
- ▶ What are the service frequencies of the different alternatives, both at peak hours and in weak traffic periods?
- ▶ How are the system design, information and ticketing systems; simple and easy to understand and use, or complex and without through ticketing?
- ▶ What sort of place is the interchange? Is it a simple bus or train stop with no extra services or is it a major service and employment centre?
- ▶ Are there other important travel destinations on the same local feeder lines?

Research into the perceived travel penalty for the users due to interchanges has given some interesting results, and studies of stated preference tend to give different results from studies of revealed preferences or actual travel behaviour. Users with experience of high quality interchanges have much smaller resistance than those direct bus users that are asked of their reactions to forced transfers.

GOOD PRACTICE

Copenhagen bus network redesign

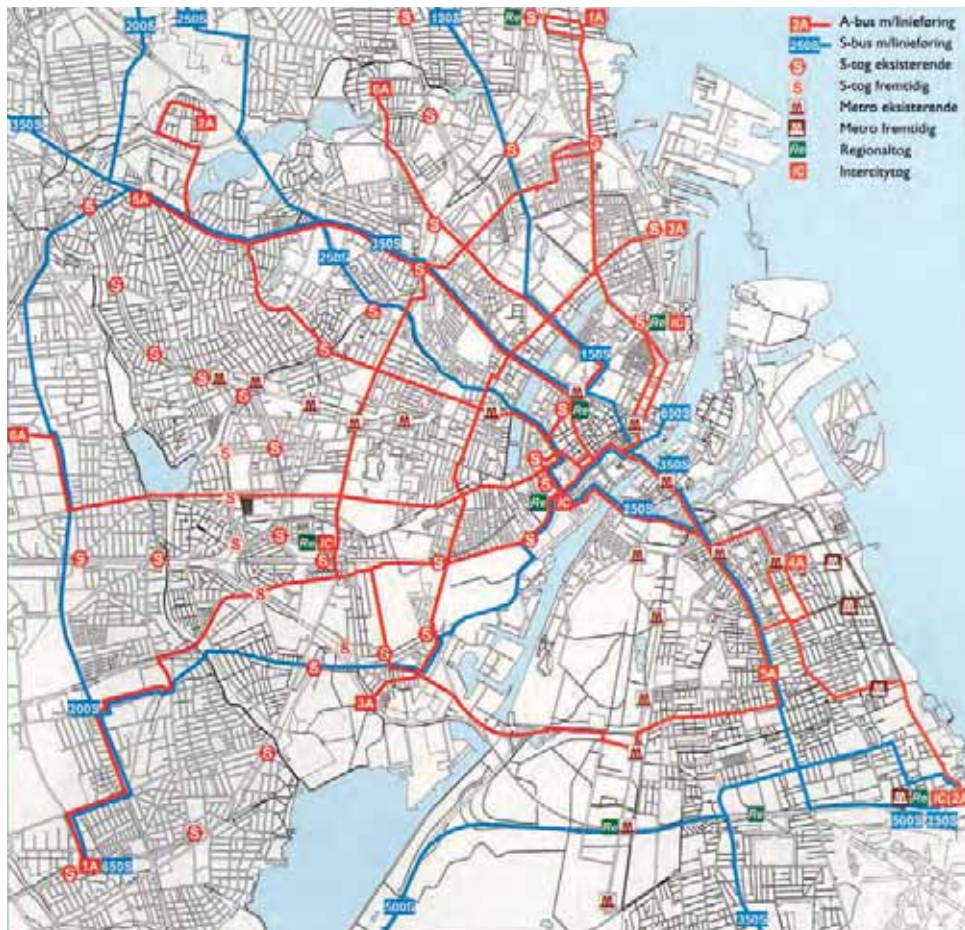

The A-buses (top) are marketed as “the buses with red corners” and the colour is reflected at the stops. Likewise the S-buses’ colour is blue.

PHOTOS: GUSTAV NIELSEN / RENÉ STRANDBYGAARD

Network map with A- and S-buses in central Copenhagen. Source: Traffic Plan of Copenhagen City

The Copenhagen region is working hard to improve the speed, reliability and attractiveness of its extensive bus system. One effort is to improve the operational speed of buses through traffic management measures such as bus-only lanes, bus gates, moving or closing down bus stops, bus priority at traffic signals, bus running straight ahead in right turn lanes and traffic access control by signalling.

Another important measure is to upgrade

the general quality and strengthen the design of the main network.

Six bus lines are defined as A-buses. The A-buses are urban bus lines operated with 3–5 minute intervals at daytime, which means that passengers can travel without consulting timetables. The S-buses are fast, suburban bus services that supplement the suburban S-train network in areas without rail tracks. Together with S-trains, regional trains and the new Met-

ro, the A- and S-buses form the main structure of the city region’s public transport system.

The A- and S-buses are designed and marketed as special high quality services. Through a simple, dedicated design and colour scheme for buses and information signs, the services are easy to find even in busy city traffic.

Source: Hovedstadsregionens udviklingsråd (HUR) 2002e.

Create high quality trunk lines or corridors

In recent years, some cities have upgraded the quality of their public transport system by the development of high quality trunk lines or high quality corridors. The idea is to combine several types of improvements to one or more major bus (or light rail) lines or corridors in the city region. Usually several of the following measures are used in combination:

- ▶ A simple and clear line structure, reducing to a minimum the number of line variants and deviations in routes and timetables.
- ▶ Fast and direct priority routes, with simple timetables and reliable operations.
- ▶ High frequency services over most of the day, week and year.
- ▶ Highly profiled lines through the design of vehicles and stopping places, information and signs and simple network maps.
- ▶ Real time timetable information to the passengers at waiting places and on board vehicles.
- ▶ Ample capacity and passenger comfort in low floor vehicles.
- ▶ Simple ticketing systems that reduce stopping times and passenger hassle to a minimum.
- ▶ High quality design of stopping places and interchanges for efficient service operations, passenger comfort and enrichment of the urban environment.
- ▶ Low levels of noise and air pollution emissions.

The high frequency service is an important aspect of the concepts of trunk lines and quality corridors. For modern light rail systems, the idea of the high quality line or corridor is self-evident. However the same principles are also being introduced in cities that want to upgrade their bus systems significantly, through the creation of high quality bus corridors or separate bus ways. The latter may even include various forms of guided bus systems.

3.5 Finding strategies for the weaker markets

In large European cities, with half a million inhabitants and more, it is easy to find corridors with sufficient demand for the creation of high frequency services. In smaller urban areas, the design of the network structure is more critical for the possibilities of creating high frequency services and corridors. Also for most regional public transport services, there are few opportunities for high frequency services. The regional services cater for fewer, but longer journeys, and discussions about service levels often evolve around 30, 60 or 120-minute headways. The following section discusses the strategy of service integration as a solution for travel markets that cannot support ordinary, high frequency services.

Common trunk line sections in small cities

In small and medium sized cities very often the demand for public transport is insufficient to have many high frequency lines running through the cen-

tral city and out into the suburbs. The solution can then be the creation of a public transport network where several lines follow the same, common route through the central parts of the urban area.

Common trunk line sections make it possible to offer a high frequency service, at least for journeys between destinations along the trunk section. However, these sections should not be designed through the simple collection of different line routes to one or several main corridors through the central parts of the city. In practice this will normally not achieve the required even headways between vehicles running on different lines, and one may easily run into the problems of queues and convoy formations in the corridor.

In some cases, the best solution is to plan the network with only one main line on the common section, and have different branches of the main line in one or both ends of the common section. The alternative is to have two or three lines with strictly coordinated timetables to achieve the same effect of even headways. In practical operations this is very difficult to achieve if the lines are run by different operators.

Timetable coordination

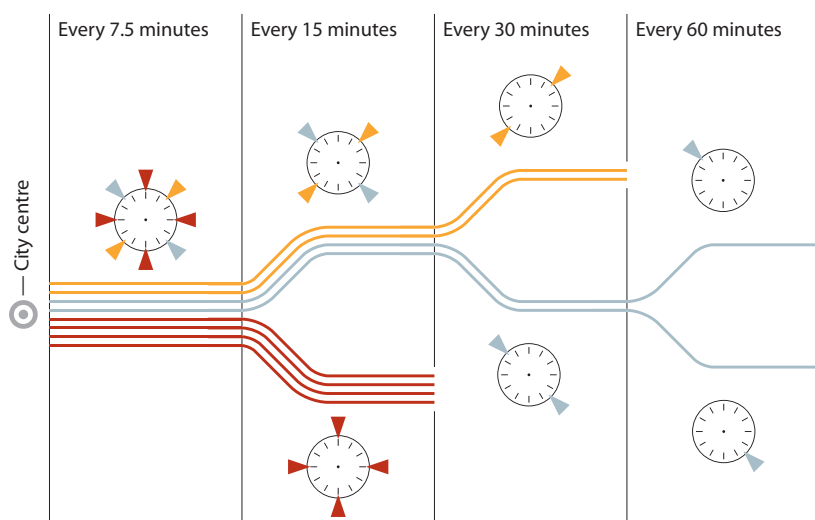

In small cities timetable coordination of the services of several lines is often necessary to achieve the required high frequency levels in quality corridors or on trunk line sections.

Pulse timetables for low frequency services

In small towns, and in the outer suburbs of larger cities, the demand for public transport is too dispersed to run high frequency services. A service with only one or two buses per hour will in many cases be the best that can be achieved, even when there are significant public subsidies available for the services.

Even if a full "forget the timetable" service is not possible, significant improvements over traditional low quality networks can be made through the introduction of pulse timetables. This is a principle of network operation that is being used at the national level for the main line railway system in Switzerland, as well as in several urban regions, mainly in Switzerland and Germany.

The line structure of the network and the departure and running times are coordinated according to a pulse time table. At certain important stations and nodes in the public transport network arrivals and

The principle of pulse timetable operations

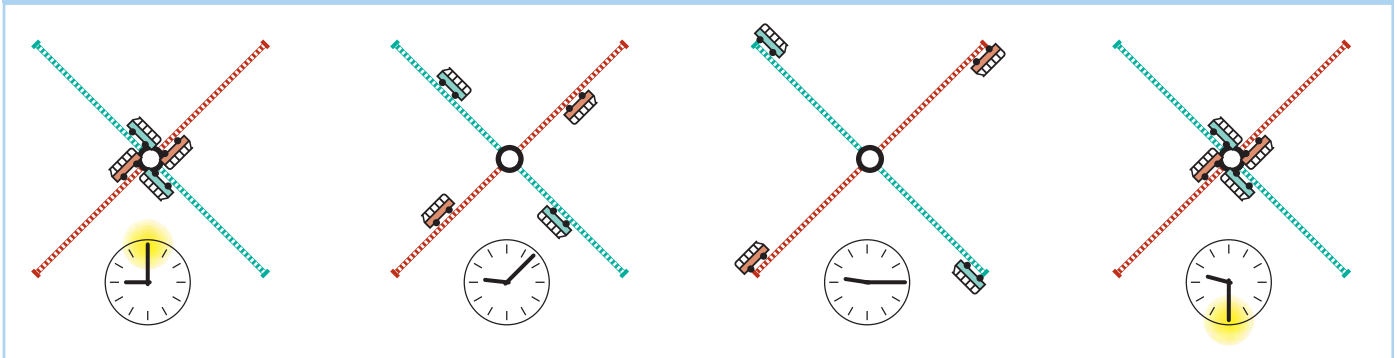

departures of all lines are synchronized in order to facilitate passenger transfers between lines with as little time loss as possible.

A typical example would be the main railway station in a small town, or a suburban centre on a light rail or express bus service. The station is served by a local bus network with all lines going past the station and connecting the different parts of the town or suburban district. For example, every hour, or half hour, all train and bus lines meet at the station. The buses arrive shortly before the train, and leave the station as soon as transfer passengers from the train have reached the right bus. Also transfers between bus lines are made in the same interval.

Often the whole town or suburb can be reached within less than 15 minutes' drive from the station. When the main station is close to the town centre, a simple and efficient local bus service can in this way cater for a large part of the local travel demand, and at the same time provide feeder services to the regional or national public transport system.

An integrated approach to small town quality bus systems

Since the middle of the 1990s a number of small cities and regions in Nordrhein-Westfalen in Germany has managed to significantly improve their local bus systems, both in terms of patronage, quality of service and economics of operation. A report

summarising the experiences from 14 towns with 15,000–80,000 inhabitants (Land Nordrhein-Westfalen 1999) recommends the following principles for the development of small city bus systems:

- ▶ A simple, clearly arranged network with direct, through running pendulum lines.
- ▶ All lines are connected at a single bus stop and meeting point in the city centre.
- ▶ A fixed-minute schedule co-ordinated for all lines consistently during all operating hours, supplemented by a demand-responsive public taxi service in the late evenings.
- ▶ The same high level of service should also be operated at weekends.
- ▶ Short distances between bus stops (we are sceptical to the recommendation of 300 metres indicated in the report).
- ▶ Properly equipped and neatly designed bus stops with well lit, glassed waiting room, information that is easy to read and understand, and bicycle parking facilities.
- ▶ Simple measures to facilitate bus traffic operations in the road traffic system, in order to secure punctual and easily accessible bus services.
- ▶ Modern vehicles, normally climatized, low-floor buses, with a comfortable interior and an attractive and distinct design (communal design) to facilitate the marketing of the system.
- ▶ A simple, customer-friendly fare system.

Some small city bus systems in Nordrhein-Westfalen – key facts

	Population	Year	Urban bus journeys per inhabitant per year		Total cost DM per inhabitant per year*	Fare income as percent of bus operation cost
			Before	After**		
Bad Salzuflen	57,000	1997	5	21	–	–
Bünde	43,000	1998	3	11 (24)	42	34 %
Detmold	80,000	1999	6	50 (61)	100	86 %
Dormagen	62,000	1999	12	29 (30)	146	30 %
Lemgo	42,000	1999	1	46 (65)	69	70 %
Rheine	75,000	1996	26	31 (32)	87	34 %*

* Incl. administration, information, marketing and maintenance of bus stop equipment.

** Figures in brackets () are for the catchment area of the new city buses only.

Source: Land Nordrhein-Westfalen 1999. Estimates of data per inhabitant and cost coverage by us.

- Intensive marketing and an information service office close to the central meeting place of all lines.

These characteristics are independent of the cities' population size and number of bus lines, and they are valid for all levels of demand and the economic result of the operation. The normal sized buses have 34 seats and 67 standing places, but many towns prefer the smaller midi buses with a total length of 7,0–10,3 metres and a width of 2,0–2,5 metres with some 26–70 places in total.

In all towns the new city bus systems are planned in coordination with the regional bus services in order to serve the customers in the most efficient way. The same quality standards should be applied to bus stops, vehicles and the presentation of the city and regional bus services.

Reliable services and interchange design are key elements

The pulse timetable operations can only be successful when running times of trains and buses are stable and reliable. The waiting time for buses at the

interchange is a key factor for the efficiency of the local bus operation. This time element is determined by the time the transferring passengers need to walk between train platforms and the buses. When the crossing lines have a high frequency service, this element is less important since a late transferring passenger will have an acceptable waiting time for the next departure. When the lines have only 1–2 departures per hour, the extra waiting time will be a strong disincentive to the use of the public transport alternative.

If a high quality interchange with short walking distance between the different lines and modes cannot be built, this should affect the choice of line structure for the local buses. Due to the long waiting time for buses at the station, one has to decide which travel demand should have first priority; either the feeder service to and from the regional services, or the local connections between different areas on either side of the station. In both cases, the final solution will be a less cost effective operation, than what can be achieved when all elements of the highest quality solution are in place.

GOOD PRACTICE

Pulse principle in Lemgo



Line and network information at stops.



City terminal without and with buses and transferring passengers.

Lemgo, with some 42,000 inhabitants, is one of the most successful of the modern small city bus systems in Nordrhein-Westfalen.

A corporate image and information design enhances the simplicity and stability of the bus service and facilitates long-term marketing. No commercial advertising disturbs the image of the system. Three pendulum lines run through the town centre, and a fourth line serves an external industrial area. Each pendulum line gives some 8000 inhabitants short walking distances to a 30-minute basic full day service, with double frequency in extended peak periods on workdays. Late in the evenings a demand responsive taxi service replaces the city bus service.

The city centre interchange terminal has a

compact, middle platform layout and a public transport information centre. The bus service is operated with a pulse timetable schedule, so that the buses on all lines meets at the central meeting point every 15 or 30 minutes, depending of the time of the day.

The new bus system was introduced in 1996 because of very little demand for the traditional service, despite a modest renewal of the system in 1992 with four lines at 1-hour intervals. Before- and one-year after-effects of the restructuring of the city bus service:

- ▶ 960,000 new customers and 240,000 old customers travelling more.
- ▶ 80 percent of the passengers on the new system where new public transport customers.

- ▶ The public subsidy per passenger was dramatically reduced from 7,50 DM to 0,45 DM.
- ▶ 70 percent of the bus operation costs are covered by the fares.

A survey among visitors to the inner city revealed that the bus service had a significant affect on shopping trips to the city centre. The bus passengers shopped more often and used more money on city centre shopping than the car users.

Sources: Land Nordrhein-Westfalen 1999 and Marie 2001. PHOTOS: GUSTAV NIELSEN

3.6 Developing an efficient line structure

The structure of lines in the network can significantly affect the efficiency and attractiveness of the public transport system. The following sections highlight some important aspects of the line structure that may help to attract more passengers and fare revenue and/or improve the efficiency of operations.

Find the right length of lines

Long public transport lines are desirable since they reduce the passenger's need for transfers by connecting several service areas. The total loss of vehicle and driver times at the end of lines are reduced, which means that higher levels of productivity per vehicle and man-hour can be achieved. There are also fewer lines to administer and inform the public about.

But long lines are more vulnerable to operational disturbances, so they require more high quality routes with stable running times. The lines should not be so long that there are large differences in the market demand on different sections of the route. The same type of vehicles should be appropriate for the whole length of the line.

For instance, long journeys between the outer suburbs and the inner city may be best served by high quality, suburban type express buses with comfortable seating for all passengers. Both the length of the journey and safety considerations when running on high speed main roads determines the type of bus that should be used for this type of service. On the other hand, such buses are not suitable for local intra-urban services where people get on and off every 400–800 metres, where running speed is seldom above 50 km/h and standing passengers are acceptable, at least in peak hours.

For such reasons, at least in large urban regions, it will normally be sensible to have some long express bus lines connecting suburbs on both sides of the main inner city if bus priority measures are strong enough to operate the service punctually, unless all such connections are covered by a rail system.

But most suburban lines should normally be more local in character in order to avoid the larger

disturbances of operations that often will occur when these lines are coupled with long line sections in the inner city. Thus, the suburban feeder lines are able to operate in a punctual and stable manner around the main interchanges, with the regional, radial lines running into and through the inner city.

Pendulum lines are often favourable

In many existing public transport networks a number of bus or rail lines terminate in the inner city or town centre. In such cases a great deal can be gained by redesigning the network through the creation of "pendulum lines". By these we mean lines that run from one side of the city or local interchange point to the other without any long stay or waiting time in the centre. (Also sometimes known as "through routing".) This creates a number of positive effects for the public transport system, as well as for the city and its land use.

Direct service. First, passengers are offered a direct service between areas at opposite sides of the city centre. This improvement will be very significant for some inner city destinations. So public transport will see a significant increase in the demand in an important part of the city where car traffic reduction is very much asked for, for the reasons of environmental improvement and more efficient road transport.

Better use of capacity. Second, the utilisation of public transport capacity will improve significantly in the most densely congested part of the city. A greater number of passengers will be carried through the inner city with fewer public transport vehicles. This will improve the operating efficiency of the system and reduce traffic congestion.

More efficient land use. Third, the road and urban land space needed for terminals and stopping places will be reduced when lines run through the centre without any long terminal times. The use of inner city bus stops will be more efficient when people are getting on and off the bus at the same time. This will leave more space for other traffic purposes or for more urban development. This takes place in the centre of the city, where land values normally are at their peak.

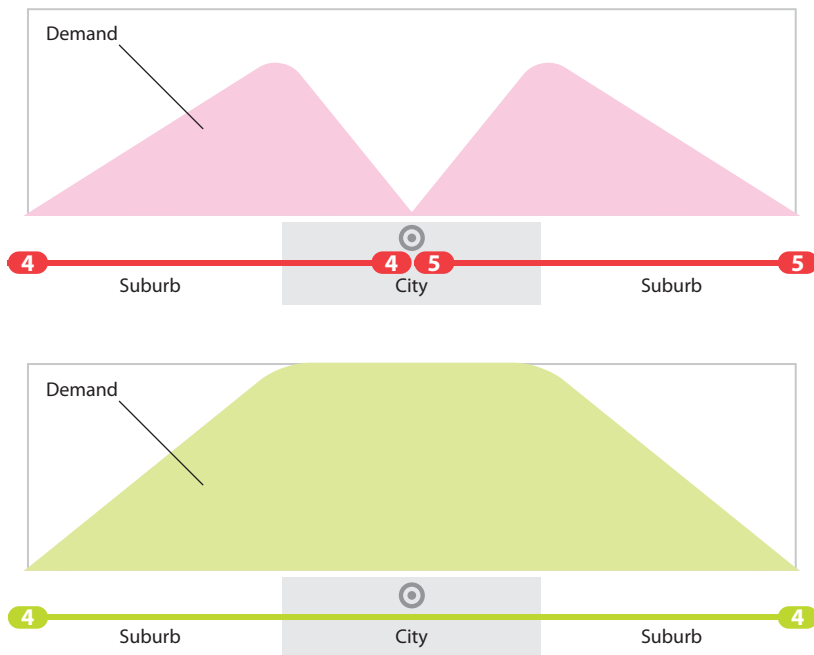

The principle of pendulum lines between opposite suburbs or service areas through the inner city via the city centre.

The same principle can be applied for lines running to or past other local centres and interchanges.

In red: When the lines terminate in the city centre the number of passengers on the line increases from the suburb starting point towards the inner city. But after full capacity has been reached at the edge of the inner city, passengers disembark on the way to the city terminal. On the last part of the tour, in the most heavily congested part of the city streets, the volume of passengers is far below capacity.

In green: When the line runs through the city, passengers continue to board after the inner city has been reached, so that the capacity of the line is far better used on the inner city sections of the line. Thus, a more efficient use of the capacity is achieved, and there is no need for a big terminal area for the buses or rail vehicles in the city centre

Similar effects can be found at other centres and interchanges where terminating lines are replaced by pendulum lines. Equivalent arguments apply to through routing trains.

Taken together, the combined effects of increased patronage, improved operating efficiency and the environment and urban land use benefits, may in some cases become a very significant improvement of the public transport system. When local conditions allow for more use of pendulum lines, the opportunity should not be missed.

Reduce uncoordinated parallel services

In order to increase system efficiency and concentrate demand on few high frequency lines, network planning should in many cases aim at reducing the number of parallel lines and services. Several reasons for this may be applicable, although all must be seen

in the light of the market situation in the urban area in question.

Sometimes one can achieve more by moving given operational resources from a corridor carrying heavy traffic to a different area or section with potential for more traffic. This may be done by taking away the binding connection between the frequency of service and use of operational resources on a suburban section served by one line, and the excessive resources used on a common, multi-line section of a radial corridor into the inner city. When a transport corridor is congested with queues of buses or trams, it may be more efficient to reduce the number of vehicles, if capacity is excessive due to a multi-line service in the corridor.

The classic situation is the suburban corridor where buses run parallel to a rail service with potential for improvements. Then sufficient capacity may be provided through the use of longer trains

or increased frequency on the rail service, and the buses might instead do a better job in the network by providing improved local and feeder services in the suburbs. Although this increases the need for transfers between bus and rail, it might improve the attractiveness of the whole network. Travel distances and speeds of the two modes, as well as the urban structure and local travel market, will help determine which solutions should be chosen in a given city region.

If the city is served by a combination of buses and trams, it may sometimes be useful to run them partly on the same streets, if the same stops can be used and the timetables are coordinated. Then the two modes can offer a joint high frequency service on the common section without operational conflicts.

However, in most cases the separation of the two modes on different routes is preferable. This will concentrate the passenger demand along a route on one mode only, which can be run on a higher frequency. The tram infrastructure can be more intensively used. Separating buses and trams also simplifies technical solutions in the street and at stops, particularly when platform heights are different. On streets and roads with mixed traffic often bus and tram stops will have to be located differently. Then passengers in the corridor will have difficulty in making use of the combined high frequency of buses and trams. Trams can also more easily be incorporated into pedestrian zones when they are separated from buses and cars.

All this turns out as a confirmation of the general advice of the principle of one section – one line. But the principle should not rule out all cases of so-called parallel operations. In many cases double services will be justified when the lines in the same corridor have different stopping patterns, so they serve different sub-markets in the corridor. Also, the term of parallel running loses its meaning when the parallel sections are short.

Integrate different concessions of operation

This section looks at the issue of different public transport operations within a particular area, each

with their own operating rights – or concessions. These concessions form a potential barrier to the provision of a high quality public transport service. Sometimes inefficient parallel services are caused by the rights granted operational concessions and the competition between different operators in the same transport corridor.

Competition between different operators and modes in a corridor create incentives to the operators to run their services efficiently and serve the customers better. But each operator optimizes his/her own services with little regard for the other lines, and often the conditions of a concession regulates the market so that different lines in the same corridor are forced to have separate roles to play in the local transport market.

This can easily lead to the inefficient use of transport capacity in corridors served by different operators under separate concessions. Often city buses and suburban buses run on the same radial roads in the inner city, sometimes creating heavy bus traffic in peak periods. Operational restrictions on the suburban buses force these buses to refuse admittance to many passengers waiting for city buses on the same route, even when the bus stops for disembarking passengers.

In this way full use of the buses cannot be made. This has a deleterious effect on general traffic congestion and the environment in the central parts of the city, as well as on the bus operations themselves. In addition, the segregated line network makes the system more complicated and difficult for the users to understand.

In order to reduce travelling times for long journeys, a different stopping pattern is obviously needed for express services. Good practice requires that such services be integrated with the local services through carefully planned locations of interchanges. With low frequency services, also integrated timetables are desirable. In an open market with on-the-road competition, this level of integration will normally not be achievable. With concessions and tendering this may be assured through appropriate contract requirements.

Improving efficiency by integrating different concessions of operations

Separate concessions

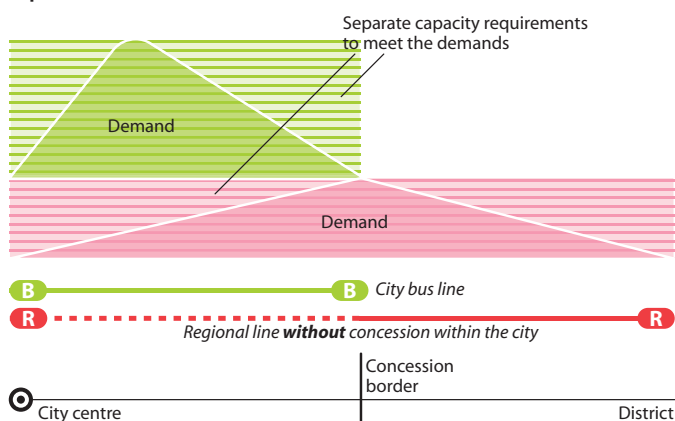

Shared concession

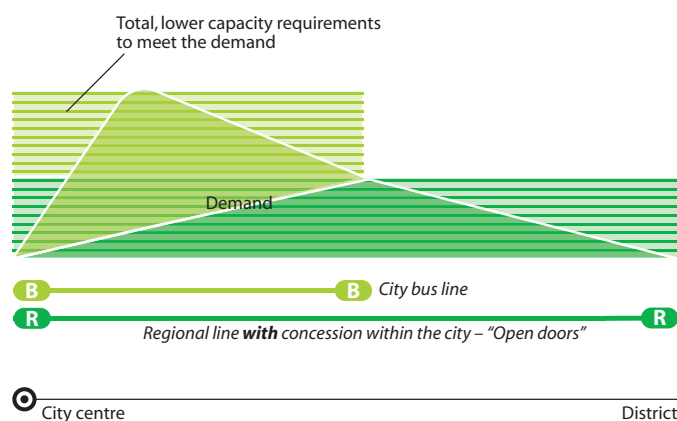

"Open doors" for parallel lines in a corridor may improve system efficiency by allowing passengers to board and disembark services without the barrier of concession limits.

3.7 Travelling as fast as possible

Travel time is a major consideration when people choose to go by public transport or not. The gross speed of the public transport vehicles is also a highly significant factor influencing the cost of operation. Therefore, network planning should seriously consider all possibilities for the speeding up of services. The following sections introduce the different measures that might be studied in greater detail for a particular situation and urban region.

Define the basic, acceptable walking distance

Five minutes of normal walking may be considered a useful measure of an acceptable maximum walking distance to public transport stops in a typical area of a medium sized city. This is the equivalent of a 400 metre circle around the stops.

If the urban area to be served is continuously built up, the whole area would be satisfactorily covered if we have a public transport network with some 800 metres between the lines and some 600 metres between stops. The average walking distance would in this case be approximately 300 metres, corresponding to 3 minutes of normal walking.

However, there is also a complex relationship between the length of the total journey, the walking distance and the distance between stops that affect the speed of the journey on the public transport vehicle. The walking distance, obviously, is more important on short journeys than on longer ones.

We may return to the theoretical, continuously developed 800 metre wide urban development which is served by a public transport line along the middle of the development. For a 4 km long journey in this urban area, the minimum average time for walking and riding will be achieved if the distance between stops is 700 metres. If the journey is 8 km long, the minimum travel time will demand a stopping distance of 900 metres. (Source: PLANK 1981).

But usually passengers experience the time spent walking as a greater burden than the time spent riding in the public transport vehicle. If the walking time is valued as high as three times the in-vehicle time, the optimum distance between stops would

be 500 metres for the 4 km long journey, and 650 metres for the 8 km journey. (Source: PLANK 1981).

When developing the public transport network, it seems sensible to give some priority to the competition between the car and public transport, rather than competing with walking and cycling. Hence, a greater effort should be made to develop public transport as a competitive alternative for long and medium long journeys in the urban region. It is also necessary to make allowance for the fact that operational costs go down when the operational speed increases. Both factors are clear arguments for greater spacing of stopping places than the initial, basic figure of 600 metres.

In the real world, urban development is not homogenous. Open, undeveloped areas are found inside city boundaries, and some areas are densely developed. The road system, topography and other barriers also affect the location and spacing of public transport stopping places. By adjusting locations for a best possible coverage of travel destinations and origins in the city, the average distance between stops is likely to be somewhat longer than the theoretically optimum for the homogenous city. The possibility of developing several different types of public transport services complicates the matter even further.

Nevertheless, as a general advice for network planning, the evidence discussed in this section tells us that traditional full-stopping local bus and light rail systems will have an optimum average distance between stops of 600–800 metres. This is several hundred metre longer than existing urban lines in many cities. Where this is the case, faster travel by public transport can be provided at lower cost of operation if a significant number of stops can be relocated or closed down.

Consider the effect of stopping intervals on travel speed

Other things being equal, the speed of travel is a function of the distance between stops, the maximum speed of operation on the line and the rate of acceleration and deceleration at stops. The latter

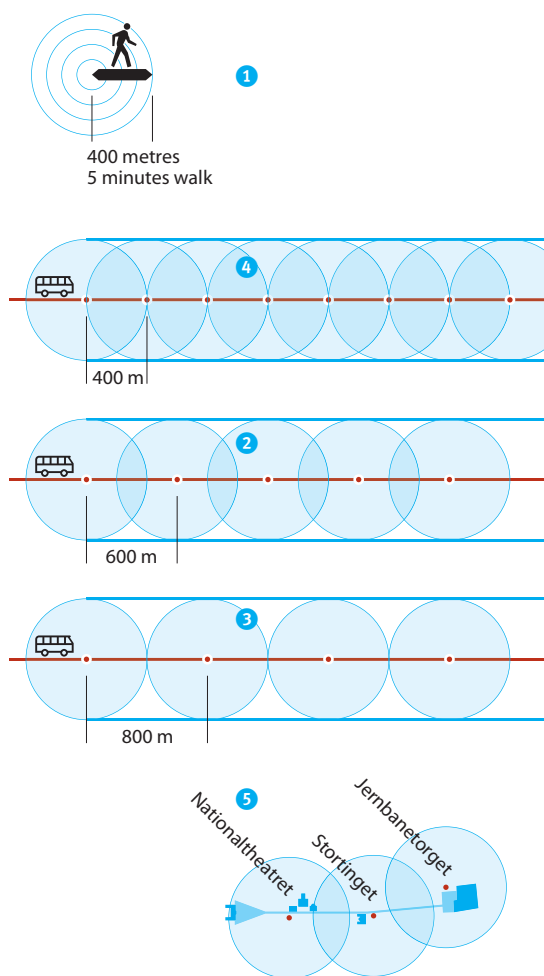

Acceptable walking distance:

A basic parameter for public transport planning

How far are people willing to walk to and from public transport stops and stations?

Surveys in different cities have given varying results. The catchment area depends on the local situation, transport mode and service frequency, in addition to individual resources and physical capabilities.

1 With a normal walking speed of 6 km/h or 100m/minute, it will take 5 minutes to walk 500 metres. We might consider this as the maximum distance we will accept when we are competing with the private car. If we overlook the effects of topography and other barriers, and consider the fact that walking routes seldom are quite straight, we may think of the 5 minute walk as the equivalent of a 400 metre circle from the public transport stopping place. We may use the 400 metre radius circle to describe the catchment area of a public transport line as an 800 metre wide belt, 400 metres on either side of the route.

2 If the line runs through a continuously developed area, a distance of 600 metres between the stops looks sensible.

3 Stops further apart leave significant gaps in the catchment area belt.

4 Stops closer to one another bring needless overlapping within the catchment area belt and will significantly reduce the operational speed of service. In general it seems unlikely that the users are willing to walk longer distances at right angle to the public transport route, than along it.

5 The catchment area of 400 metres radius may be applied to the, for Norwegians, well known three central metro stations along the main street of Karl Johans gate in Oslo. The walking distances here, in a mainly pedestrian street, are probably quite acceptable for most users.

will be decided with particular regard to passenger safety and comfort inside vehicles. With these factors in mind, we have the following general conclusions:

For regional traffic on separate rail tracks a operational speed of some 65–70 km/h is attainable if the average distance between stops is some 2.0–2.5 km. But if the distance between stops is reduced to some 800–1000 metres, the average speed will drop to 40 km/h, with no need for trains or light rail vehicles that travel faster than 100 km/h.

For express buses in regional traffic (as opposed to long distance buses) on urban motorways the practi-

cal maximum speed can be set at 80 km/h. In order to serve some important local centres and interchange points in the corridor towards the inner city, the average operational speed easily drops to 52–58 km/h even if the buses have full priority over cars in the road system. Often such lines also have sections for local collection and distribution of passengers at one or both ends, which may bring the average speed along the whole line down to 50 km/h before any delays from traffic congestion are included.

In urban traffic with a maximum speed of 50 km/h an average distance between stops of 600–1200 me-

The attainable, operational speed

The attainable, operational speed of an urban public transport service will to a large extent be defined by the maximum speed allowed and the distance between stops.

The diagram shows the relationship between attainable operational speed, the distance between the stops and the maximum speed. The average rate of acceleration and deceleration is assumed to be 1.0 m/sec^2 and the average time at each stop is set at 20 seconds, which are fairly conservative conditions. To achieve these operational speeds the public transport service must not be significantly delayed by other traffic, long waiting times at traffic lights, long boarding times due to overcrowded or inefficiently designed vehicles, queues at the stops, inefficient ticketing system, etc.

A few examples indicate the operational speed one might work towards in order to get the most out of different public transport modes:

City bus or tram. Given an optimum distance between stops for full stopping urban services of 600 metres, a bus or tram service on streets with a speed limit of 50 km/h can achieve a operational speed of 28 km/h. If the service is run on main roads or separate right-of-way with a speed limit of 80 km/h, the service can operate the same stopping pattern at a 10 percent higher operational speed, 31 km/h.

In local, residential streets and in shopping streets in the city centre, the maximum speed may be restricted to 30 km/h. Then the operational speed on these sections will drop to 21.5 km/h if the distance between stops is 600 metres. In

city centres, where the passenger traffic is very dense, 400 metres between the stops might be more appropriate. This will only reduce the operational speed on the 30 km/h sections by some 10 percent, to 19.5 km/h.

The 600 meter stopping interval will make maximum speeds above 80 km/h redundant, unless there are significant sections on the lines that have no stops to serve.

For long journeys, the operational speed of 31 km/h will be far too slow to be attractive to other than captive riders. Then the stopping distance will have to be increased. In a continuously developed urban area this creates the need for a differentiation between local full-stopping services and regional express services.

Express bus. As examples of regional services, we assume that on average every third or fourth ordinary local stop will be served with an express bus or rail line. The regional service will then have an average stopping interval of 1800 or 2400 metres (given the assumed optimum distance of 600 metres on local bus or rail services). Then we find the following attainable operational speeds for typical regional or suburban services:

An express bus on an urban motorway might have a maximum speed of 80 km/h, unless the urban motorway has a reduced design speed to fit into the urban structure. With very efficient solutions for bus stops along the motorway, the operational speed on these sections might be 58 km/h with a stop every 2.4 km and 52.5 km/h with 1.8 km between the stops. Long distance express buses do not stop so often, but they are not part of

the urban region's internal network.

Very often, however, suburban express bus lines are operated with collection and distribution sections in one or both ends. As indicated in the diagram, this might bring the average operational speed of such lines down to some 47–50 km/h.

Light rail express. A light rail service on separate right of way, or an express bus on a separate bus way, without restrictions from local, full-stopping services, might be designed for a maximum speed of 100 km/h. The stopping intervals of 1.8 and 2.4 km will then allow an average operational speed of 58 and 64 km/h, respectively. This is more than the double speed of what can be achieved with a full stopping service with 600 metres between stops, and a good compensation for the longer distances to and from the regional stopping places.

Suburban rail. The diagram also illustrates the effect of running the suburban and regional service by a main line railway train with a maximum speed of 120 km/h. This will allow for operational speeds of 60 and 69 km/h with stopping intervals of 1.8 km and 2.4 km, respectively.

Source: Model calculation by Civitas.

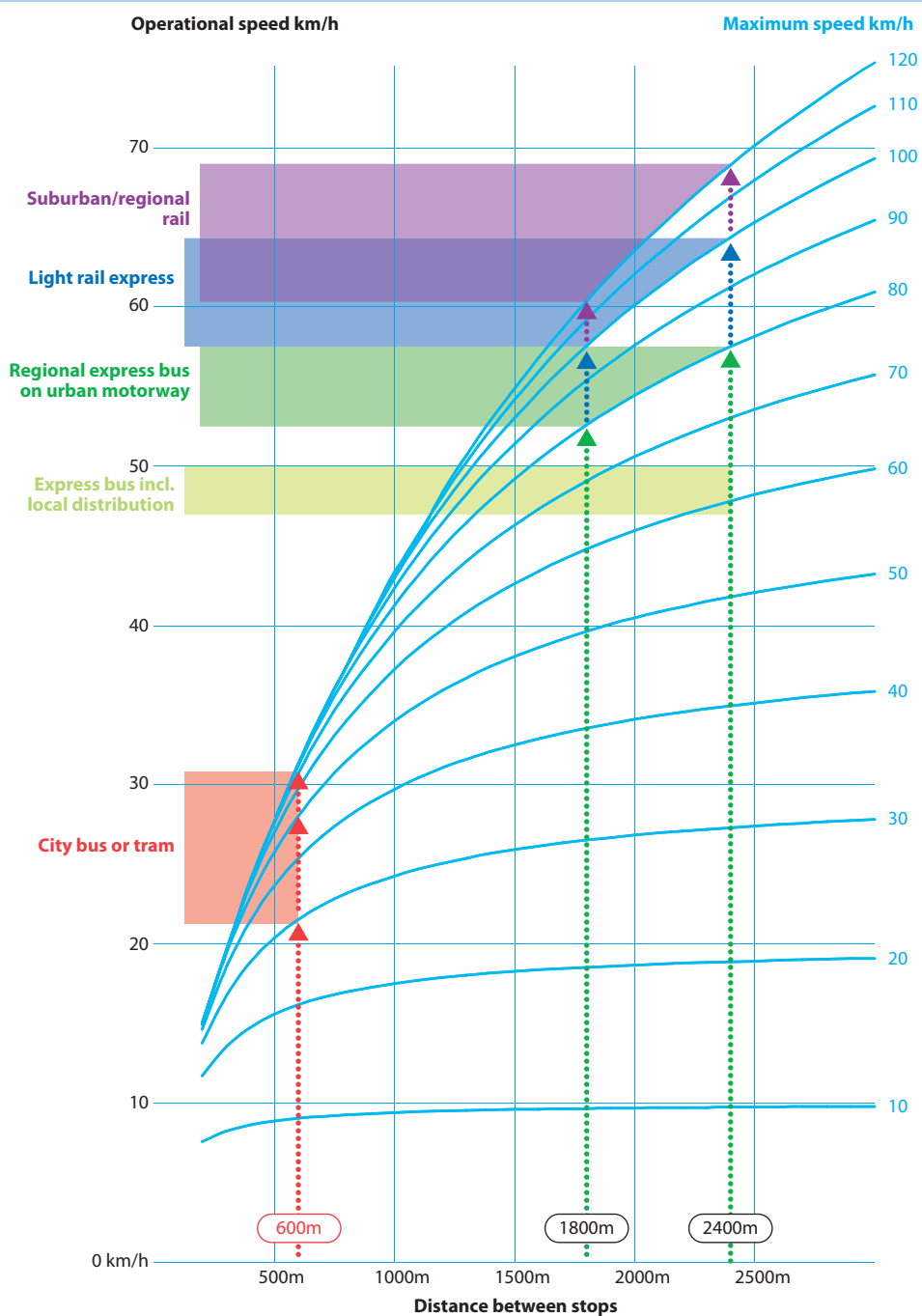

Attainable speed		
	Average distance between stops	Attainable operational speed
Regional, main or light rail service	2.4 km	64–69 km/h
	1.8 km	58–60 km/h
Regional buses, combination of express and local, full stopping service		45–50 km/h
Urban bus, light rail or metro service	1000 m	42 km/h
	600 m	28–31 km/h
On busy city centre streets with 30 km/h speed limit	400 m	19 km/h

Suggested theoretical attainable operational speed levels for the benchmarking of typical urban public transport lines, without delays from congested car traffic, fixed traffic signals etc. Average figures for lines of 5–50 km.

Quick estimate of potential improvement

The local trains have a operational speed of 45–50 km/h, the metro is operated at 25–35 km/h, the trams and the most heavily used city bus lines are running at average speeds between 12 and 23 km/h. These figures suggest that the public transport system in Oslo offers services that are 40–100 % slower than the estimated attainable speeds of travel.

tres will result in a operational speed of some 36–31 km/h if there are no delays due to traffic congestion or other causes. Stopping distances of 550 meters or below mean that the average operational speed can never be above 30 km/h, even if all other sources of speed reductions are removed.

In central city shopping streets in particular, both a maximum speed of 30 km/h and shorter intervals between stops may be applicable. On these parts of the line the attainable operational speed may be reduced to 19–20 km/h even before significant delays due to traffic lights, passenger congestion, etc.

From these facts, we might set up a set of indicators for benchmarking the operational speeds of typical urban public transport services.

In practical operations we will normally find that cities and public transport operators have difficulties in reaching the average speed levels mentioned here.

It is important that the public transport planner analyses the reasons for the gap between the theoretically attainable and actual operational speeds of different lines and modes, locate the problems

and start working on those speed improvement measures that can be realised in the local operating environment.

Try to improve all factors that determine travel speed

The operational travel speed of the vehicle is a key factor in all public transport operations. The speed of travel affects the system's attractiveness, demand and income from the fares. But it also affects the turnover of vehicles and drivers, the number of vehicles needed to provide a given frequency, and the costs of operations. Therefore, every possible effort should be made to speed up the operations. In principle, only the need to stop for the picking up and setting down of passengers should be allowed to slow down the speed of travel.

The task of speeding up public transport operations must be shared by several parties, and the divided responsibilities often form a major obstacle to successful high quality public transport. The following is a list of the different measures that should be explored:

- 1 **Priority treatment** of buses and trams may often be achieved through the use of traffic management measures. This may sometimes require the building of new, separate lanes for public transport. But this is often an expensive and difficult solution involving the expropriation of property and the tearing down of houses. Priority for public transport may also be achieved by changes in the use of existing road space. This will normally cost much less, but requires detailed and often controversial planning processes and changes in car traffic and solutions for pedestrians and bicycle traffic. This alternative will also make the bus or tram more competitive with the motor car.
- 2 **Priority systems** at traffic signals may improve the journey speed of public transport, sometimes also giving the bus or tram a small advantage over the car. But often the new control system will also give more green time for crossing traffic. The signals give priority when a bus or tram comes to the junction, but the total green time needed for public transport will often be less than with the old, fixed interval controls.
- 3 **The control of priority lanes and signals** is important for the efficiency of these measures. Illegal driving and parking by other vehicles is a real problem in many cities. Where this control is left to the ordinary police, they often have more important tasks to deal with. Local traffic police or parking wardens will normally be more efficient, especially if the government allows the fines to be set at a level that more than covers the costs of surveillance.
- 4 **Ticketing systems** affect the time needed for boarding passengers at stops. This time can be reduced by going over from traditional tickets sold and controlled by the driver to pre-paid tickets only, and/or electronic systems of payment.
- 5 **The location and distance between stops** affects average travel speed, and so the total travel time. In many cities the stops are more densely spaced than necessary for optimum travel time. A detailed survey of the location of stops in many cities relieve a potential for significant



Bus gate in Frauenfeld. PHOTO: GUSTAV NIELSEN



Priority traffic signal in Jönköping.

PHOTO: GUSTAV NIELSEN



Low floor vehicles with 4 wide doors reduces stop time in Jönköping.

PHOTO: GUSTAV NIELSEN



The right platform level for the vehicles in use in Kassel. PHOTO: AXEL KÜHN

GOOD PRACTICE

Straight bus stops



The bus can drive straight forward to the stop. There is no loss of time for turning out of and into the car traffic, and the journey is safer and more comfortable for the passengers. Sometimes cars must wait behind the bus at the stop, which gives public transport a small, real and psychological time advantage.



The wide platform gives room for many waiting passengers without disturbances from cyclists.

In cities where high quality bus solutions are promoted, straight bus stops is becoming the standard solution in city streets. Important benefits of this design of bus stops are:

- ▶ Improved comfort for passengers on the bus and at the stop
- ▶ Improved service for passengers by more space for weather protection and information
- ▶ Less conflict between pedestrians and waiting passengers
- ▶ Increased speed and less disturbance to bus operations

- ▶ Fewer conflicts between buses and cars
- ▶ Clarifies conflicts between passing cyclists and bus passengers
- ▶ More road space for car parking before and after the bus stop
- ▶ Easier for the bus driver to take the bus in and out of the stop.

Source, incl. photos: Hovedstadsregionens udviklingsråd (HUR) 2002e.

improvements. Often stop locations have been decided many years ago, when freely flowing car traffic had higher priority in traffic management. For the public transport users often significant improvements can be made by moving stops closer to street junctions with crossing bus or tram lines. Also new development and changes in building uses may affect the optimum location of stops. The pattern and quality of pedestrian routes and other access services may also allow for an increase in the spacing of stopping places.

- 6 **The differentiation** of local and regional public transport services will also speed up travel time for the longer journeys. Both regional rail services and express bus services will do this job. The right balance between local, full stopping services and regional express services will depend on the urban structure and travel market.
- 7 **The design of vehicles** affects the time needed at stops. Low floor, wide doors (several if possible) and suitable interior layout of vehicles can contribute to efficiency and comfort as well as accessibility for disabled and elderly persons, people with prams etc.
- 8 **Platforms fit for the type of vehicles** in use at stops, fixed places for entering and disembarking passengers and clear and concise information also contribute to short stopping times. Straight stops without the sideways movements and possible delays due to passing car traffic of conventional designs should be preferred everywhere this can be accepted on the grounds of traffic safety.

Appropriate interplay between local and regional lines

As discussed above, the optimum stopping pattern depends on the length of the total journey from origin to destination. Long journeys on public transport vehicles would be very slow if all lines stopped at all places along the route. Therefore the public transport network is made up of a combination of local city lines and suburban and regional lines.

But in urban regions, the number of long journeys is normally much smaller than the number of



In the German town of Gera the regional train service and the local tram system meet at the same platform.

PHOTOS: AXEL KÜHN

GOOD PRACTICE

Cambridge core traffic scheme



Cambridge automatic bollards.

PHOTOS: GUSTAV NIELSEN

When a new traffic and environment improvement scheme was implemented in the historical centre of Cambridge, UK, improving the bus service was given high priority.

The Council of European Municipalities and Regions (CEMR) gave the city the European Public Transport Award 2002/2003, and described the traffic solution in the centre of Cambridge in the following way: The scheme is "an excellent example of an innovative and radical initiative which has transformed mobility in a previously congested, historic city centre.

A radical change was needed to control access to the city centre. To work, the scheme would need the support of the majority of Cambridge citizens and many others using the city. A mix of excellence in consulting and involving people, as well as marketing and promotion, partnership working, openness and accountability were fundamental to achieving this.

The Core Area closure and a raft of bus improvement measures has had a huge impact on the use of public transport in the city with a record of 27,000 people per day now travelling in and out of Cambridge by bus.

In 2001, Cambridgeshire County Council agreed a

challenging target with Government to increase bus passenger numbers into and out of Cambridge by 20 per cent over four years. The rise has in fact been more than 30 percent in just three years.

Cambridge Park and Ride is now considered one of the most successful in the country with over 1 million passengers and rising using the five sites every year.

The scheme demonstrate that "stick" methods like the Core Area closure scheme when combined with the "carrot" of providing good quality public transport alternatives and good communications has been highly effective in encouraging more people out of their cars.

The Cambridge Core Traffic Scheme proved a brave and visionary approach to tackling congestion. The scheme is now fully integrated into city life – it has the acceptance of the majority of citizens because it functions well and has improved the city centre environment. "

The use of automatic bollards makes it possible to close the city core to unwanted car traffic while giving buses, pedestrians, bicyclists and authorized vehicles unrestricted access to the centre.

Source:

Council of European Municipalities and Regions 2003.

short, local journeys. The full-stopping city services run by city buses, trams, light rail and metro therefore usually operate at higher frequencies (double, for instance) than the regional services catering for the longer journeys between the city and its suburban region. For short journeys the higher frequencies and the shorter distances to the local stops on the city lines compensate for the slower running speed.

The choice between a high frequency local service and a faster, but lower frequency regional and suburban service will depend on the local situation. A comparison of total journey times for the theoretically attainable operational speeds estimated above indicates that a local high frequency service that operates at some 30 km/h will be preferred for journeys of a distance up to 10–15 km in the central parts of the urban region.

Passengers travelling between places and stations that are served directly by fast trains, light rail or express buses, will normally take the first departure (stopping or express) for short journeys, but are likely to wait for the first express departure if the travelling distance is long, generally 10 km or more.

Apart from when demand is so strong that both local and regional services can be operated with high frequencies, it is important to coordinate the timetables for local and regional lines in the same corridor, so that local lines can serve as feeders and distributors for the regional services.

Route alignment can make the difference between failure and success

In addition to the operational speed, the route alignment is of crucial importance for successful public transport operations. It affects strongly the attractiveness of the service, public transport demand, and income from fares, as well as the costs of operation. Within a single urban district the costs and running times can vary by a factor of up to 400–500 percent for different land use layouts and road systems.

In practice, this will make the difference between local success and complete failure to serve the area by public transport. The importance of this aspect of

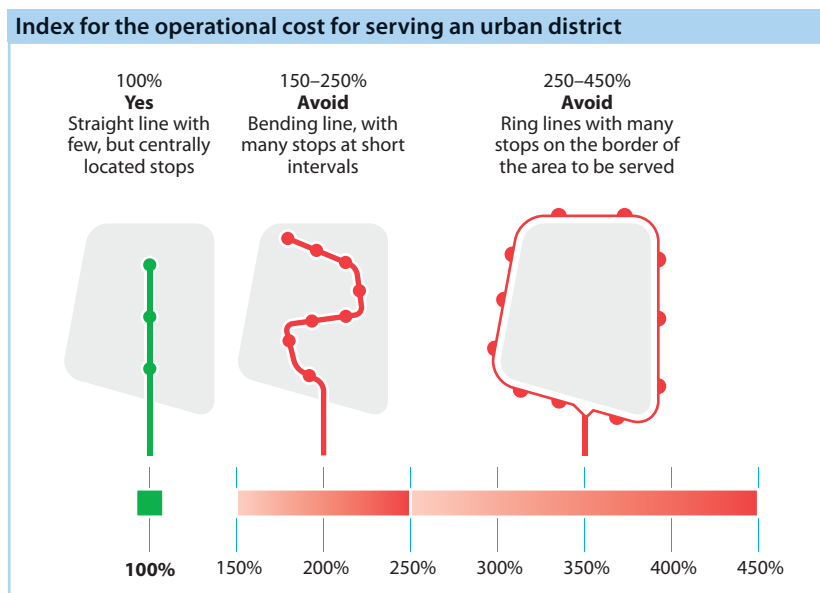

Rational and direct routes are important for the economics of public transport operations as well as for the attractiveness of the system.

(Adapted from Kommunikationsdepartementet 1975.)

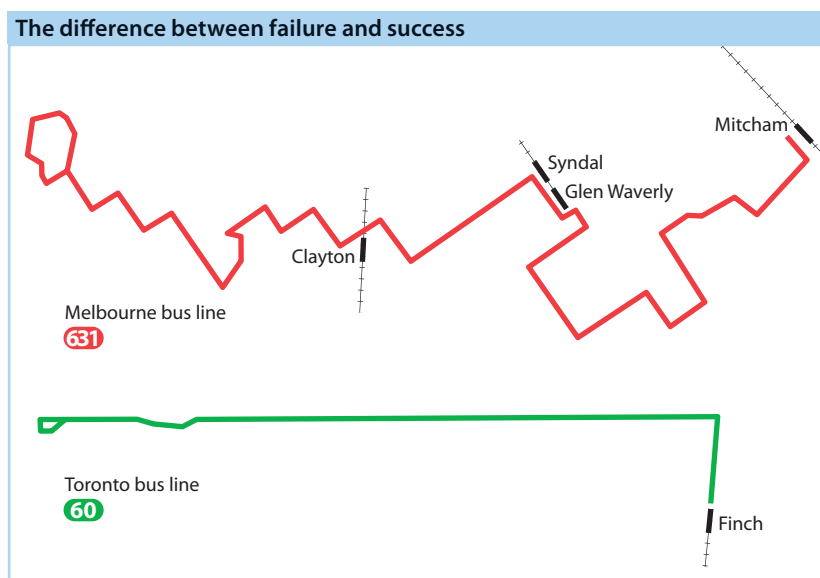

Route alignment – the difference between failure and success is demonstrated by the comparison of bus line 631 in Melbourne with line 60 in Toronto.

(Adapted from Mees 2000.)

GOOD PRACTICE

Priority at roundabouts



Roundabouts are built in order to improve general traffic flow and safety. For public transport they often have a negative impact by reducing travel speed and comfort for bus passengers and drivers. A public transport priority solution for roundabouts would have special traffic signals for tram or bus running directly through the middle of the roundabout. Example from Nordhausen, Germany. PHOTO: GUSTAV NIELSEN

urban and transport planning is not always understood, and this is probably an important explanation for the decline in public transport market share in the last decades.

The public transport lines should, as far as possible, follow the natural directions of travel in the area they are serving. This will give most of the passengers a direct and attractive route to their destinations for both short and long journeys, many without any need for transfers. This will also make the lines easy to understand and remember, and information and marketing is simple. If for some reason the main direction of the line must be changed, it is best to do that at points where many people get on and off, such as an interchange or in the city centre.

At the more detailed, district level the route alignment should be carefully designed. The alignment of the route through residential and industrial districts, through road junctions and roundabouts, local centres, interchange points and stopping places and on and off major roads and local streets – all are decisive in determining the costs of serving an urban district.

In districts where the land use plan and road system has been designed without taking proper care of the requirements of the public transport system, the planner should look for possible improvements in route alignment and efficiency, such as short busways, bus ramps, bridges or new underpasses. Many such infrastructure projects can be very profitable if they allow significant improvements in service level and/or reduced operating costs.

GOOD PRACTICE

Directly through institutional area



A short bus-only road creates a far more efficient bus service in some hospital and university areas in Lund, Sweden.

PHOTO: GUSTAV NIELSEN

GOOD PRACTICE

Directly through housing estate



A short bus-only road that connects cul-de-sac roads created for reasons of traffic safety will often significantly improve public transport accessibility and reduce operational cost. Example from a housing estate in Stavanger, Norway.

PHOTO: GUSTAV NIELSEN

A seemingly insignificant peculiarity on the Oslo bus map ...

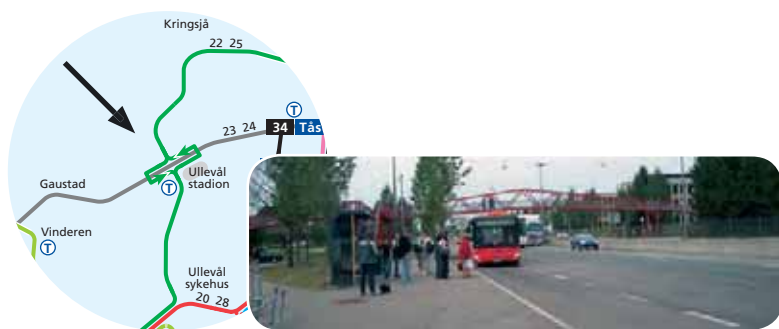

55,000 km added driving distance per year, or 1.4 times around the Earth at the equator. This equals 2,200 hours of added driving time (at 25 km/h)

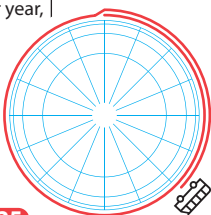

How it should have been ...

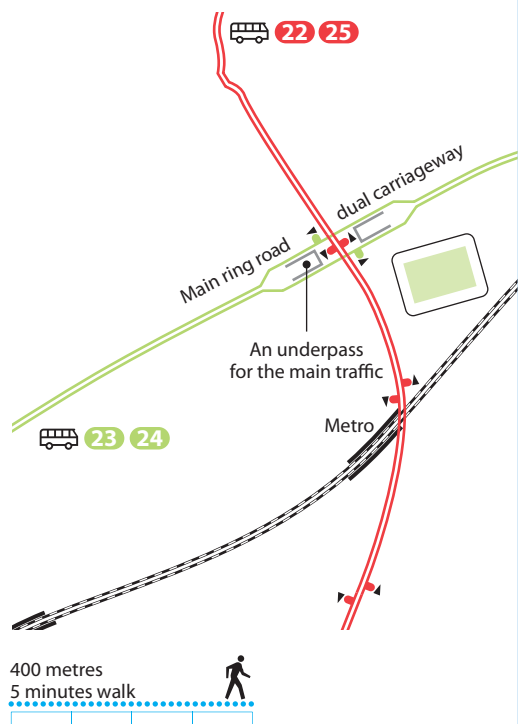
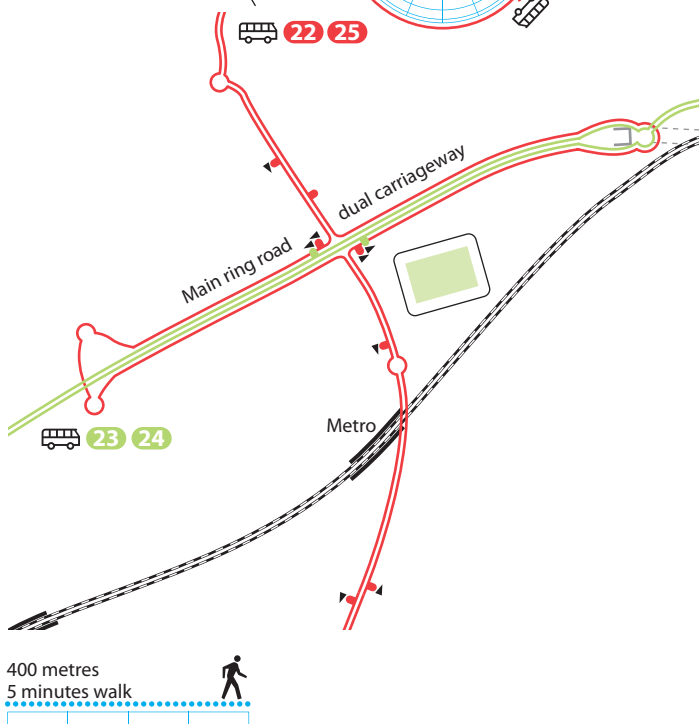

4 Methods and tools for assessment of solutions

4.1 Understanding the need for analytical tools _137

- Why use analytical methods at all? _137
- Choosing the right type of model _137
- Using the right data _138
- Choosing the appropriate method _138
- The 'do nothing' alternative _139
- Very simple methods _140
- National appraisal frameworks _140
- Appraisal as part of policy development _144

4.2 Planning public transport and urban structure _146

- Models fit for purpose in medium sized cities _146
- Finding the gaps in public transport provision _146
- Corridor analysis _149
- Location of major interchanges _149

4.3 Planning for the long term _150

- Tools for the long term analysis _150
- Network planning models _150
- Example of a network problem _151
- Advantages of network models _152
- How much detail is needed in medium-sized cities? _152
- Modelling choice of transport mode _153
- Elasticity models _154
- Learning from impact studies _154
- Cost-effectiveness analysis _155
- Cost-benefit analysis _155
- Dealing with intangibles _157
- Multi-criteria analysis and appraisal summary _157

4.4 Planning in the short term _159

- Different types of analysis _159
- Consumer service investigation _159
- Causal models _159
- Operational planning _161

High quality public transport can only be achieved through good decisions based on analytical assessments of solutions founded on sound theory and precise knowledge of the real world. This chapter provides a simple overview of methods and analytical tools that are available for the assessment of proposals for changes in the public transport operations and network. After the overview section, the usefulness of these methods is described for three different stages of the public transport planning process: as part of structural urban land use and transport planning, in strategic long term public transport planning, and in operational short term public transport planning.

4.1 Understanding the need for analytical tools

By tradition, public transport operations have been a practical, non-academic business. The use of scientifically based analyses and systematic modelling and appraisal has been limited. In this section we discuss some of the benefits that might be gained from a more analytical approach to public transport system and network development.

Why use analytical methods at all?

Sometimes, public transport solutions emerge from decisions taken after exhaustive investigations and based on advanced analytical methods. In other cases, the solutions might be found and decisions taken without any formal analysis being used at all.

Before an overview of methods is presented, one might ask the questions; why use any method at all? Why not rely on (more or less) qualified guesses, or “pure political instinct”? What is the crucial contribution that analytical methodology can make towards reaching good decisions?

The obvious answer is that a decision maker or an investigator wishes to reduce the risk of incorrect decision. One could argue that transportation analysis tools are used in order to avoid erroneous or misleading solutions. Transportation decisions are sometimes a matter of very long-lasting infrastructure investments, with an economic lifetime of 40–60 years, and sometimes of 100 years, as in the case of railways and other rights-of way. In other cases the decisions are about annual operating costs of hundreds of thousands of euros per year for a city or a region. In all these cases, it is an efficient and cost-saving strategy to investigate the probable outcome of various transport alternatives before they are put into operation. Building the wrong metro line or LRT line could very costly, as the decision is highly irreversible.

The alternative to evaluation in advance is “trial and error”, which could mean “expensive and erroneous”. If we accept the need for a better foundation than pure intuition for expensive investment and/or operating decisions, which methods should then be recommended?

It is appropriate to point out to the reader that this chapter is not a manual of methods and tools. Nor is the chapter a substitute for national guidance or requirements for the assessment of public transport projects through cost-benefit analysis or other formal frameworks. The intention is to provide an overview of how the different methods fit together and what they aspire to do.

Choosing the right type of model

All methods imply the use of some sort of model to assist the analysis of consequences and alternative solutions. Models are always a simplification of reality. The only “true model” is reality itself. The art of building and using transport demand and supply models is to choose how to simplify human behaviour in a rational way. And this depends on the type of decision that is at stake.

To make a wise choice about the right type of model to use, two types of errors should be considered: specification error and measurement error.

As an example, assume that the transport problem is fairly complex. For instance, we want to predict how travellers will react to various public transport supply measures, such as a new light rail line. The travellers might consider the following factors:

- ▶ Car competition (car availability, petrol price)
- ▶ Light rail travel time versus bus travel time; and reliability of travel time
- ▶ Light rail headway versus bus headway (frequency of service)
- ▶ Cost of travel by light rail and other modes of transport
- ▶ Comfort and convenience on light rail versus bus
- ▶ Information about the new light rail line.

If the model only takes into account in-vehicle travel time and cost one might make a totally wrong prediction about the appropriate modal choice between car and public transport with the proposed new LRT line. This is called a specification error. The more factors that are taken into account in the model, the more realistic the model will be and the more likely it

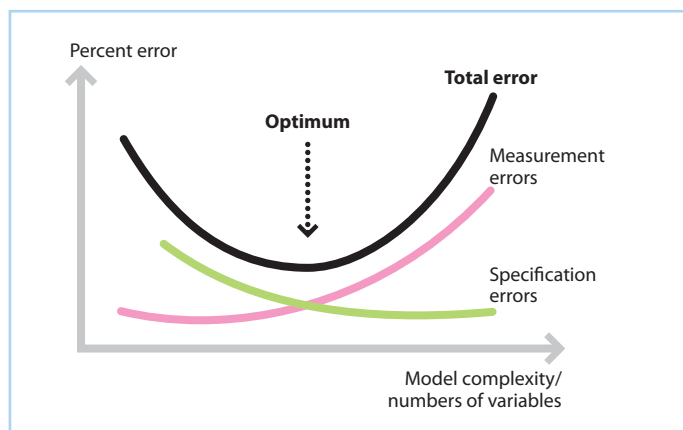

Model errors and optimal level of complexity. The diagram shows error as a function of model complexity, i.e. the number of variables in the model.

is to reflect the true behaviour of the travellers. Thus, specification errors will diminish.

The accuracy of data is a different type of problem. Including inaccurate data does not improve the model at all. As an example one might refer to simple on-street automatic traffic counting machines which usually have a reported 10% error. If a model contains say, 30 variables, and they all have a 10% measurement error, then of course the total error could at worst sum up to a really bad result.

Measurement errors increase as more and more variables (factors) are inserted into the model, whilst at the same time the specification errors go down. The total error is determined by the combined effect of the two errors. There is therefore a trade-off between the level of measurement and specification errors.

Using the right data

It is interesting to note that there exists an optimal level of complexity. This optimal level is dependent on the quality of data. With better and more reliable data, it will become more meaningful to further develop good models. But the collection of better and more reliable data will demand resources and there

is sometimes a trade-off between collecting better data and spending the same money on providing better transport services. It is important to ensure that there is enough data to do the level of planning that is required.

But there also exists another type of relationship that is very often neglected: without formal and quantitative models, nobody asks for good data. With transportation models being introduced and used, the data requirements become more obvious. Good models demand better data, and better data is requested to build models. However there can be the problem that when better data is requested, the emphasis shifts to collecting good data without questioning what it will be used for. It is very important that data good enough for the model being used is collected and that the model being used is appropriate for the task in hand.

Sometimes it is important to work with the data that is available, even if this a preliminary analysis since this will identify if new data is needed and if so, how it will be best collected.

One can argue that using models starts a positive spiral of better decision-making information. And "trial and error", which is equivalent to "expensive and erroneous", is not affordable today. Using good planning methods and tools is in fact an efficient means of reducing uncertainty.

Choosing the appropriate method

Good knowledge and understanding of the different types of methods and tools is a prerequisite for good practice in public transport planning. A primary task is to find the right level of detail and the appropriate methods to assist the analyses. Ease of use and simplicity must be weighed against the need for realistic representation of the real world.

Even more important, the methods used must be appropriate for the problems to be solved. Methods and tools should follow the specification of the questions. A pre-conceived choice of method (e.g. due to the availability of an existing road traffic model developed for other purposes than public transport

Example of the use of time series analysis

In a recent study of factors affecting public transport ridership in the Stockholm region in the period 1997–2001, the main results were presented as in this diagram. It describes the statistical effects of different factors that have affected the observed changes in traffic in this period, expressed as percentage change in ridership. The observed growth in traffic was 4.6 percent, while the model estimate was somewhat less, 3.9 percent.

These results indicated the following conclusions of importance for public transport planning in the Stockholm region at that time:

- 1 The quality of short-term operations should be seen as equally important as medium or long-term investment planning, which is generally regarded as much more interesting. According to the analysis, operational problems in the metro and bus systems influences ridership negatively by as much as –3.4 percent.
- 2 New lines and equipment influence ridership positively. The new tangential light rail

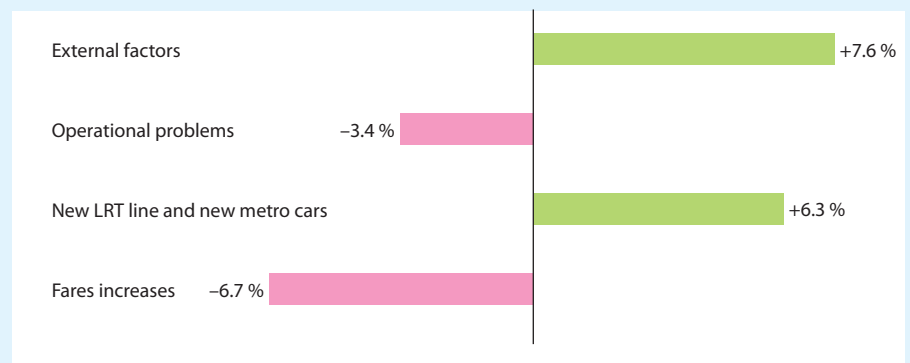

line is estimated to have increased the number of trips in the region by 3 percent. The same growth in ridership is due to the new metro cars introduced around the year 2000, adding up to the 6.3 percent growth shown in the diagram.

- 3 Increases in fares have more than offset the total effect of the new light rail and metro investments, reducing traffic by 6.7 percent in the period studied.

- 4 Factors outside the public transport system's control influence ridership have significant effects on public transport ridership. This example demonstrates how useful this type of analysis can be for public transport policy and planning, and the need for detailed insight into the workings of the market for public transport ridership.

Source: Transek 2002

planning) should not determine the topics and questions to be analysed.

The planner must refer to other sources for more detailed insight into the various methodological approaches and analytical techniques, as well as their analytical and practical advantages, disadvantages and possible pitfalls. In this chapter there is only room for a brief overview and a few examples of good practice in public transport planning.

By "simple" methods we mean methods that are simple to use, but not especially tailor-made to suit a specific transport problem in a specific area at a specific time. What one gains in simplicity, one loses in accuracy. More advanced methods need more human skill, more good quality data sources and more

local experience to be used properly. The benefits of such more elaborate methods are, on the other hand, a more reliable and accurate result. The trade-off between simplicity and accuracy will be demonstrated in the coming sections. But it is necessary to reiterate that more advanced methods should not be attempted if there is not appropriate data.

The 'do nothing' alternative

A general problem is the base that is used for comparison – the 'do nothing' case. This needs to be correctly specified or else the analysis is bound to be erroneous. For example, if a new light rail system is compared with a guided bus system the answer will be different that if it is compared with the existing

system with no investment. The most frequent mistake is analysis on the basis that the current system will continue without any need for investment – to keep it as it is – and this is not necessarily true.

Very simple methods

Even informal methods such as simple rules-of-thumb should be considered as a “method” or decision rule. Examples of such decision rules could be:

- ▶ Choose the cheapest procurement tender
- ▶ Always run buses at a 20 min headway
- ▶ Operating hours should be 06–22

The advantages of such rules are that they are simple to adopt. However, the disadvantages are that they are rather producer- than customer-oriented, often unreliable in practice, and they cannot accommodate new circumstances.

Standard norms are a bit further developed as a method. They are often, but not always, based on studies and investigations about user behaviour or at least on traffic volumes, travel times and other empirical observations. Typical examples of standard norms are:

- ▶ Acceptable walking distance to bus stops and to rail stations for various types of settlements (single family house, multi-storey houses, offices etc.)
- ▶ Frequency of bus service in rural areas
- ▶ Norms for standing passengers in rail, metro and bus, according to trip length in time and in terms of percentages acceptable share of standing passengers.

The advantage is that once these methods have been formulated, the standard norms are simple to adopt. However, they can be rather difficult to formulate in a suitable way, so as to suit a majority of potential public transport users.

The disadvantage of such standard norms is that they are difficult to postulate in an objective way. More often the planner has to make the decision in a more subjective way. Another major drawback is that larger improvements than required to fulfil the norm do not get any score at all. By definition of the norm, goal achievement is either 0 or 100 percent.

National appraisal frameworks

The methods used for the analysis of different measures and policy directions in the development of the public transport system can be very complex, or rather simple, depending on the type of problem and action under study, and on the resources and data available for the analysis.

For transport projects that demand Central Government support or approval, the choice of appraisal methodology must comply with national requirements. In most countries this means that some form of cost-benefit assessment will be required. The purpose of such appraisal is to assess the social profitability of the project and to identify critical factors in the calculated cost-benefit factor. Another important aspect of good practice is to provide a systematic and transparent list of the project’s costs and benefits, thus supporting an open, democratic decision making process.

A Danish review of appraisal methods in eight countries (Denmark, Finland, France, Germany, Netherlands, Norway, Sweden and United Kingdom; Trafikministeriet 2002) identified three different classes of evaluation frameworks in use:

- ▶ **Multi-dimensional comparison**, where the different effects are described separately in money terms, by other quantitative factors, or in qualitative terms according to well defined, systematic principles.
- ▶ **Multi-criteria analysis**, where some form of weights is used to summarize all the different effects into an evaluation criterion for the ranking of alternative projects or actions.
- ▶ **Cost-benefit analysis**, where all effects are valued in money terms and added together to provide a total value of the projects.

In all the countries a form of cost-benefit analysis is used, which in most cases includes the costs of infrastructure, maintenance and operations, travel time, accidents, traffic noise, air pollution and greenhouse gases. Some countries also include effects such as the cost of tax financing, traffic disturbances in the construction period, vibration in buildings, severance or barrier effects, soil and water pollution,

4.1 Understanding the need for analytical tools

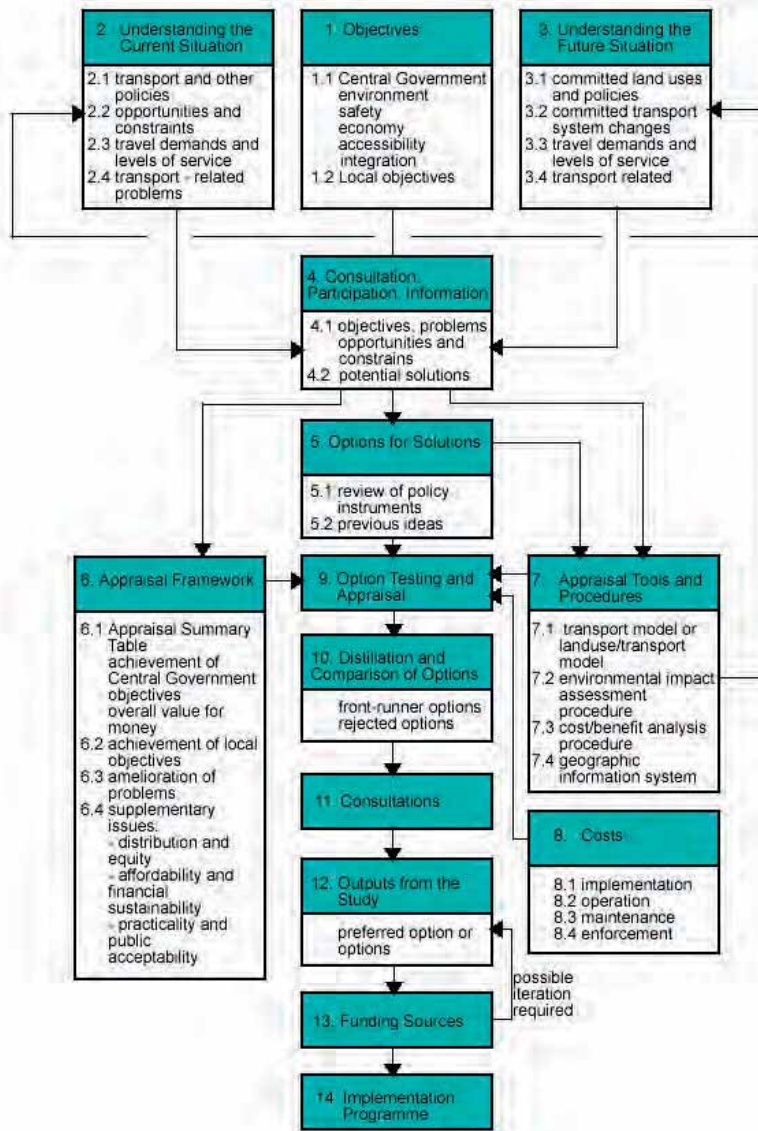

Recommended study approach for the appraisal of transport policies and projects. (Facsimile – Department for Transport (UK) 2004).

A Appraisal Summary Table for the New Transport Initiative

The Appraisal process of the Integrated Transport Initiative for Edinburgh and South-East Scotland is an example of the UK procedures for the development of complex urban transport policies including public transport development and congestion charging. The city's application for approval in principle from the Scottish Executive included a first appraisal summarized in table A (extract). The city also outlined the range of objectives, assessment factors and the type of data they considered necessary in the next stage of appraisal for a detailed business case, as shown in table B. (Edinburgh City Council 2001).

Objective	Assessment Summary
Transport What are the transport impacts of the proposal?	Transport will benefit from a reduction in congestion within the charged area. The investment package will bring major improvements to Public Transport, which will benefit existing users and encourage modal shift from car use. Major benefit.
Environment What will be the impacts on the environment?	The combination of modal switch to public transport, reduction in levels of traffic and reduction in congestion will lead to a reduction in pollution. The investment package will target environmental improvements within the city centre. Moderate benefit within the area of influence.
Safety What will be the effects of the proposal on road and pedestrian safety?	It is anticipated that a reduction in traffic will lead to a fall in accident levels. In addition the investment package will also target improvement in safety for vulnerable users. Major benefit.
Economy What are the impacts in terms of transport economic efficiency?	The model runs using CSTM3 indicate that there is a net economic benefit for all tests of charging options. These benefits are increased when public transport improvements are added. Moderate benefit.
Economic activity What will be the local impacts in terms of employment?	With the current low level of charge proposed it is not anticipated that there will be a noticeable impact. No benefit or impact.
Accessibility What will be the impacts on accessibility?	The investment package will improve accessibility to/from and within Edinburgh. Moderate benefit.
Transport integration What will be the impacts in integrating transport modes and services?	Integration of transport modes and services will benefit from the investment package. Moderate benefit.
Policy integration What will be the impacts of the proposal against wider government policy?	The proposals integrate with wider government policy on health and the environment. Small benefit.

B Summary of factors to be dealt with in the Business Case appraisal for the Edinburgh Transport Initiative

Objective	Global measures	Data
Economic efficiency	Journey time savings Journey time reliability Operating costs Capital costs Charges Taxation impact	Transport modelling Transport modelling Systems development Systems development Transport modelling Financial, Transport modelling
Local economy	Employment changes Spatial economic impacts	Economic model Economic model
Environment	Air quality, Greenhouse gases Pedestrian environment Visual intrusion Loss of green space Noise	Transport modelling Qualitative Qualitative Project definitions Transport modelling
Safety	Personal injury road accidents Personal security	Transport modelling Qualitative
Accessibility	Accessibility measures Severance	GIS/ Transport modelling Scheme assessment
Integration	Transport user convenience Effect on slow modes Integration with land use planning	Qualitative Transport mode Transport modelling, Qualitative
Social inclusion	Effect on income groups Accessibility of deprived groups Regeneration	GIS GIS/ Transport modelling Land use modelling/ Qualitative
Health	Physical fitness/life expectancy	Qualitative
Risk management	Acceptance – public and political Technology and operational risks Financial risk Statutory risk	Consultation Expert advice Financial model Qualitative
Financial framework	Charging revenue Investment cost profile “Non-productive” costs (interest etc)	Transport modelling Scheme timing and cost profiles Financial model

effects on historical buildings and other important cultural objects, land use, economic development, social integration and regional policies, either in money terms or by other quantitative measures. Other countries deal with these factors by qualitative assessment only, which might also include landscape evaluation and the distributional effects of the project.

Appraisal as part of policy development

The appraisal of alternative actions should be seen in the context of an overall process, as recommended in the UK Government Green Book on Appraisal and Evaluation in Central Government (HM Treasury 2003).

Good practice is to see appraisal of public transport projects in the context of policy development, including the whole process of establishing the rationale for action, setting objectives and appraisal of the costs and benefits. As recommended by the UK Department for Transport (2004), the process should also include monitoring and evaluation, the results of which are fed back in to the process. The Green Book aims to make the appraisal process throughout government more consistent and transparent, ensuring that no course of action is adopted without first answering these questions:

- ▶ Are there better ways to achieve the objectives?
- ▶ Does the proposed action provide value for money?

The intention of the UK Government advice is to move away from the traditional “predict and provide” approach to transport problems. This should be replaced by an integrated approach with appraisal of problems, studies of “a full range of options and a comprehensive analysis of the impacts using a consistent approach” (Department for Transport 2004). It is worth taking note of the following points concerning the process of identifying solutions, which should:

- ▶ “be easily comprehensible to those commissioning, steering and undertaking the work; and where possible to a wider public;

- ▶ avoid leading to a particular outcome simply by virtue of the method or process adopted;
- ▶ enable a wide range of solutions and the synergy between combinations of components to be investigated in a cost-effective manner;
- ▶ enable a preferred solution to be developed which addresses the objectives and problems at which it is aimed; and
- ▶ provide a means by which the acceptability of the solution to the public can be tested and taken into account.”

According to the Department for Transport (2004) a study should typically include:

- ▶ agreement on a set of objectives that the solution should seek to satisfy;
- ▶ analysis of present and future problems on, or relating to, the transport system;
- ▶ exploration of potential solutions for solving the problems and meeting the objectives;
- ▶ appraisal of options, seeking combinations that perform better as a whole than the sum of the individual components; and
- ▶ selection and phasing of the preferred solution, taking account of the views of the public and transport providers.

This advice is aimed at analyses for central and local government decisions, but the same critical questions are relevant for a business case study of a private operator or a transport authority. The basic idea should be to provide input to efficient policy development and resource allocation in order to realise the goals of the public transport system in the actual context of the decision makers.



The new tram system in Strasbourg changed the environment and accessibility of modes in some of the major shopping streets in the city centre. Before (above) and after (below). PHOTOS: CITY OF STRASBOURG / GUSTAV NIELSEN

4.2 Planning public transport and urban structure

The interaction between the public transport system and land use is the topic of HiTrans Best practice guide 1. Urban design is dealt with by guide 3. Consequently this section on analysing the relationship between public transport planning and the wider aspects of land use and transport planning is rather brief.

Models fit for purpose in medium sized cities

For the long-term land use planning it is of course possible to use very advanced and comprehensive planning methods, such as (rather) complete four-step models (so called nested logit model systems), land-use-transportation interaction models or other types of advanced model systems. This is sometimes done in the larger cities.

What would be appropriate methods and tools for the medium sized cities with few resources for large-scale comprehensive models? Good practice in the use of tools is explained for the following planning tasks:

- ▶ Identification of deficiencies in accessibility, travel time, etc provided by the land use and public transport system
- ▶ Corridor analysis of land use and public transport network
- ▶ Location analysis of major public transport interchanges.

It should be remembered that there are interactions between land-use and transport accessibility. Improvements in accessibility will have the effect of increasing land values and these in turn will have an impact on transport planning. Whilst it is difficult to identify the exact change in land values, in broad terms those people living in more accessible locations will be the gainers. Accessibility is generally a determinant in the location of firms. New transport infrastructure that improves accessibility is often an incentive for new business activity.

Finding the gaps in public transport provision

Quite simple travel time analyses and accessibility analyses can be carried out to answer questions such as:

- ▶ Where to put in a better public transport system?
- ▶ Between which origins and destinations are the average travel times at peak and off-peak hours inordinantly long in relation to the CBD distance? or
- ▶ From which areas is the accessibility in terms of the number of work-places within, say 45 minutes by public transport too limited in comparison with local goals?

The theoretical basis and mathematical techniques for this type of analysis have been available for many years. But it has taken long time for the development of sufficiently detailed and updated databases on land use and the transport system for the approach to come into common use in public transport planning for medium sized and smaller cities.

With the introduction of full scale geographical information systems in public planning, in combination with software packages, such as Arcview/Arcinfo and many other commercial programmes, this type of analysis has become much more common and useful. Also, a new method, Geographically Weighted Regression (GWR; Fotheringham and Brunsden 2002), is capable of looking at whether the public transport system, for example, causes changes in property prices using factors such as accessibility to the city centre. The relative importance of each observation in the data set can be shown on a map.

These tools are useful for the study of geographical accessibility. They may assist decisions on location of new land use functions or on improvements in public transport services and infrastructure. But they are explanatory rather than predictive. So if changes in infrastructure are proposed, it is important to use some sort of transport model to predict the pattern of demand (in terms of origins and destinations) that might change.

Example of a generalized time analysis

An analysis at the network level for the planning of an upgraded bus network was carried out by the Traffic Department of the Stockholm County Council. Generalized time consists of the users' perceived travel time, i.e. the sum of weighted travel time components. The basis for such weighting is mentioned in chapter 3. In this example, they are:

- ▶ In-vehicle time * 1
- ▶ Walk time * 2
- ▶ Wait time * 2
- ▶ Number of transfers: + 5 minutes/transfer.

The question to be answered was, in which origin-destination pairs is the total perceived travel too long, and the total number of trips above a certain threshold? The answer should indicate the need and potential for new or improved bus lines in the transport corridor under study.

The study was carried out by using a network analysis programme and by producing a sorting list for each geographical sector. The following type of table was produced. For pairs of origin and destination zones the table

shows the motorised travel demand and public transport service quality expressed as generalized time.

The table results were also presented on maps, giving indicators to the practical planners about those origin and destination pairs that needed most improvement. Informed by this, the planners could draw up proposals for new bus lines, and a new calculation of generalized time could be made to test the effect of the new lines. In a second step the generalized travel time gains were compared to the annual operating and capital costs of providing the new lines. A simplified form of cost-benefit analysis was carried out at the bus line level.

The method was successful as more than 80 percent of the ranked, prioritized and proposed new bus lines were introduced within the five year budget of the public transport company.

Origin zone	Destination zone	No. of car + public transport trips	Walk time	Wait time	In vehicle time	No of transfers	Total generalized time	Rank from worst to best
A	B	75	10	15	25	2	135	1
A	C	80	15	10	25	1	130	2
B	C	120	20	5	20	1	125	3
C	D	300	15	5	25	0	105	4

Example of an Accessibility Analysis

An accessibility model can be used for the definition of areas most suited for the location of different types of businesses, as suggested by the Dutch ABC-location policy – putting the right business in the right place in relation to the transport system. This example is from an application in Trondheim, Norway. (Asplan-Viak 1999).

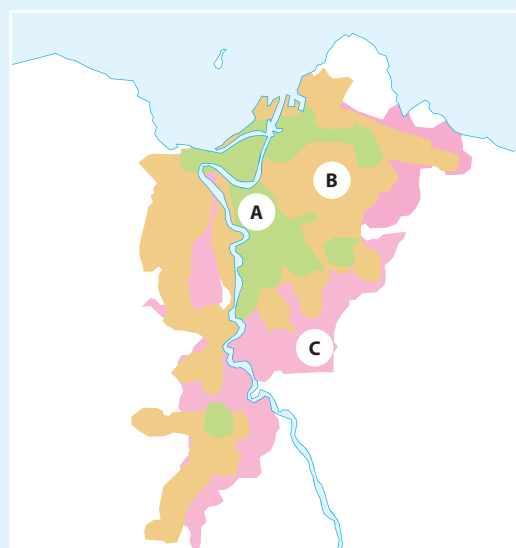
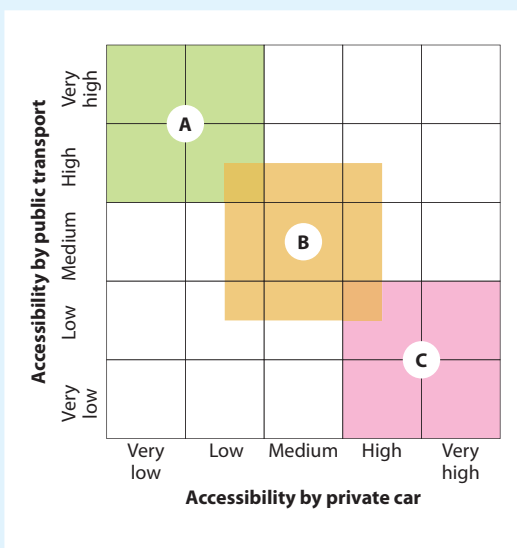

1 The Dutch ABC-Principle for the definition of different accessibility zones in an urban region categorised by a combination of accessibility by car and public transport. Zone type A will typically be a city centre well serviced by public transport and with strict regulations over car parking. Zone B will typically be a local centre or concentration of work places in the main city, with fairly good accessibility by public transport and some restrictions on car parking. Zone C would be other parts of the urban region with very good access by car, and a less developed public transport service.

2 The ABC-zones defined for the City of Trondheim, Norway were created by using a geographical accessibility model. The location of work places in Zone A would maximise the demand for public transport and minimise the use of car by workers and visitors.

Corridor analysis

Corridor analysis is often used for the study of a new proposed public transport line or project. A new light rail line can be taken as an example.

The proposed design of a line depends on the topography, geology and other land constraints, as well as the number of residents, workplaces and other service and activities to be served by the proposed line. The design and layout of the project is often a compromise between a route as short as possible (a straight line between A and B) and the need to cover as many activity points as possible on the way.

The investment and operating costs have to be balanced against travel time savings, ticket revenues and other sources of benefits (e.g. environment and traffic safety gains).

At an early stage of planning the project, such a study can be carried out by using a simplified network analysis, in which the planner only considers the line distance (total and between stops), speed and travel time with average frequencies.

The early stages of the Stockholm Tvärbanan, a tangential light rail line now in successful operation, were originally planned by this “corridor method.”

Location of major interchanges

Location and design of major interchanges is often of utmost importance for the functionality of public transport services. Such a complement to the corridor study might contain the following aspects:

- ▶ Number of passengers affected
- ▶ Transfer time
- ▶ Change in accessibility.

It is often difficult to replace direct buses, for example radial lines from a suburb to the city centre, by a feeder bus plus a rail mode. This would save bus vehicle-kilometres, but it imposes an extra transfer on the travellers. The benefits for travellers using the new rail facility have to be compared to the disadvantages for the passengers coming from the outer part of the region, now without the direct bus connection to the city centre. The reluctance to change vehicles is a key issue in this type of analysis.

4.3 Planning for the long term

At the strategic planning level it is important to judge the market for new or altered public transport services. The task might even be to estimate the impacts to the society of an entire new public transport network.

The demand for a public transport line in an urban area is highly tricky to capture at a reasonable level of certainty. Investment and operating costs are usually of a significant size, when considering the whole economic lifetime of the project (often 30–40 years or more). The demand is highly sensitive to the local competition from other modes of transport, such as walking, the bicycle and the motorcar. Therefore there is a need for a detailed assessment tool to ensure that benefits are reasonably correctly estimated.

Tools for the long term analysis

We will discuss the following types of strategic planning analyses:

- ▶ Public transport network analysis
- ▶ Studies of transport mode choice
- ▶ Elasticity models for the analysis of changes in services or prices
- ▶ Cost-effectiveness analysis in relation to specific objectives or business results
- ▶ Cost-benefit analyses of investment projects and other changes in the public transport system, including external effects.
- ▶ Multi-criteria analysis.

Often in practice the analysis is part of an application for central government support of a public transport project. In these cases the planner must refer to national planning requirements, which may be statutory. Some references are given in the reference chapter at the end of the guide.

Network planning models

Some decades ago, transport projects were usually assessed by corridor studies (as mentioned earlier in the chapter). This implies a rather detailed study along a proposed bus or rail line. However, people do not move along corridors only. Besides, in dense urban areas different public transport lines are linked

in a rather complicated network. In such networks lines can be more or less coordinated; feeder bus lines are connected to radial or tangential rail lines, and so on.

Some 30 years ago, computer based network analysis programmes emerged in the transport market. First as rather crude extensions of the earlier transport models developed for the planning of roads for car traffic, these later developed to better simulate the specific characteristics of public transport operations, supply and demand. Programmes such as VIPS, TRIPS, EMME/2 and later VISUM are examples of such network analysis tools.

Inputs to network analysis programmes are:

- ▶ A detailed coding of the transport network, defined by traffic zones, centroids, links and lanes, nodes and junctions, with modes and public transport lines.
- ▶ A representation of the demand for trips, such as pedestrian, bicycle, car and public transport modes.
- ▶ A network assignment procedure, by which trips are assigned to the network lines (in the case of public transport) according to some behavioural rules.

Typical outputs from network analysis models are:

- ▶ Total number of public transport trips, by mode, such as bus, light rail, commuter rail, metro etc.
- ▶ Public transport traffic flow by line or line segment
- ▶ Travel time by public transport modes between zones and stations (total and often also by component, such as walking, waiting, in-vehicle and transfer time)
- ▶ Public transport passenger loads and passenger-kilometres
- ▶ Number of boardings, alighting and transfers by line or by stops.

By comparing a base scenario to some alternative solutions studied, differences in patronage, travel times, accessibility and other line performance indicators can be derived.

The importance of detail in network analysis

Two different studies of the same project were carried out: a detailed study in 1988 of the proposed new tangential light rail system for Stockholm, and a “quick and dirty” study in 1991.

The detailed study in 1988 showed that the demand for the new light rail service was, let us say, index 100 trips. In the 1991 study the number of trips only reached index 30 trips, i.e. one third of the number of public transport trips as predicted in the more detailed study.

The large difference in result was due to the different level of detail in the coding of the new tramline and the connected public transport network. In the 1988 study Transek Consultants conducted an in-depth demand analysis for the new light rail line, using a detailed network planning method (EMME/2). The demand analysis was made during a three month period, with splitting traffic zones into more detailed zones, and a detailed

coding of walking connectors from residential areas to the light rail stops.

Three years later the same light rail line was to be coded into the same network analysis programme in 3 hours as part of a regional development plan. There was no time for a similar, detailed and exact coding of walking connectors to the network as in the first study. And the result for the new tram line was rather depressing.

The story ends with the light rail line being built and becoming a large success in the transport market of the Stockholm region (see earlier example of the time series analysis in Stockholm County 1997–2001).

The comparison between the two studies illustrates the crucial role that a detailed public transport network analysis can play in strategic public transport planning.



Stockholm Light rail, “Tvärspårvägen”. PHOTO: GUSTAV NIELSEN

Example of a network problem

A typical situation where a clear “network effect” might occur could be a metro or light rail extension to a suburban rail station, around which there is no substantial residential or employment activities concentrated. A simpler corridor study would not detect any new rider-ship in this case. But with the network approach, new opportunities to transfer from rail to metro or light rail will be made possible through this new transfer point. Only a proper network method can identify the full benefits in such a situation.

Assume a new light rail line in an existing city where a lot of bus lines are operating. The competition from the walk, bicycle and car modes also has to be taken into consideration. The demand for the light rail line might vary largely, depending on:

- ▶ The station spacing and thus the walking distance

- ▶ The LRT Speed
- ▶ The LRT frequency of service
- ▶ Accessibility at the interchange points.

The old 4-step model is nowadays being replaced by the new “nested logit model system” (still often consisting of 4 steps, but better linked together). Compared to the traditional mode choice model, this more sophisticated modelling answers the following questions:

- ▶ How many trips are generated from this area (“frequency choice”)
 - ▶ Where does the trip go? (“destination choice”)
 - ▶ Which mode is used? (“mode choice”)
 - ▶ Which routes are used? (“route choice”, “line choice”)
- Another, fifth choice, is sometimes added:
- ▶ When does the trip take place? (“time-of-day choice”)

How much is an in-depth study worth?

Consider the total costs for a 10 km light rail line during its full economic lifetime, 40 years: The investment cost can be estimated to some €200 million. The operating cost may be a little less, or €170 million. This means that the cost will be €370 million altogether.

Assume that a proper in-depth transport demand and supply analysis could save only 1 percent of the total costs, or improve the difference between revenue and costs of the same order.

Would it not be worth to spend one tenth of the cost saving, i.e. 0.1 percent of the total cost, on an in-depth travel demand-supply study? If your answer is yes, you should have €400,000 to use on this study before you start implementing the project.

Advantages of network models

The advantage of this more elaborate model system is quite obvious. It becomes much more realistic as it gives answers to most of the trip decisions that takes place in reality: "I have decided to travel by bus from home to work this morning in the peak hour by bus line no. 1 to the city centre". Compared to the single mode choice model, the "nested logit model system" is more realistic and produces much more detailed results. This model is also based on sound individual behavioural theory, for instance by explaining why individuals may decide to take a longer journey rather than make a transfer.

The model output can be presented in terms of traffic flows by car and public transport modes for the entire region, but also for specific lines, routes, links and junctions at the detailed level of the network. Most commonly it also contains a network assignment model for the route choice problem.

The disadvantage is similar to the mode choice model: there is an obvious need for either in-house or external support in terms of computer programs,

data, skills, detailed network coding and travel forecasting procedures.

How much detail is needed in medium-sized cities?

Which method should be recommended for medium-sized cities? There is no single, clear-cut answer to this question. The answer depends on the available resources, the time available for the decision-making process and the quality of available data. It is also important to consider how many transport projects are to be investigated, how large and costly these projects are, and how much reduction in uncertainty the planner believes could be achieved by applying a better tool.

One might start looking at the possible gains of better decisions on a single, but large public transport investment project. However, in all medium sized cities the development of the public transport system is an ongoing process, in the same way as the operation of roads and other public services in the urban area. The public transport network will have to develop according to city development, transport market changes and new, and possibly more ambitious, political objectives, as well as adjust to changes in economic realities concerning public support and possible income from the fares. Having a good analytical tool in the form of a updated and professionally operated public transport network model should be considered a small investment in future cost-efficiency and market success. It will probably also serve as an insurance tool to avoid some directly erroneous judgements and counter-productive decisions.

The recommendation for good practice is to use a good network planning tool in order to reduce the uncertainty of all significant projects.

This can be done as in the case mentioned above, by carrying out sensitivity analyses. As an example of such sensitivity analyses, the following list has been proven useful:

- ▶ Vary the amount of residents and workplaces to be served (land-use plans and reality might change over time)

- ▶ Vary the headway of the proposed service (this shows how robust the demand is for supply changes)
- ▶ Vary the station spacing (if, suddenly one neighbourhood unit were to be not developed)
- ▶ Vary the ticket price for the public transport service studied (showing how price sensitive its demand is)
- ▶ Vary the interest rate in the economic net present value calculations.

Such sensitivity analyses reveal, in an efficient way, how robust the public transport project will be in the face of various uncertainties.

A network analysis programme needs to be linked with a demand model, preferably including at least the following steps:

- ▶ How many trips? (trip frequency choice)
- ▶ Where does the trip go? (trip destination choice)
- ▶ By which mode does the trip go? (modal choice)

The route choice decision is handled directly by the network analysis programme.

Modelling choice of transport mode

If the level of ambition is lower than indicated above, a simpler way to make an assessment might be to adopt a mode choice model only. The mode choice model is a very commonly used transport model in public transport planning. The models have been in use for more than 40 years, and they use a rich set of variables. Often they contain three different kinds of explanatory variables:

- ▶ Socio-economic factors describing the characteristics of the household or individual (e.g. gender, age, income, occupational status)
- ▶ Mode competition factors for the household or individual (e.g. car and bicycle competition and availability within the household)
- ▶ Mode characteristics of the competing modes, such as travel time components, travel costs, indicators of service quality etc.

Mode choice models can be applied either at the aggregate level for the entire region, at the city level or at the more detailed network level.

What can a network and transport demand model be used for?

The Swedish SAMPERS system is an example of a nested logit network model system. It can be used for a wide range of planning issues, from evaluation of national policies to project analysis at a detailed network level. This includes:

- ▶ Demand effects of new infrastructure and new services, both for single projects and for comprehensive investment programs
- ▶ Demand effects of changing incomes, different population structure, changes in trade and industry etc.
- ▶ As a basis for calculation of traffic safety effects
- ▶ As a basis for calculation of environmental effects
- ▶ As a basis for calculation of energy consumption
- ▶ As a basis for calculation of accessibility effects
- ▶ As a basis for calculation of regional effects
- ▶ Effects of transportation policy like taxation, tax deductions, road pricing, area licensing, road tolls, rules for company cars etc.

(Source: Beser and Algers 2002)

Usually this type of model has many variables explaining the mode choice. This is of course a great advantage, as the specification error might be low. On the other hand, the disadvantage with mode choice models is that they have to be estimated on a similarly rich database.

Normally the transport models do not include factors such as service quality, reliability and punctuality, information and similar 'soft' factors. However, recently, various efforts have been made with the application of Stated Preference methods and results from such methods have been used to complement to the more traditional transport models. One such example was the new tangential LRT line "Tvärbanan" in Stockholm. There the higher level of vehicle comfort and convenience was calculated ex ante to increase the users' willingness-to-pay for the new LRT line with some 30 percent of the ticket price.

Another example can be found from the field of Personal Rapid Transit (PRT) from the EDICT project (www.edict.info) From its Stockholm application with a PRT network connecting Skärholmen to Kungens Kurva Commercial Shopping Mall, the

comfort and convenience factors were estimated to correspond to 79% of the ticket price (based upon previous stated preference study results). In the demonstration test Site of Cardiff Bay with the ULTRA PRT system (www.atsltd.co.uk) running since 2002 with test passenger trials, the estimated willingness-to-pay was 80% higher than the Cardiff bus ticket price of £1.

There are two ways of obtaining a good mode choice model. One way is to develop a new "local" model that is estimated using local data from the area of the proposed project. This can be achieved by implementing a tailor-made travel survey for this purpose. Another way is to import a good model from another city or region, and just make a specific adjustment so as to correct for differences in the socio-economic structure between the two regions. There is a special technique for this called "model transfer".

The recommendation for medium-sized cities is thus, that at least an in-depth mode-choice model analysis should be used in assessing strategic and even minor public transport projects.

Elasticity models

The elasticity method is a simplified technique, most often derived from a transport network or time-series model. The elasticity figure expresses by how many percent public transport ridership changes if one of the explanatory variables changes by 1 percent.

The advantage with this technique is that it is simple to use. The method can be used to predict the impact of both price changes and supply (service) changes in the public transport sector. As the elasticity summarizes the full demand curve, at least at one point on the curve (normally at its average value, the point elasticity), or between two points at the curve (normally the 'before and after' situation; the so called arc elasticity), this measure thus corresponds much better to the "true" valuation of the users (provided the demand model is of a good quality). One might label elasticity as an "intelligent rule of thumb" method.

Usually, the elasticity models are quite valid for changes in supply up to +20% to 30%. At changes larger than 10 percent, the arc elasticity concept should be used instead of the point elasticity concept.

However, with simple methods it is critical to carry out sensitivity analysis. This involves looking at the outcome of a change of 0.75% or 1.25%. In this way, a simple method can be used with some confidence if the outcome is not sensitive to changes about the key assumptions. With sensitivity analysis, changes of up to $\pm 20\%$ of the base assumptions should be examined.

The disadvantage of using the elasticity measure can be that it is too often taken from a different time period, city or country, where the circumstances on which it was originally estimated are much too different from one's own application. In such cases the elasticity models should not be used.

The Transport Research Laboratory (2004) gives a very useful overview of the empirical research and model studies and their conclusions about the various factors that influence the demand for public transport, including methodological discussion and advice. However, a very substantial part of the research data is from British cities. Although many comparisons are made also with research and data from other countries, the British public transport system, and institutional framework (on the road competition outside London) is different from the situation in Scandinavia and on the European Continent. There is also much less empirical evidence from small and medium sized cities. Local and national research on the topic of urban transport demand should be consulted when HiTrans cities are developing their transport solutions.

Learning from impact studies

In some cases, a source of information might be the reported results and experiences from other places. However, it is not always easy to see if the results reported are real effects of the measures carried out. Many complex interactions take place in a city when the transport system or some transport policy factor

What do real world experiences tell us?

Some Swedish studies show the following results:

Measure	City	Effect on PT ridership	Other
Trunk bus lines	Jönköping (SE)	+ 10%	+14% ticket revenue
Trunk bus lines	Stockholm (SE)	+ 80–210%	
Demand responsive bus service	Höör (SE)	+ 55–70%	
Demand responsive bus service	Sigtuna (SE)	+ 55–80%	
Demand responsive bus service	Grenå (DK)	+ 300%	
Demand responsive bus service	Helsingborg (SE)	+ 44%	
“Flexibus” in four suburbs (1996–2002)	Gothenburg (SE)	+ 217%	37% reduction in taxi trips by disabled persons
Coordinated school bus service and line haul traffic with special service for disabled, plus free trips	Ockelby (SE)	+ 170%	

Source: Transek

changes. Also uncontrolled, external factors (e.g. demographic and economic changes, shifting petrol prices, strikes, special travel demand occasions, etc.) will often influence the parameters of change and the indicators of success that are used. Finally, there is also the problem of transferability of results from one city to another, perhaps also in a different country.

Cost-effectiveness analysis

Cost-effective analysis is a very useful method aimed at sorting out which of many alternative public transport projects (in this case) yield the highest performance per invested unit of money (investment and operating costs).

“Performance” must be analysed in relation to clearly defined objectives for the transport system. In chapter 3 the topic of different goals, objectives and indicators is discussed. As indicators of success

or failure one could measure performance in several different ways, such as:

- ▶ Number of new passengers
- ▶ Number of new passenger-kilometres
- ▶ Number of saved “generalized time” hours per passenger
- ▶ Ticket revenues.

All such measures should then be calculated per annual cost unit. Or the cost-effectiveness measure can just be expressed as cost per new passenger or cost per passenger-kilometre. By comparing various project proposals against each other, the decision-maker can choose the project that yields the highest performance per unit of money spent.

Cost-benefit analysis

Cost-benefit analysis is the most widely used assessment method in transport studies where the public sector involvement is at stake. It rests on a fairly

Example of results of a cost-effectiveness study

A Swedish research project used calculations of cost-effectiveness in order to compare different types of public transport projects that have been put into operation in some Scandinavian cities and analysed their effects on public transport demand. The main results were presented by showing the costs per new passenger as indicated in this table. The measures are ranked with the most efficient measures at the top:

Measure, city	Cost-effectiveness Euro per new passenger
Trafikanten traffic info centre, Oslo	*
Increased train frequency, Stockholm	0.07
Combined package, Kristiansand	0.34
Flexible bus service, Gothenburg	0.35
Trunk bus line, Stockholm	0.36
Reduced fares, Kristiansand	0.37
Demand responsive bus service, Grenå	0.48
Direct marketing campaign, Sundsvall	0.52
Combined package, Drammen	1.17
Zero fare, Kristinehamn	1.38

* The study indicated that this measure generated much more traffic and revenue from fares than the total cost of operation.

The results of the study are specific for each city and measure carried out, and cannot be directly used for public transport planning under different circumstances. But with detailed knowledge of the context and design of the measures, this type of information is potentially very useful for policymaking.

well defined scientific technique. CBA answers the question: how large are the benefits to the society compared to the total costs for the society of a certain project. The Net Present Value is calculated by bringing the value of future flows of costs and benefits back to the present day so that schemes can be compared.

The CBA technique requires knowledge and data for quantifying and measuring benefits (in terms of travel time, traffic safety and environmental savings) in monetary units to be compared to costs. Many CBA studies have a qualitative presentation of plus and minus factors that have not been expressed in money terms at the end. CBA also requires a certain level of professional skill to apply the method properly.

In many European countries governments demand a well-defined CBA to be carried out, as a pre-requisite for obtaining national grants to cover some or all of the capital costs associated with the public transport project.

With the CBA method two types of questions can be answered:

- ▶ When comparing various alternative proposals within a fixed budgetary constraint. Here the procedure is to ensure that the expenditure is most appropriate. To begin with, the project with the lowest capital outlay and decide whether this is worth undertaking (is its benefit/cost ratio greater than 1?). The next stage is to look at the additional benefits and additional costs of the next most expensive project within the budgetary limit and ask if the extra money should be spent (is the benefit/cost ratio of the extra money greater than 1?). If so, it should then be preferred from the economic efficiency point of view.
- ▶ To decide whether a public transport project is worthwhile the expenditure of public resources or not. The decision rule is such that the public transport project should be recommended (from the economic efficiency point of view) if and only if its benefits exceed the costs.
- ▶ When comparing various alternative public transport projects within a fixed budget. Each project

should first be evaluated to see if its benefits exceed the costs. Then the various combinations of projects which are recommended can be examined to see how the net benefits can be maximised.

Usually, not all relevant factors can be included in the Cost-Benefit Analysis. When this is the case, there is a need for a broader assessment method and sometimes a list of factors that the decision maker should take account of qualitatively by awarding positive or negative assessments to elements such as, for example, damage to wildlife.

Dealing with intangibles

All factors that affect public transport cannot always be analyzed using analytical models. This might be the case when there is a lack of adequate data, or simply because the factors at stake cannot be represented in the available models or methods.

Some fifty years ago, only investment and operating costs were considered when evaluating a new public transport scheme. Since 1965–1970, travel time and its components have been taken into consideration. In the early 1970s in Stockholm County Council, the major decision rule at the Board of the Public Transport Company when opposing a proposal for a new transport service was: “Not motivated from the point of view of capacity need at peak periods” (Swedish: “Icke-belastningsmässigt motiverat”).

During the second part of the 1970s the Generalized Time and Generalized Cost Concept came into operation. During this period one of the first computer program for route network planning method (VIPS) was used in public transport planning. In those days, comfort and convenience aspects were “intangibles”. During the 1980s and 1990s intense transport research was devoted into the users’ behaviour and attitudes towards stations/terminals and vehicle comfort evaluations, mostly using stated preference techniques. Examples of such research progress are evaluations of:

- ▶ Seating comfort
- ▶ Real time information at platforms

- ▶ Air conditioning on board
- ▶ Cleanliness at stations and in vehicles
- ▶ Lifts at stations
- ▶ Weather shelters

All such factors were earlier considered “intangibles”. Nowadays, the intangible benefits are also studied by focus group interviews. Focus group methodology is an in-depth interview technique in which a fairly small panel of people answer questions and participate in a guided dialogue with a moderator, in order to find out which factors are most relevant and important.

Of the wider factors that often have to be included in the CBA analyses, safety and environmental issues are highly sensitive to value judgements and difficult to quantify in money terms. Questions about the value of life, clean air and peacefulness open up a wide field of inter-professional and political discussion that cannot be taken up here.

Multi-criteria analysis and appraisal summary

Multi-criteria analysis (MCA) is a somewhat broader concept than cost-benefit analysis. It is increasingly used as MCA can handle factors without having to apply as many monetary evaluation values as CBA. The method applies various weights to factors used in the evaluation and these are often derived by reference to the subjective judgements of experts or political panels.

Another way to provide a broader assessment framework to the decision-maker is to create an “Appraisal Summary Table” (ATC). This is often used in the United Kingdom by summarising all relevant factors affecting the public transport project at stake. Factors that can be both quantified and monetised are presented in monetary values, while factors that can be quantified, but not monetised, are expressed in physical units, e.g. number of traffic accidents (by severity), or tonnes of CO₂ etc. Factors that cannot be quantified may be expressed in qualitative terms, such as: “the visual intrusion is regarded to be severe”; “land values might be enhanced substantially” etc.

Example of the use of focus group interviews

Focus group interviews may be used to inform transport decisions on matters that are difficult or impossible to quantify. For instance, the potential user acceptance and evaluation of completely new concepts of public transport systems or elements can be explored.

In Sweden, a user acceptance study on a proposed Personal rapid transit (PRT) system in Kungens Kurva was carried out at Huddinge in October 2003. 28 persons who often visit Kungens Kurva, using a variety of different transportation modes, participated in group discussions with the aim to study potential travellers' attitudes, acceptance and willingness to pay for a PRT. The results could be summarized as follows:

- ▶ It can be difficult to travel to Kungens Kurva and troublesome to get around in the area. Public transport users complain about long distances between shops and that the area is not very nice to walk around in.
- ▶ 80% of the public transport visitors claim that they would visit Kungens Kurva more often if it was easier to travel to and within the area, while the number of car users with the same opinion is rather low. Just over half of the car users would visit more shops if it was easier to travel between them.
- ▶ All participants were curious about a PRT in Kungens Kurva and they would travel at least once on the system if it existed. Few car users said that they would change from car to public transport when visiting Kungens Kurva, but they would consider using the PRT to get around between the shops.
- ▶ The public transport users were most positive towards the PRT. They also indicated the highest willingness to pay for travel on the system. 39% were willing to pay between €0.5 and €1.5 per trip. A few car users were willing to pay for travelling on the system. But most of the car users thought that the shop owners would gain most from the system, and that consequently the shop owners should pay for the operation and maintenance of the system.
- ▶ The informants were shown photo sketches of the new system on beams and pillars through the area, and expressed attitudes such as: "Visual intrusion

is not a trouble – the PRT is, if anything, a positive visual experience". "It is fun to ride upstairs". "The cars looked "smart", like science fiction. The children will love it."

- ▶ The study also indicated that reliability in the technical operation is very important. There was less anxiety about the personal safety in the automatic system. To have a future, the PRT will always have to be working and kept clean. If there are a lot of complications the system will get a bad reputation and no one will use it.
 - ▶ Only a few people asked questions regarding the personal security in the PRT cars and at the stations. As long as a lot of people are moving around at the times they visit Kungens Kurva, and if there are security cameras and the possibility to choose the accompanying passengers, security was not considered a problem. The short travel time and short distances between the stations would result in a feeling of security, since the traveller would not have to spend long times in an unpleasant environment. The most unpleasant possibility would be a failure in the system.
- The main lessons from this focus group study were:
- ▶ **Visual intrusion was not regarded as a major problem with PRT**
 - ▶ **Personal safety and security was not regarded as a major problem with PRT**
 - ▶ **The technical reliability was, however, regarded as very important. A new means of transport must function well and be kept clean, so as to avoid bad reputation.**

Source: Transek/EDICT 2004

4.4 Planning in the short term

Short-term oriented public transport planning is just as important as the more medium-term and long term planning issues. It is therefore good practice to devote proper efforts to this form of public transport planning.

Different types of analysis

The following four fields of short term public transport planning are discussed:

- ▶ Market analysis through the use of various forms of consumer market research and time series models in order to understand customer behaviour and the influence of external factors.
- ▶ Studies of the effects of changes in services through cost-effectiveness analyses and generalised cost and time and elasticity models.
- ▶ Studies of the effects of changes in prices and fare structures by the use of similar methods as for service changes.
- ▶ Operational planning for timetable, vehicle and crew scheduling.

Consumer service investigation

An increasingly popular method of assessing the performance of the public transport services is the so-called Consumer Satisfaction Index (CSI). A panel of respondents (public transport passengers but also non-users or other residents) is questioned about many aspects of the performance of the bus and rail services in a city.

A drop in the rating of a certain factor during the last quarter of a year is often a good indicator that some sort of action to improve the service should be immediately undertaken. It could be driver behaviour, the fare level, cleaning or travel time reliability.

The absolute level of satisfaction with different quality factors may also be taken as an indicator of which aspects of the service should be given priority in the development of the system.

However, one should be aware of the fact that there is no simple correspondence between consumer satisfaction and public transport ridership. On the contrary, a study of the consumer satisfaction index (CSI) and the public transport ridership

in Sweden 1996–2002 found that since 1999 public transport trips per inhabitant increased by 7 percent. At the same time, the consumer satisfaction index (CSI) dropped by 8 percent. The conclusion was that the CSI is not a good predictor of the changes in the demand (Transek 2004).

Neither is it possible to draw any significant conclusions from comparisons between the scores in different cities, even if one takes good care in the translation of questions, the standardisation of data collection techniques and respondent selection.

The attitudes measured in such surveys are dependent on a number of different cultural, historical and personal factors, the respondents' former experiences and existing expectations. This means that comparisons between results from different countries and cities have little value, although different trends in the results over time may justify some conclusions concerning which city is doing better than the other.

Causal models

These are models that bring together information of public transport ridership on a monthly or annual basis with a set of explanatory factors. The aim of using time-series models is to explain which factors affect variations in the number of trips by various public transport modes. The models can also be used to judge how much each factor influences the trip rate.

After such a model has been estimated for an area, it can be utilized for follow-up purposes on a monthly (or annual) basis. The model can also be used for short-term forecasts of the transport market in the region.

A special application is to analyse the results by grouping the explanatory factors into the following types of variables:

- ▶ Factors easily influenced by the public transport authority (such as fares, supply, information etc.)
- ▶ Factors not easily influenced by the public transport authority (such as population, employment, car competition, petrol prices, weather conditions, annual variations etc.)

By separating these two groups of factors from each

Example of results from an international customer attitude survey – BEST 2001–2004

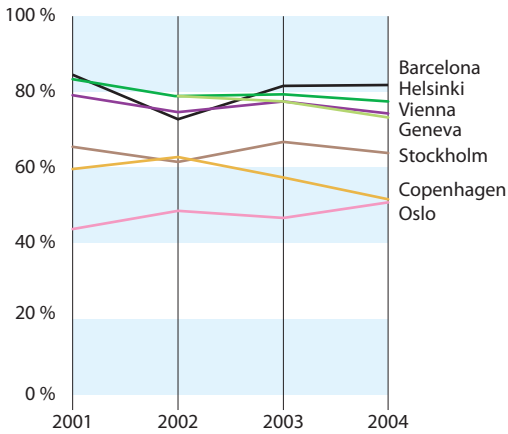

Helsinki score in 2002 compared with other cities

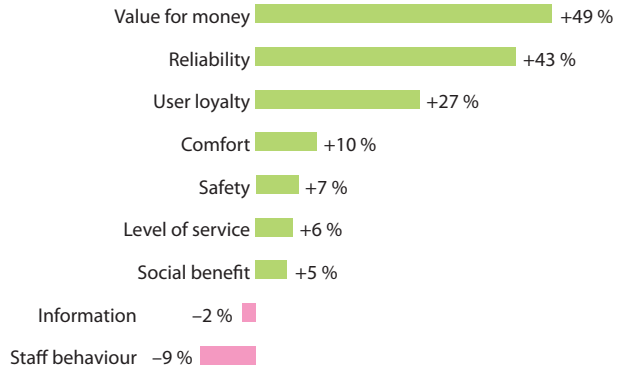

Left: Percentage of inhabitants satisfied with the public transport system.
 Right: Results from 2002: Helsinki score on different quality factors compared with the average results of the other cities. Based on interviews from a random sample of inhabitants in the city communities. (Source: Tengblad 2004 and Helsinki Public Transport 2002)

Example of results from a time series model

The figure shows the good correspondence between observed and modeled estimated public transport trips for Gothenburg 1996–2002. Results were obtained from a non-linear time-series model. (Source: Transek 2004)

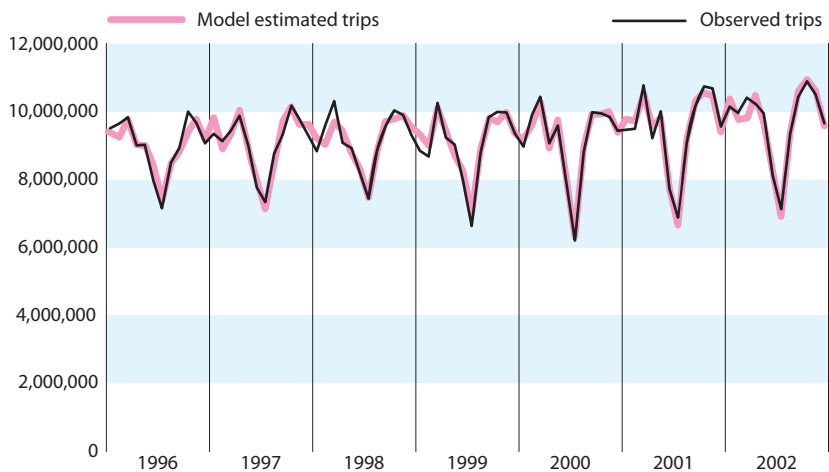

other, the public transport planner can evaluate and compare with the previous year's performance of the transport service, and distinguish the impacts on ridership between internal and external factors, which otherwise would be impossible from pure trip records only.

A typical database for a time-series model contains the following types of factors:

- ▶ Traffic system factors (fares and vehicle-kilometres provided etc.)
- ▶ Overall urban activity (population employment, unemployment, retail sales, other economic indicators etc.)
- ▶ Indicators of competing modes (car ownership, petrol prices etc.)
- ▶ Special events within the public transport system (such as major network changes, new fares systems, larger marketing campaigns, new types of vehicles etc.)
- ▶ Factors explaining the seasonal variations in ridership (weather variables, holiday and school semesters etc.)

Important results from time-series models are demand elasticities for all variables in the model. These elasticities can be used for both tactic and strategic public transport planning.

Operational planning

Operational planning in a public transport company usually covers three main fields of planning.

Operational route planning includes the detailed choices of the different lines' route, start and end, the stopping pattern, the frequency of departures, and the timetable. These often need co-ordination with other lines and modes. Extra time at the end of the lines must be provided in order to adjust timing after traffic disturbances. Many of these variables might vary according to the time of the day, week-day, month and season, but here there is a trade-off between simplicity for the users, information needs, and efficiency in the use of resources. For rail systems, rail capacity, the existence of single track sections, etc., must also be taken into account.

The interplay between this operational, short term route planning and the strategic long term planning of the network as a whole is a crucial connection between policy and implementation.

Vehicle allocation planning determines how the available vehicles in the system will be used on different lines and work shifts. This planning must cater for the various types of vehicles needed on different lines and times of the day, and consider the need for preventive maintenance at regular intervals. Also strategies for the handling of unplanned vehicle breakdowns and delays must be prepared. The geographical structure of depots, maintenance workshops, etc., will have an impact on the amount of "unproductive" vehicle mileage and driver hours, and the solutions chosen.

Personnel and shift planning deals with the organisation and deployment of drivers and other personnel to the different lines and departures over the working day. This planning must take account of work time regulations, industrial law, and agreements with labour unions, and should be carried out in close co-operation with the employees. Monthly or bi-monthly work plans, prepared at group and individual level, are needed to take account of the same aspects and also include time for on-the-job training, sickness leave, holidays, etc.

All these aspects will influence the efficiency and costs of operating the public transport system. When there is competition for tenders of operation, and/or incentive contracts, the operator will have a strong motivation to do a good job in this complex task of technical and manpower planning.

Nowadays most of this planning is aided by the use of specialized planning software. But having good labour relations and a detailed understanding of the local practicalities of the system are also important for the task.



Glossary

Appraisal is the process of assessing the worth of a course of action, which includes projects, programmes or policies.

Evaluation is similar to appraisal, although uses historic data and takes place after the event.

Franchising A form of tendering covering a spatial area in which the franchisee is protected from competition in that area.

Gross cost service contracting A form of tendering of single or bundles of routes where all fare box revenue is kept by the tendering authority.

Headway The gap (measured in time) between successive public transport vehicles.

Interchange A physical point of transfer between one or more modes of transport. Although the term is normally associated with bus or rail terminals it can also be applied to a bus stop.

Line In this guide, the term line refers to the operational element of the public transport system, as opposed to the route (see below) that the buses or rail vehicles follow through the city. This distinction between the term line and route is also made in Scandinavian and Continental professional practice. Although not in common use when describing bus networks in English, "line" is also used for rail services in the UK, such as the different lines of the London Underground. In rail systems the operational term line should also be distinguished from the infrastructure term of rail track, even if common English often mixes the terms of railway line and track.

Net cost service contracting A form of tendering of single or bundles of routes where all fare box revenue is kept by the operator.

Pendulum line is a line that passes through a city centre and continues to an area at the opposite outer part of the city. Pendulum lines can also run through a regional or local centre, or a public transport interchange. Pendulum lines combine the two roles of bringing feeder traffic to the urban centre or transport interchange and providing direct connection between opposite districts or corridors of the city.

Quantity licensing An organisational structure in a regulated market in which the number of operators licences are fixed in quantity and leads typically to monopoly rights being established on particular routes.

Quality licensing The imposition of minimum standards of quality being imposed typically on the vehicles and/or operators.

Open market An organisational structure in which any operator is permitted to run any route. In practice this is subject to meeting minimum quality standards.

Region and regional have different meanings in different countries and contexts. In this guide, by region we mean the so-called catchment area of workplaces and regional service functions in one or more urban centres. An urban or city region consists of one or more cities or towns, their suburbs, and the rural hinterland district that is economically and often also administratively and culturally connected to the main urban centre of the region. The definition is a functional one, and not necessarily the same as the administrative, political entity of a regional body between the national and the local government.

Region or regional authority for transport provision can take many forms. The necessary condition is that the authority has some responsibility for a geographical entity where travel patterns are inextricably linked. It need have a specific minimum spatial size as this will depend on the country and location of the region.

Route In this guide the term route is used to describe the series of road or rail links that a public transport vehicle follows through the city and/or region. The public transport services are operated on lines (see above) that may or may not follow the same routes.

Service line A type of bus operation, normally run by minibuses, that is specially designed to serve elderly and disabled persons. The route is planned to reach the most important destinations for this group of users, and in order to reduce walking distances it goes deeper into the local street

system than traditional bus lines. The buses may also stop on demand, and the driver will help passengers that need assistance. Service lines are normally operated with low floor vehicles and have a ramp or lift for wheelchairs.

Skip stop service A bus service that does not call at all designated stops along a route. In this guide the term refers to a planned service. The same type of operation may also be used in response to an incident that disrupts the service on an ordinary line or route.

Transfer The act of changing from one public transport line to another line that may be of the same or different mode of transport. Transfer normally takes place at a designated interchange.



References

Chapter 1

Practical network planning ...

Key references for further study

- Færdselsstyrelsen. Lokal og regional kollektiv trafik – en oversikt. Copenhagen 1998.
- Institute of Transport Economics: Customer oriented public transport. (Summary of results from 500 trial schemes in Norway 1991–1998). Oslo 1999.
- Jonathan Bray Associates: At the leading edge. A public transport good-practice guide. Transport 2000 Trust. London 2003.
- National Audit Office: Improving public transport in England through light rail. Report by the Comptroller and Auditor General. HC 518 Session 2003–2004. 23 April 2004. The Stationery Office, London 2004.
- Stangeby, Ingunn and Norheim, Bård: Fakta om kollektivtransport. Erfaringer og løsninger for byområder. Institute of Transport Economics. Oslo 1995.
- Transek: Bättre kollektivtrafik. Solna 2004.
- Transport Research Laboratory: The Demand for Public Transport: A Practical Guide. TRL report 593. Crowthorne 2004.

Sources

- Brändli, Heinrich and Bolinger, Fredi: Öffentlicher Verkehr im Clinch. Die Unternehmung des öffentlichen Verkehrs im Spannungsfeld zwischen Markt und Politik. VDF – Hochschulverlag AG an der ETH, Zürich (Nationales Forschungsprogramm „Stadt und Verkehr“, ISBN 3-7281-2127-4), 1996.
- Dziekan, Katrin 2003: Easy-to-use public transport. Learning from the mistakes of human beings – a psychological approach. 3rd UITP Conference on Travel Information, Gothenburg 17th–19th September 2003.
- Dziekan, Katrin and Thronicker, Ines: How to enable user orientation in public transport systems? Results of an empirical study in Stockholm, Sweden. Submitted to Environment & Behaviour, 5th of July 2004.

- Holmberg, Bengt, Börjesson, Mats and Peterson, Bo E.: PM om Kollektivtrafikplanering. Lunds Universitet, Lunds Tekniska Högskola, Institutionen för trafik och samhälle, Lund (About public transport planning; in Swedish).
- Hylén, Bertil and Pharoah, Tim: Making tracks – Light rail in England and France. VTI – Swedish National Road and Transport Research Institute, Linköping (VTI-meddelande 926 A) 2002.
- Keller, Hartmut, Tsavachidis, Maria, and Hecht, Christoph: Interconnection of Trans-European Networks (Long Distance) and Regional/Local Networks of Cities and Regions. Final report of the Concerted Action Carisma-Transport. European Commission, DG Tren. Bruxelles 2000.
- Knowles, R. D.: Transport Impact of Manchester's Metrolink Light Rail System. Journal of Transport Geography, vol. 4, pp 1–14, 1996.
- Lange, Truls et al.: Forsøk med visualisering av sammenhengen mellom bystruktur og kollektivtrafikk. Civitas Consultants and Vista utdrøning, Oslo 2002. (Report in Norwegian).
- Mees, Paul: A very Public Solution. Melbourne University Press, 2000.
- Mittasch, Steffen and Oswald, Guy: Unkonventionelle Öffentliche und Paraöffentliche Verkehrssysteme. Einführungsschancen auf Schweizerischen Agglomerationsmärkten. Nationales Forschungsprogramm „Stadt und Verkehr“, Zürich (Bericht 41), 1994.
- Tarzi, George and Last, Andrew: Urban interchanges – A good practice guide. MVA limited, Woking 2000.
- Transport Research Laboratory: The Demand for Public Transport: A Practical Guide. TRL report 593. Crowthorne 2004.

Chapter 2

The institutional context ...

Key references for further study

Colin Buchanan and Partners: Transferability of Best Practice in Transport Policy Delivery. Final Report. Scottish Executive, Transport Research Planning Group. Edinburgh July, 2003.

ISOTOPE: Improved structure and organisation for urban transport operations of passengers in Europe. Office for Official Publications of the European Communities. Luxembourg 1998. ISBN 92-828-3483-2.

Veeneman, Wijnand: Mind the Gap. Delft University Press Science. Delft 2002.

Home page of the Thredbo Conferences on competition and ownership in land passenger transport. www.its.usyd.edu.au/conferences/thredbo

Sources

Aas, Harald: Frankrike satser på trikk og metro, men det koster. Samferdsel nr 1, 2005. (Journal article in Norwegian)

Aas, Harald: Økonomiske incentiver øker kvaliteten på kollektivtrafikken. Samferdsel nr 8, pp 16–17, 2004.

Antilla, Tero: Konkurs og dess konsekvenser i Helsingforsregionen. HST-Busstrafik. Paper at Nordisk lokaltrafikk møte. Oslo, 10–11th June 2004.

Armstrong, Michael: A Handbook of Management Techniques. Kogan Page, London 2001.

Benal, G., Competition in local and regional public transport – A new market in the EU? Diploma Thesis, Vienna Institute for Transport Economics and Logistics 2003.

Bray, D. and Wallis, I.: Competitive Tendering for Bus Services: The Improved Adelaide Model. 7th International Conference on Competition and Ownership in Land Passenger Transport, Molde, Norway, 25–28th June 2001.

Carlquist, E: Incentive contracts in Norwegian local public transport: the Hordaland model. Paper presented to 7th International Conference on

Competition and Ownership of Land Passenger Transport, Molde, Norway, June 2001.

Carlquist, E. and Johansen, K. W.: Local public transport systems. Financial and organisational frameworks in Norway and abroad. Institute of Transport Economics, Oslo. Report 451, 1999.

Catling, D. and Guillosoy, M.: Ease of use of light rail systems. International Association of Public Transport / UITP, The Hague 1995.

Colin Buchanan and Partners: Transferability of Best Practice in Transport Policy Delivery. Final Report. Scottish Executive, Transport Research Planning Group. Edinburgh, July 2003.

Darbera, R.: Deregulation of urban transport in Chile: What have we learned in the decade 1979–1989? Transport Reviews, Vol. 13, no. 1, 45–59. 1993.

Davis, Howard, and Leach, Steve: The Operation of the Metropolitan Passenger Transport Authorities since 1986, Public Money & Management 1991.

Denant-Boemont, Laurent, and Mills, Gordon: Urban light rail: intermodal competition or coordination?, Transport Reviews 1999.

Department for Transport (UK): Study of European Best Practice in the Delivery of Integrated Transport. Report on Stage 3: Transferability. Chapter 5. Institutional and Funding Arrangements. 26th November 2001.

Department for Transport (UK) *website: <http://www.dft.gov.uk>*

Department of Public Enterprise: Bus Regulation in the Greater Dublin Area. Government Publications Office. Dublin 2000.

Department of Public Enterprise: A new institutional and regulatory framework for public transport. Government Publications Office. Dublin 2000.

Department of Environment, Transport and the Regions (UK DETR): Transport Act 2000. London 2000.

Department of Environment, Transport and the Regions (UK) former *website: <http://www.detr.gov.uk/statistics/index.htm>*.

Dodgson, J. S. and Topham, N.: Bus Deregulation and Privatisation. Avebury, Aldershot 1988.

- Duthion, B., Vincent, P. and Ziv, J.-C.: The 'Sapin' Legislation and its effects on tendering and competition in public transport in France. 6th International Conference on Competition and Ownership in Land Passenger Transport, Cape Town, South Africa, September 1999.
- European Commission: Improved structure and organisation for urban transport operations of passenger in Europe. ISOTOPE Final Report. Luxembourg 2000a. ISBN 92-828-8457-0.
- European Commission: Proposal for a regulation of the European Parliament and of the Council on action by Member States concerning public service requirements and the award of public service contracts in passenger transport by rail, road and inland waterway. COM (2000) 7 Provisional. Brussels 2000b.
- European Commission: Quality approach to tendering urban public transport operations. QUATTRO Final Report. Luxembourg 1998. ISBN 92-828-5009-9.
- European Conference of Ministers of Transport (ECMT): Implementing Sustainable Urban Travel Policies. OECD/ ECMT. Paris 2002.
- Fairhurst, M. and Edwards, D.: Bus travel trends in the UK . Transport Reviews, vol. 16, no. 2, pp 159–170. 1996.
- Finn, B. and Nelson, J. D.: An international perspective on the changing structure of the urban bus market. Transportation Research Record, 1799, pp 89–96. 2002.
- Finn, B. and Nelson, J. D.: A Functional Model for an Urban Passenger Transport Authority. 8th International Conference on Competition and Ownership in Land Passenger Transport, Rio de Janeiro, September 2003.
- Fouracre, P. R., Allport, R. J., and Thomson, J. M.: The Performance and Impact of Rail Mass Transit in Developing Countries. Transport and Road Research Laboratory, Research Report RR278. Crowthorne (UK) 1990.
- Gwilliam, K.: Public transport in the developing world – quo vadis? 6th International Conference on Competition and Ownership in Land Passenger Transport, Cape Town, South Africa, September 1999.
- Gwilliam, K., Kumar A. J. and Meakin, R. T.: Designing competition in urban bus passenger transport – lessons from Uzbekistan. 6th International Conference on Competition and Ownership in Land Passenger Transport, Cape Town, South Africa, September 1999.
- Hensher, David A., and Beesley, Michael T.: Contracts, Competitive Bidding and Market Forces: Recent Experience in the Supply of Local Bus Services. Australian Economic Papers. 1989.
- Hensher, D and Stanley, J. K.: Performance based quality contracts. Institute of Transport Studies, University of Sydney. 2002.
- HiTrans Partner Study: Study of HiTrans Partner Cities and Regions – Final Working Document. HiTrans Strand 2, 2004.
- Institution of Highways and Transportation (IHT): Transport and the Urban Environment. London 1995.
- ISOTOPE: Improved structure and organisation for urban transport operations of passengers in Europe. Office for Official Publications of the European Communities. Luxembourg 1998. ISBN 92-828-3483-2.
- Jansson, Kjell: Welfare and markets in passenger transport. International Journal of Social Economics, vol. 23, p 120. 1996.
- Karl, Astrid: Öffentlicher Verkehr im künftigen Wettbewerb. Wie ein inkonsequenter Ordnungsrahmen und überholte Finanzierungsstrukturen attraktive öffentliche Angebote verhindern. Projektgruppe Mobilität, Wissenschaftszentrum Berlin für Sozialforschung gGmbH (WBZ), Berlin.
- Kennedy, D.: London bus tendering – an overview. Transport Reviews, vol. 15, no. 3, pp 253–264, 1995.
- Lätta spår nr 3, Väg- och trafikinstitutet, Linköping 2002. (Light rail information bulletin, in Swedish).
- Mageean, J. F., Rackliff, T., Wright, S. D., Mulley, C. and Nelson, J. D.: European Public Transport – Review of Transport System Organisation. Transport Programme Project No. ST-96-SC.401 Contract

- Report 9. Commission of the European Communities. Bruxelles, May 1998.
- Mulley, C. and Nelson, J. D. : The presence of ITS: The implications for the business case versus the social CBA evaluation for investment. *ITS Journal*, vol. 6, pp 69–82. 2000.
- National Audit Office: Improving public transport in England through light rail. Report by the Comptroller and Auditor General. HC 518 Session 2003–2004. 23 April 2004. The Stationery Office, London 2004.
- Nielsen, Gustav and Ringquist, Stenerik: Erfaringer og potensial ved regional samordning av kollektivtransport Erfaringer fra Göteborg- og Helsingfors-regionene samt eksempler på potensielle gevinster av bedre samordning i Osloregionen. Oslo 2004. (Report in Norwegian).
- Norheim, B. and Carlquist, E.: Markedseffektiv kollektivtransport? En analyse av utviklingen i Oslo, Bergen, Trondheim, Kristiansand og Tromsø. Institute of Transport Economics. Report 428. Oslo 1999.
- Norheim, B. and Frøysadal, E.: Markedsorientert statistikk for kollektivtransport. Institute of Transport Economics. Report 696. Oslo 2003.
- Obeng, K. and Azam, G. : Subsidy Induced Allocative Distortion in Urban Transit Firms. *Journal of Transport Economics and Policy*, pp 193–290, May 1997.
- Passenger Transport Executive Group (PTEG): Newsletter no 3 (downloaded from www.pteg.net). Leeds, September 2003a.
- Passenger Transport Executive Group (PTEG): Delivery of better bus services in conurbations. PTEG Viewpoint (downloaded from www.pteg.net). Leeds, October 2003b.
- Pina, V. and Torres, L.: Analysis of the efficiency of local government services delivery. An application to urban public transport. *Transportation Research A*, vol. 35, pp 929–944. 2001.
- Pucher, J.: Urban transport in Germany: Providing feasible alternatives to the car. *Transport Reviews*, vol. 8, no. 4, 1998.
- Regional Environment Centre: Good Practices in Transport Telematics Implementation. Final report to the EU Commission from the CAPE project. 1999.
- Rothengatter, Werner: Obstacles to the use of economic instruments in transport policy. Ch. 5 in 'Internalising the social costs of transport', OECD/ECMT, Paris 2000.
- Robbins, D.K. and White, P.R.: The experience of express coach deregulation in Great Britain. *Transportation*, vol. 13, pp 359–384. 1986.
- Santos, E., Ramos, R. and Filho, R.O.: Public transport by vans: Facts, meaning and perspectives of its presence in Brazilian cities. 7th International Conference on Competition and Ownership in Land Passenger Transport, Molde, Norway, 25–28th June 2001.
- Seip, Didrik: Forutsetninger og konsekvenser av konkurranse. Paper at Nordisk lokaltrafikk møte. Oslo, 10–11th June 2004.
- SORT-IT/MINIMISE: Joint Final Deliverable. Transport Programme Project No. ST-95-SC.402/ST-96-SC.401 Contract Report 8/14. Commission of the European Communities. Bruxelles, October 1999.
- Toner, J.P.: The London Bus Tendering Regime – Principles and Practice, 7th International Conference on Competition and Ownership in Land Passenger Transport, Molde, Norway, 25–28th June 2001.
- Transecon Consortium: Final Report, Growth Programme project no GMA1-2000-27409. Contract Report No 7. Commission of the European Communities, Brussels, March 2004.
- Van der Maas, C.: Werkt marktwerking? Reported in Buchanan (2003) op cit. Netherlands Ministry of Transport. The Hague 1998.
- Van de Velde, D.: Organisational forms and entrepreneurship in public transport. *Transport Policy*, vol. 6 (3), pp 147–157, 1999.
- Veeneman, Wijnand: Mind the Gap. Delft University Press Science. Delft 2002.
- Vigar, G., Steele, M., Healey, P., Nelson, J. D. and Wenban-Smith, A.: Transport Planning and Metropolitan Governance: Institutional issues in im-

- plementing a new agenda for transport. Landor Publishing, London 2000. (ISBN 1-899650).
- Wallis, I. and Gale, J.: Economic incentives to increase public transport patronage – the theory and the practice. 7th International Conference on Competition and Ownership in Land Passenger Transport, Molde, Norway, 25–28th June 2001.
- Waters, J. and Cloete, J. J.: An appraisal of the tender for contract system in the commuter bus industry in South Africa. 7th International Conference on Competition and Ownership in Land Passenger Transport, Molde, Norway, 25–28th June 2001.
- White, P. R.: What lessons can be drawn about bus deregulation in Britain? *Transport Reviews*, vol. 17(1), pp 1–16, 1997.
- Wieser, Robert: Wettbewerb im Öffentlichen Personennah- und Regionalverkehr. *Wifo Monatsberichte* 3, 2002.
- World Bank, Department for International Development: Review of Urban Public Transport Competition – Draft Final Report”, prepared by Halcrow Fox. Washington, 2000.

Chapter 3 Network structure design

Key references for further study

The literature search has not revealed any comprehensive studies or reports that have their main focus on the topic of public transport network design. Nevertheless, there are some good practice guides on public transport development that might be useful as background reading, even if their main emphasis is on other aspects of public transport system development.

- Jonathan Bray Associates: At the leading edge – A public transport good-practice guide. Transport 2000 Trust, London 2003. A 119 page, richly illustrated report with references to many real-world examples, mostly from the UK, but also many international examples. In addition to an executive summary, the guide has five main parts: 1. Quality networks. 2. Integration. 3. Information 4. Public transport for all. 5. Winning over the public. Available as a pdf file from www.transport2000.org.uk.
- Land Nordrhein-Westfalen, Ministerium für Wirtschaft und Mittelstand, Technologie und Verkehr: Neue Chancen für den Bus. Aufwand – Nutzen – Perspektiven. Düsseldorf 1999. (In German)
- Transit Cooperative Research Program: Transit Capacity and Quality of Service Manual. TCRP Web Document 6. Washington 1999. Available as pdf files from www.tcrp.org. This is a comprehensive manual, designed to give advice on many technical aspects of public transport systems in the USA; a public transport version of the famous Highway Capacity Manual for road and car traffic planning.
- From the Norwegian Institute of Transport Economics internet site www.toi.no. Since the middle of the 1990s the institute had the leading role of evaluating results from a Norwegian development programme for public transport. Some of the documents with summaries of the experiences from the programme are particularly useful for strategic public transport planning:

Sources

- Apel, Dieter and Pharoah, Tim: Transport Concepts in European Cities. Avebury Studies in Green Research, Ashgate Publishing Ltd, Aldershot (UK) 1995.
- Børjesson, Mats; Petterson, Hans-Åke and Jenstav, Marika: Attraktivare och effektivare kollektivtrafik. Sammanfattning av resultat från projekt stödda av Transportforskningsberedningen. Transportforskningsberedningen, Stockholm 1988. (In Swedish).
- Council of European Municipalities and Regions (CEMR): European Public Transport Award 2002/2003. Bruxelles 2003. Internet site: www.ccre.org.
- Meilof, Joost and Smit, Peter: Cycling in Dutch cities. Ten excursions in the Netherlands. Fietsersbond enfb, Woerden 1993.
- Fredriksson, Lena, Möller, Jens and Wendle, Björn: Attraktiv kollektivtrafik i små städer. Förutsättningar och möjligheter för ett ökat resande. Förstudie. Trivector Traffic AB, Lund and Kommunikationsforskningsberedningen, Stockholm 2000. (KFB-meddelande 2000:18, in Swedish).
- Hovedstadsregionens udviklingsråd (HUR): Bussen holder. En vejledning til brug for vejmyndigheder ved nybygning eller ombygning av busstoppesteder. Copenhagen 2002a. (Planning and design guide in Danish).
- Hovedstadsregionens udviklingsråd (HUR): Bussen kommer. Et vejledende hæfte om bussernes krav til vejanlæg, stoppesteder og terminaler. Copenhagen 2002b. (Planning and design guide in Danish).
- Hovedstadsregionens udviklingsråd (HUR): Vi hjælper bussen frem – fra problem til løsning. Copenhagen 2002c. (Information folder in Danish).
- Hovedstadsregionens udviklingsråd (HUR): Bedre fremkommelighed for busserne betaler sig – eksempler og erfaringer. Copenhagen 2002d. (Information folder in Danish).
- Hovedstadsregionens udviklingsråd (HUR): A-busnettet – fremrykkede stoppesteder. Idékatalog. Copenhagen 2002e. (Planning and design guide in Danish).
- Keller, Hartmut, Tsavachidis, Maria, and Hecht, Christoph: Interconnection of Trans-European Networks (Long Distance) and Regional/Local Networks of Cities and Regions. Final report of the Concerted Action Carisma-Transport. European Commission, DG Tren. Bruxelles 2000.
- Kommunikationsdepartementet: Kollektivtrafik i tätort. Sveriges offentliga utredningar, SOU 1975:47. Stockholm 1975. (In Swedish).
- Marie, Joseph H: Emerging trends in European public transport – Intermodalism: Facilitating modal transfers. Paper presented to the ENO foundation, 2001. (The paper includes case study material for Jönköping and Zürich and some other cases.)
- Mees, Paul: A Very Public Solution. Transport in the Dispersed City. Melbourne University Press. Melbourne 2000.
- Nielsen, Gustav and Ringquist, Stenerik: Erfaringer og potensial ved regional samordning av kollektivtransport Erfaringer fra Göteborg- og Helsingfors-regionene samt eksempler på potensielle gevinster av bedre samordning i Osloregionen. Oslo 2004. (In Norwegian).
- PLANK: Planeringshandbok för kollektivtrafik. Transportforskningsdelegationen, Stockholm 1981. (Handbook in Swedish; one main report and four supplementary reports).
- Ruud, Alberte and Frøysadal, Edvin: Målrettet kollektivtransport. Veileder med oppsummering av kunnskap og eksempler på tiltak. Transportøkonomisk institutt, Oslo 2002. (TØI rapport 587/2002; ISBN 82-480-0276-4; ISSN 0802-0175; in Norwegian).
- Schley, Frank: World Bank Urban Transport Strategy Review. Experiences from Germany and Zürich. Deutsche Gesellschaft für Technische Zusammenarbeit (GTZ) GmbH. Eschborn (D) 2000.
- Transportøkonomisk institutt: Temahefte Målrettet kollektivsatsing. Oslo 2001. (Information publication in Norwegian).
- Vibe, Nils: Bytransport under ulike vilkår. En komparativ studie av sammenhengen mellom bytrans-

portens rammebetingelser og reiseatferd i norske og utenlandske byer. Institute of Transport Economics Oslo 2003. (Report 653; in Norwegian with summary in English).

Chapter 4

Methods and tools ...

Key references for further study

Minken, Harald et al.: Nyttekostnadsanalyser av kollektivtiltak – Veileder. Institute of Transport Economics (report 526a). Oslo 2001. The report is a guide to cost benefit analyses of public transport measures, i.e. infrastructure, operational management and pricing measures, primarily aimed at simple analyses of standard measures. Report 526/2001 from the Institute gives an overview of principles and methods, with a short English summary.

SIKA: Översyn av Samhällsekonomiska metoder och kalkylvärden på transportområdet. ASEK, Sika Rapport 2002:4. Stockholm 2002. Documentation of national assessment procedures in Sweden.

Trafikministeriet: Brug af samfundsøkonomiske analyser i udvalgte lande. Copenhagen 2002. (In Danish). The study gives an overview of the appraisal methods used by the national transport authorities in seven countries; Denmark, Finland, France, Germany, Netherlands, Norway, Sweden and United Kingdom.

Transport Research Laboratory: The Demand for Public Transport: A Practical Guide. TRL report 593. Crowthorne 2004. This is a very useful summary and sourcebook about the factors that affect public transport demand, based on British and international research.

[www/webtag.org.uk](http://www.webtag.org.uk): This is the Department for Transport's website for guidance on the conduct of transport studies. The guidance includes or provides links to advice on how to:

- set objectives and identify problems;
- develop potential solutions;
- create a transport model for the appraisal of the alternative solutions;
- and how to conduct an appraisal which meets the Department's requirements.

The website also includes advice on the modelling and appraisal appropriate for major highway and public transport schemes.

Sources

- Asplan-Viak: Bruk av tilgjengelighetsanalyser i areal- og transportplanlegging. Hovedrapport. Trondheim 1999.
- Beser, M. and Algers, S.: Chapter 9 SAMPERS – the new Swedish National travel demand forecasting tool, in Lundqvist L, and Mattson, L-G, editors, National transportation models – recent developments and prospects, Springer, ISBN 3-540-42426-1.
- Department for Transport (UK) [www/webtag.org.uk](http://www.webtag.org.uk). This is the Department's website for guidance on the conduct of transport studies and assessment of transport projects.
- Department for Transport (UK): Introduction to Transport Analysis. TAG Unit 1.1. London, April 2004.
- Edinburgh City Council: Integrated Transport Initiative for Edinburgh and South-East Scotland. Application to the Scottish Executive for Approval in Principle. Appraisal Summary Table and Technical Report. Edinburgh 2001.
- Fotheringham, A.S. et al.: Geographically weighted regression. John Wiley and Sons Ltd, 2002.
- Helsinki City Transport: Annual Report 2002. Helsinki 2003.
- HM Treasury: Appraisal and Evaluation in Central Government, revised edition. London 2003
- Minken, Harald et al.: Nyttetekostnadsanalyser av kollektivtiltak – Veileder. Institute of Transport Economics, (report 526a) Oslo 2001.
- SIKA: Översyn av Samhällsekonomiska metoder och kalkylvärden på transportområdet. ASEK, Sika Rapport 2002:4. Stockholm 2002.
- Stockholm County Council: The Public Transport Plan 1983–85, Stockholm.
- Tegnér, G., Nilsson, C., Loncar-Lucassi, V. and Holmberg, I.: The demand for Public Transport Trips in Stockholm – a two-stage non-linear times-series model. Paper at the conference Economics and Institutions of Transport, May 25th–27th in Borlänge, Sweden 1998.
- Tegnér, G.: Comparison of Transit Modes at Kungens Kurva, Huddinge, Sweden. Eighth International Conference on Automated People Movers, 8–11 July in San Francisco. Transek, Solna 2001
- Tengblad, Bo: Best-prosjektet – Hva nå? Resultater hittil og veien videre. Paper (in Swedish) at the Nordic Public Transport Meeting, June 10–11. Oslo 2004.
- Transport Research Laboratory: The Demand for Public Transport: A Practical Guide. TRL report 593. Crowthorne 2004.
- Transek and Skanska: Tvärsparvåg Nord och Syd. Stockholm 1988.
- Transek: Stockholm Transit Company. Factors explaining ridership development 1997–2001. Transek Consultants Report (in Swedish). Solna 2002.
- Transek: A Better Public Transport in the Future. Vinnova research report (in Swedish). Stockholm 2004.
- Transek/EDICT: European Demonstration of Innovative City Transport (EDICT): Site Assessment Report Huddinge. Solna, April 2004.



HiTrans Best practice guide 2
Public transport – Planning the networks

ISBN 82-990111-3-2

HiTrans 2005
www.hitrans.org

Layout and cover design
Truls Lange Civitas

Printed by Hestholms Trykkeri AS, Skytta, Norway
Bound by Lundeby Bokbinderi AS, Hærland, Norway

HiTrans

HiTrans is an EU sponsored Interreg IIIB (North Sea Region) project seeking to improve public transport in medium sized cities with 100,000–500,000 inhabitants. The full official project title is *Development of principles and strategies for introducing High Quality Public Transport in medium sized cities and regions*. “High Quality” refers to modes that are perceived as offering higher quality than ordinary bus-solutions. However HiTrans also recognises the important role buses will have to play in any medium sized city.

HiTrans is a partnership between

- Rogaland County Council, Norway (lead partner),
- Edinburgh City Council, Scotland,
- Helsingborg City Council, Sweden,
- Jernbaneverket
(The Norwegian National Rail Administration),
- NEXUS (PTE of Tyne and Wear), England,
- NSB (Norwegian National Rail Operator),
- AS Oslo Sporveier (Oslo public Transport Ltd), Norway,
- Statens vegvesen
(Norwegian public Roads Administration),
- Stavanger and Sandnes City Councils, Norway,
- Sunderland City Council, England,
- Aarhus County Council, Denmark.

For more information on HiTrans, visit www.hitrans.org

HiTrans best practice guides

As part of its activities, the HiTrans partnership has produced five best practice guides:

- 1 Public transport & land use planning
- 2 Public transport – Planning the networks
- 3 Public transport & urban design
- 4 Public transport – Mode options and technical solutions
- 5 Public transport – Citizens’ requirements.

2

Best practice guide 2

Public transport – Planning the networks

This guide gives advice on how to plan and design optimal public transport networks for medium sized cities. It also discusses various legislative and political frameworks, and their effects on the provision of public transport as well as on the planning of it. In addition, the guide provides an overview of various methods and tools for assessing public transport schemes.

Authors

Gustav Nielsen (Civitas Consultants, Norway) with John D. Nelson and Corinne Mulley (University of Newcastle, England), Göran Tegnér (Transek AB, Sweden), Gunnar Lind (Stratega AB, Sweden) and Truls Lange (Civitas Consultants, Norway), who has also been responsible for the document design and the illustrations.

Other contributors were Axel Kühn, Germany, expert advice, Ian Radbone, R&D Policy Development, Australia, editorial advice, and the HiTrans partners.